

SAINT PAUL COLLEGE

start here. go anywhere.



2019–2020 CATALOG



235 Marshall Avenue - Saint Paul, MN 55102 • 651.846.1600 • saintpaul.edu

SAINT PAUL COLLEGE

start here. go anywhere.

2019–2020 Catalog

Saint Paul College—A Community & Technical College reserves the right to change requirements of this catalog as a result of state and federal legislation, policies of the Minnesota State Colleges and Universities Board of Trustees, and other reasons deemed necessary by the faculty and administration.

AVAILABLE IN ALTERNATE FORMAT to individuals with disabilities by contacting 651.846.1547 or AccessResources@saintpaul.edu. This document is available electronically at saintpaul.edu/catalog.

The name of the organization is Saint Paul College—A Community & Technical College, hereinafter referred to interchangeably as “the College” in policy and procedure statements.

Saint Paul College—A Community & Technical College is committed to a policy of nondiscrimination in employment and education opportunity. No person shall be discriminated against in the terms and conditions of employment, personnel practices, or access to and participation in, programs, services, and activities with regard to race, sex, color, creed, religion, age, national origin, disability, marital status, status with regard to public assistance, sexual orientation, gender identity, gender expression, or membership or activity in a local commission as defined by law.

Harassment of an individual or group on the basis of race, sex, color, creed, religion, age, national origin, disability, marital status, status with regard to public assistance, sexual orientation, gender identity, gender expression, or membership or activity in a local commission has no place in a learning or work environment and is prohibited. Sexual violence has no place in a learning or work environment. Further, Saint Paul College shall work to eliminate violence in all its forms. Physical contact by designated College staff members may be appropriate if necessary to avoid physical harm to persons or property.

Saint Paul College is committed to fostering an environment without discrimination and harassment. The College has a complaint process to review complaints of discrimination, harassment and sexual violence. Inquiries regarding compliance to Federal and State Laws and Statutes may be addressed to the Vice President of Student Affairs.

Refer to the Saint Paul College Student Handbook for important information that each student should read to assure success at the College.

Table of Contents

Message from the President

Welcome to Saint Paul College. 1

Saint Paul College: Vision, Mission & Values

Saint Paul College: Vision, Mission & Values. 2

Strategic Goals 3

General Information and Services

General Information 5

One Stop 6

Registration 10

Tuition and Fees 12

Financial Aid 14

Educational Programs 18

Minnesota Transfer Curriculum 21

Programs

Business. 31

Career & Technical Education 63

Health Science. 95

Service 146

STEM: Science, Technology, Engineering & Mathematics. 169

Liberal & Fine Arts 206

Course Descriptions

Course Descriptions 224

Stakeholders

Board of Trustees. 289

President's Advisory Council 289

Foundation Board of Directors 290

Administration 291

Academic/Student Support. 292

Faculty 294

Index

Index 300

Directions and Parking

Directions and Parking to Saint Paul College 303

Parking Information. 304

Information Directory

College Calendar 2019-20

General Information 651.846.1600
TTY – Minnesota Relay 7-1-1 or1.800.627.3529
Fax 651.846.1703

Academic Divisions:

Career & Technical Education Division 651.846.1609
Business Division 651.846.1609
Health Science & Service Division 651.403.4128
Liberal Arts & Fine Arts Division 651.846.1349
Science, Technology, Engineering,
Math (STEM) Division 651.846.1349
Access & Disability Resources 651.846.1547
saintpaul.edu/AccessDisabilityResources
Alumni Relations 651.846.1469
saintpaul.edu/Alumni
Assessment, Intake 651.846.1555
saintpaul.edu/Assessment
Bookstore 651.846.1422
saintpaulcollegebookstore.com
Care Team 651.846.1357
saintpaul.edu/CareTeam
Career Services 651.846.1384
saintpaul.edu/CareerServices
Counseling 651.846.1383
saintpaul.edu/Counseling
English for Academic Purposes (EAPP) 651.846.1555
Financial Aid 651.846.1386
saintpaul.edu/FinancialAid
Foundation/Friends of Saint Paul College 651.846.1469
saintpaul.edu/Friends
IT Services/Help Desk 651.846.1440
saintpaul.edu/HelpDesk
Library/Learning Commons 651.846.1646
Make It Count 651.846.1325
One Stop 651.846.1555
saintpaul.edu/Apply
Pathway Advising 651.846.1739
saintpaul.edu/AcademicAdvising
Public Safety 651.846.1322
saintpaul.edu/PublicSafety
Power of YOU 651.846.1325
Student Life & Diversity Office 651.846.1659
saintpaul.edu/StudentLife
Student Records 651.846.1515
saintpaul.edu/StudentServices
TRIO (Student Support Services) 651.403.4147
saintpaul.edu/Trio
Tuition Office 651.846.1395
saintpaul.edu/Tuition
Tutoring Services 651.846.1623
saintpaul.edu/Tutoring
Veterans Educational Benefits 651.403.4211
Vice President of Academic Affairs 651.846.1333
Vice President of Student Affairs 651.846.1333

FALL SEMESTER

August 26, 2019 – December 20, 2019

Tuition Due Date 8/5/2019
FALL SEMESTER BEGINS 8/26/2019
Final Date to Change Fall Semester Registration 8/30/2019
Labor Day Holiday – COLLEGE CLOSED 8/31 – 9/2/2019
Saturday Classes Begin 9/7/2019
Final Date to Withdraw for Tuition Adjustment* 9/23/2019
Spring Semester 2020 Priority Registration Begins . 10/16/2019
Current Students
NO CLASSES 10/17 – 10/18/2019
Final Date to Apply for Fall Semester Graduation . . 10/31/2019
Spring Semester 2020 Registration Begins 11/1/2019
New Students
Summer Term 2020 Registration Begins 11/1/2019
Veterans Day Holiday – COLLEGE CLOSED. 11/11/2019
Final Date to Withdraw to Receive "W"Varies
Withdrawal date varies. Check online course schedule.
Thanksgiving Holiday – COLLEGE CLOSED. 11/28 – 12/1/2019
Saturday Classes End 12/14/2019
FALL SEMESTER ENDS 12/20/2019

SPRING SEMESTER

January 13, 2020 – May 15, 2020

Tuition Due Date 12/19/2019
SPRING SEMESTER BEGINS 1/13/2020
Final Date to Change Spring Semester Registration . 1/17/2020
Saturday Classes Begin 1/18/2020
Martin Luther King Holiday – COLLEGE CLOSED . . . 1/20/2020
Final Date to Withdraw for Tuition Adjustment* 2/10/2020
Presidents' Day Holiday – COLLEGE CLOSED 2/17/2020
Professional Development 2/18/2020
Classes starting at or after 4:00 pm will be held.
Final Date to Apply for Spring Semester Graduation . 2/28/2020
Fall Semester 2020 Priority Registration Begins 3/10/2020
Current Students
SPRING BREAK 3/16 – 3/21/2020
Final Date to Apply for Summer Graduation 3/27/2020
Fall Semester 2020 Registration Begins 4/3/2020
New Students
Final Date to Withdraw to Receive "W"Varies
Withdrawal date varies. Check online course schedule.
Saturday Classes End 5/9/2020
Graduation Ceremony 2019/2020 5/14/2020
SPRING SEMESTER ENDS 5/15/2020

SUMMER TERM

May 26, 2020 – July 31, 2020

Tuition Due Date 5/4/2020
SUMMER TERM BEGINS 5/26/2020
Final Date to Change Summer Term Registration 6/1/2020
Final Date to Withdraw for Tuition Adjustment* 6/8/2020
Check online course schedule.
Independence Day Holiday
– COLLEGE CLOSED 7/3 – 7/5/2020
Final Date to Withdraw to Receive "W"Varies
Withdrawal date varies. Check online course schedule.
SUMMER TERM ENDS 7/31/2020

* Tuition refund is pro-rated for a complete withdrawal from the College.

Welcome to Saint Paul College



At Saint Paul College, our first priority is to provide students with an exceptional education. We provide the opportunities for multiple pathways, and the students themselves mold these opportunities into their personal successes.

Choose from over 100 degree, diploma and certificate programs Liberal and Fine Arts, Business, Career and Technical, Health Sciences, Service, and STEM programs. Our faculty are experts in their fields, and will challenge you and inspire you to excel in your chosen career and educational path.

Our students' accomplishments are attained through their own perseverance, fortitude and commitment to fulfilling their own dreams and their own definition of success. That's why I think of Saint Paul College as being at the intersection of opportunity and success.

We are an award winning, technologically savvy campus. I would like to personally invite you to visit our beautiful campus, take a tour and see our classrooms, labs and hands-on training facilities, especially our new Health Sciences Simulation Center.

I have long been an advocate for community and technical colleges - I started my college education at a two-year college, and that experience made an incredible impact on my life. Join the over 10,000 students who attend classes at Saint Paul College, and experience the benefits of attending a community college. We are a vibrant campus community where we celebrate our differences and commonalities

On behalf of our faculty, staff and administrators, I want to thank you for considering Saint Paul College as your educational partner and your pathway to a bright future. We look forward to working with you each step of the way. Best wishes for success with your college plans and your personal goals.

Sincerely,

Rassoul Dastmozd, Ph. D.
President/CEO

MISSION

Education for Employment ... Education for Life!

Saint Paul College offers comprehensive learning opportunities in career and transfer education to enhance personal knowledge and advance economic opportunity for the benefit of a diverse population including students, business/industry/labor and the community.

VISION

Saint Paul College will be a leader in providing comprehensive lifelong learning through innovative and quality focused strategies and services.

VALUES

The College's mission and vision are based on its values which are central to an effective learning organization. Saint Paul College—A Community & Technical College is committed to the following values.

EXCELLENCE

Teaching & Learning | Career & Transfer Education
Student-Focused Services | Innovation
Accessibility | Technology

INTEGRITY

Honesty | Accountability
Decision-Making | Climate Responsiveness

RESPECT

Student-Centered | Cultural Diversity/Inclusiveness
Human Diversity | Collaboration

ACCREDITATION

Saint Paul College—A Community & Technical College is accredited by The Higher Learning Commission of the North Central Association of Colleges and Schools. The College also holds professional accreditation from: Accreditation Council for Business School and Programs (ACBSP), Accreditation Council for Pharmacy Education (ACPE), Accreditation Commission for Education in Nursing (ACEN), American Culinary Federation Education Foundation's Accrediting Commission (ACFEF), American Society of Health-System Pharmacists (ASHP), Comite'International d' Esthetique et de Cosmetologie (CIDESCO), Commission on Accreditation for Health Informatics and Information Management Education (CAHIIM), Commission on Accreditation for Respiratory Care (CoARC), National Accrediting Agency for Clinical Laboratory Sciences (NAACLS), National Automotive Technicians Education Foundation (NATEF), and National Institute for Metalworking Skills (NIMS).

Saint Paul College meets established standards and is approved for the instruction of veterans, orphans of war veterans, state and federal rehabilitation students and members of the workforce needing training or retraining. Saint Paul College meets the definition of an institution of higher education and students are entitled to participate in federal financial assistance programs.

Strategic Goals

GOAL 1: Provide an inclusive and welcoming environment that maximizes comprehensive high-quality learning programs and services.

Saint Paul College is student-centric, committed to excellence in teaching and learning, and offers a wide spectrum of support services, learning opportunities, and delivery methods in education to address learners' current and future needs.

1. Provide seamless, comprehensive learning opportunities through innovative academic programs and services for diverse learners and development and recruitment of excellent faculty.
2. Apply technology to enhance teaching and learning to maximum effect.
3. Continually assess and improve academic programs, student services, student success and retention strategies, and instructional effectiveness and excellence.
4. Maintain current and pursue new national, regional, and professional accreditation.

GOAL 2: Expand opportunity and support to increase learner persistence and success.

Saint Paul College is dedicated to an integrated service philosophy that recognizes learners' various identities and creates an inclusive environment to meet their needs.

1. Use multiple measures to holistically assess learners' preparedness for college.
2. Collaborate interdepartmentally and with community-based organizations to provide support services and resources that promote learner success.
3. Implement processes consistently across all departments to foster learner persistence and success.
4. Partner with secondary and post-secondary institutions to increase educational opportunities for learners.

GOAL 3: To be the partner of choice for both business/industry and community based organizations by purposely strengthening these partnerships.

Saint Paul College is committed to meeting community and workforce needs of the region by fostering strong partnerships with businesses, industry, and community based organizations.

1. Promote the College as a key provider of high-quality, life-long learning for employment and/or transfer.
2. Provide continuing education, and short-term training, to meet workforce and community needs.

3. Build and sustain strong relationships/partnerships with alumni, local, state, regional, national and international businesses and other constituents.
4. Develop and expand outreach services and partnerships to support economic and community vitality.
5. Provide the business community with diverse, high-quality workforce talent.
6. Use formative and summative assessment tools to ensure programs and trainings are relevant to meet business/industry and partner needs.

GOAL 4: Optimize organizational innovation and development.

Saint Paul College strives to ensure a successful future through creative thinking, intentional partnerships, and the integration of quality professional development opportunities.

1. Build organizational capacity to better anticipate change, meet future challenges, navigate barriers, and create opportunities that foster innovation and responsiveness.
2. Cultivate a campus culture that encourages new ideas, engagement, and collaboration.
3. Inspire alternative instructional approaches and curricular innovation to meet the needs of our diverse and continuously evolving student base.
4. Effectively leverage technology to realize innovative ideas.
5. Commit resources to provide opportunities for creative development, improve learning and operations, and maximize organizational efficacy.

GOAL 5: Sustain financial viability during changing economic and market conditions.

Saint Paul College is committed to ensuring its long-term financial stability.

1. Make budget decisions that reflect priorities in core mission and fiscal stewardship.
2. Utilize sound financial management and assessment practices.
3. Decrease financial risk to the College by pursuing new ways to promote student financial literacy.
4. Expand institutional fundraising to generate additional scholarships, grants, and to grow the College's endowment.
5. Promote financial stability by analyzing and maintaining an appropriate academic program mix between Liberal Arts education and Career and Technical education programs.

General Information and Services

General Information

Accreditation	5
Minnesota State Colleges and Universities	5
Alliances and Memberships	5
Workforce Training & Continuing Education (WTCE)	5

One Stop

Admissions Process	6
Transfer of Credits from Other Institutions	7
Transfer of Credit Policies	8
Additional Types of Credit	8
Background Checks Policy	9

Registration

Registration	10
Course Add, Drop or Withdraw	10
Satisfactory Academic Progress Guidelines	10
Satisfactory Progress Standards	11

Tuition and Fees

Tuition and Fees	12
Tuition Refund Policy	14

Financial Aid

General Information	14
Financial Aid Definitions	14
Types of Financial Aid	15
Work-Study Programs	15
Loans	15
Other Sources of Financial Assistance	15
How to Apply for Financial Aid	15
Financial Aid Policies & Procedures	16
Satisfactory Academic Progress for Financial Aid	17

For information about Financial Aid, please refer to the Saint Paul College Student Handbook or website:
saintpaul.edu/FinancialAid

Services for Students

For information about Services for Students, please refer to the Saint Paul College Student Handbook or website:
saintpaul.edu/StudentServices

Student Life and Diversity

For information about Student Life and Diversity, please refer to the Saint Paul College Student Handbook or website:
saintpaul.edu/StudentLife

Rights and Responsibilities

For information about Rights and Responsibilities, please refer to the Saint Paul College Student Handbook or website:
saintpaul.edu/Rights&Responsibilities

Academic Standards

For information about Academic Standards, please refer to the Saint Paul College Student Handbook or website:
saintpaul.edu/AcademicStandards

Educational Programs

Liberal Arts and Sciences Associate of Arts (AA) Degree	18
Associate of Fine Arts (AFA)	19
Associate of Science (AS) Degree	19
Associate of Applied Science (AAS) Degree	19
Diploma Programs	20
Certificate Programs	20
Developmental Coursework	20
English for Academic Purposes (EAP)	20
Internships	21
Saint Paul Joint Apprenticeship	21

Minnesota Transfer Curriculum

Minnesota Transfer Curriculum Goals	21
Minnesota Transfer Curriculum (MnTC) Course List	23
Transfer to Other Institutions.	28
Transfer Articulation Agreements	28
General Transfer Table 2019-2020	29

GENERAL INFORMATION

Accreditation

Saint Paul College—A Community & Technical College is accredited by The Higher Learning Commission of the North Central Association of Colleges and Schools.

The College also holds professional accreditation from:

- Accreditation Council for Business School and Programs (ACBSP)
- Accreditation Council for Pharmacy Education (ACPE)
- Accreditation Commission for Education in Nursing (ACEN)
- American Culinary Federation Education Foundation's Accrediting Commission (ACFEF)
- American Society of Health-System Pharmacists (ASHP)
- Comite'International d' Esthetique et de Cosmetologie (CIDESCO)
- Commission on Accreditation for Health Informatics and Information Management Education (CAHIIM)
- Commission on Accreditation for Respiratory Care (CoARC)
- National Accrediting Agency for Clinical Laboratory Sciences (NAACLS)
- National Automotive Technicians Education Foundation (NATEF)
- National Institute for Metalworking Skills (NIMS)

Saint Paul College meets established standards and is approved for the instruction of veterans, orphans of war veterans, state and federal rehabilitation students and members of the workforce needing training or retraining. Saint Paul College meets the definition of an institution of higher education and students are entitled to participate in federal financial assistance programs.

Minnesota State Colleges and Universities

Saint Paul College is one of the 31 colleges and universities in the Minnesota State Colleges and Universities system. The colleges in the system provide a wide array of opportunities for lifelong education in academic and technical fields, ranging from short-term certificate programs to doctoral programs. Approximately 33,500 students graduate from Minnesota State Colleges and Universities each year. Refer to the System website www.minnstate.edu for further information.

Alliances and Memberships

Students, Alumni & the Employer Connection

Saint Paul College offers undergraduate programs of two years or less to a widely diverse student population. Students are welcome regardless of their background, experience, or previous educational endeavors. The common goal of all students, however, is their desire for *Education for Employment... Education for Life!*

Alumni Relations

The College sponsors an Alumni Association to complement the educational process. All Saint Paul College graduates are encouraged to join. Call 651.846.1469 or visit saintpaul.edu/Alumni for further information.

Alliances with Business and Industry

Saint Paul College's greatest asset is its success in providing employment opportunity for graduates. This is due to its partnerships with the businesses, industries and trade unions with whom we collaborate. Saint Paul College relies on these major stakeholders to:

1. Hire our graduates;
2. Serve on our Advisory Committees to ensure relevant and current curriculum content and instruction; and
3. Provide quality assurance and identity within the community.

The College's relationships with businesses, industries, trade unions and alumni have remained strong to help ensure that the tradition of quality will be continuously enhanced through information, involvement and improvement.

Workforce Training & Continuing Education (WTCE)

The Workforce Training and Continuing Education division at Saint Paul College serves the non-credit educational and professional development needs of organizations and individuals in the greater metropolitan area. For over 20 years, Saint Paul College's Workforce Training & Continuing Education division has delivered high quality workforce training and continuing education ranging from development of assessments to consulting with business to meet industry, government, non-profit organizations, entrepreneurs, and individual needs, resulting in recognized credentials that boost performance and career opportunities. We are committed to your organizational and individual success!

Workforce Training

Workforce training provides quality training programs delivered at your location, online or on campus. We assist businesses and organizations in staying informed and knowledgeable about advances and best practices pertinent to workplace skills, leadership, organizational sustainability, and business solutions.

Training is provided in the format that best meets the needs of the client, for example:

- Offering over 100 unique courses through Web-based training.
- Presenting seminars on pertinent and timely topics for industry partners and individual professional development.
- Designing hands-on experiential workshops to promote application of newly acquired behaviors, attitudes, or skills.
- Enhancing skills or specific knowledge relating to career and professional development through continuing education courses.

Continuing Education

Continuing Education provides adult learners the opportunity to enroll in non-credit courses that build career related skills for personal or professional enrichment. Choose from online or classroom-based courses in a variety of fields and content areas.

Examples of training offered through WTCE:

- AutoCAD Training
- Business Management
- Business Writing
- Coaching
- Communication Skills
- Computer Applications
- Customer Service
- Entrepreneurship
- Esthetics Re-licensure & Training
- Health Care
- Leadership/Management
- Motorcycle Training
- Quality Assurance
- Safety
- ServSafe® Certification
- Software Training
- Supervisory & Management Training
- Welding
- Workers Compensation

All WTCE classes can be offered at your work site or custom tailored to meet your employees' needs. Call 651.846.1800 or visit saintpaul.edu/WTCE for more information.

ONE STOP

Admissions Process

Admission to the College is open to students who are at least sixteen years of age, have completed their high school diploma, GED, or equivalent, or meet Ability to Benefit requirements, and who are able to benefit from the educational offerings of the College. Admission to the College does not guarantee admission into a specific program or college-level classes. Clear and accessible information regarding college program admission requirements shall be provided in One Stop and in other locations. Academic, fiscal and facilities considerations may limit admission to a particular program. The exception to this policy relates to those Minnesota high school students who meet the requirements of the Post-Secondary Enrollment Options (PSEO) Act of 1985 (See Minnesota State Policy 3.5) or other special high school programs.

Admission to a Major Program

Students are accepted into a major program for the purpose of obtaining a specific degree, diploma, or certificate. Students may change their major by meeting the prescribed admission requirements for the desired program. Some programs have a separate application process. For more information about specific majors, please check the Program Requirement Guides.

Application Procedure

If you have not applied to or enrolled at Saint Paul College in the past, follow this application procedure:

1. Complete an Application for Admission online at saintpaul.edu/apply.
2. There is a one time, non-refundable \$20 application fee. Saint Paul College is currently waiving this fee.
3. Complete the Assessment in Reading and Math or complete the English as a Second Language (ESL) Assessment if you are a nonnative speaker of English. Call 651.846.1555 for more information. Scores must be turned in to One Stop. A student may be exempted from taking this Assessment based on documentation of subject area test scores on the ACT, SAT, or MCA. If you have taken the ACT, SAT, or MCA test within the last five (5) years, please bring a copy of your scores to One Stop (Room 1300) for further review.
4. Request high school transcripts and/or GED scores, as well as official transcripts from all secondary and post-secondary institutions attended be sent to Saint Paul College.
5. If you have previously applied, enrolled, or requested information from Saint Paul College please contact One Stop so your records can be updated.

Some major programs require additional assessment. Applicants will be notified if their program requires additional assessment. Assessment requirements may be waived based on previous college experience as validated by college transcripts or determined by the One Stop Staff.

Intake Assessment

Research shows that students who enter courses at the level that best matches their background and abilities are more successful. Therefore, Saint Paul College and Minnesota State colleges and universities require assessment of basic academic skills. The assessment for those whose native language is English covers reading comprehension and mathematical computation. The assessment for students whose native language is not English is the English as a Second Language (ESL) assessment. You may be assessed in additional subjects for admission to selected programs or placement into certain courses.

The assessments are computerized and available on a walk-in basis in the Assessment Center -- room 3140 -- and usually take from 1 ½ to 2 ½ hours. Scores determine course placement. In some cases, assessment results may indicate that you may benefit from developmental coursework in reading, writing, grammar, and/or math, prior to entering your major program.

Students are granted two attempts at the assessment each calendar year. There is no cost for the first attempt. The second attempt carries a fee of \$5.00. Students who want to review before taking the exam can access the following websites:

- www.testprepreview.com
- www.math.com
- www.khanacademy.com
- accuplacer.collegeboard.org
- www.testpractice.net

The assessment requirement may be waived depending on previous college experience and/or college coursework. Contact One Stop at 651.846.1555 to have previous college coursework reviewed for an assessment waiver. Please call 651.846.1555 for additional information about the assessment process.

Immunization Requirements

Minnesota Law (M.S. 135A. 14) requires that all students born after 1956 and enrolled in a postsecondary educational institution be immunized against measles, rubella, mumps after the age of 12 months and against diphtheria and tetanus within 10 years of first registration, allowing for certain specified exemptions. You must submit a statement indicating the month and year of each immunization when you register for classes, or no later than 45 days after the start of your first semester. Students born in 1956 or before are not required to provide information. Students who graduated from a Minnesota high school in 1997 or later are also exempt.

The Immunization Record form is designed to provide the College with the information required by law and will be available for review by the Minnesota Department of Health. The form is available on the College website.

Students enrolled in Health programs are required to obtain additional immunizations in accordance with clinical site policy. For more information regarding immunization requirements and resources available to meet those requirements, contact the Dean of Health Sciences and Service Programs.

Application Procedure for Transfer Students

Students seeking admission to Saint Paul College based on previous college coursework should contact One Stop - Room 1300 651.846.1555 after completing the online application.

Students seeking a degree, diploma or certificate, who have previously attended accredited institutions, must have all official transcripts sent directly from the previous colleges to the Saint Paul College Records Office. If a transcript is hand carried by the student, it is to be delivered in a sealed envelope. Student copies and faxed transcripts are not considered official but can be used for admission purposes.

Re-Admission

Students who have interrupted attendance at Saint Paul College must contact One Stop to apply for re-admission. To have assessment tests waived based on coursework completed at another institution, contact One Stop at 651.846.1555.

Undeclared Students

Undeclared students are not assigned an advisor and do not qualify for financial aid or veterans educational benefits. Some classes may be limited to students admitted to a specific major. If at a later date a student decides to pursue a degree, diploma, or certificate, the credits earned as an undeclared student may apply toward a program.

Change of Major

Students who have been admitted to Saint Paul College in a specific major and want to change that major must complete the Change of Major Form at One Stop. Mid-semester major program changes are not permitted. The change of major program will be effective for the next semester.

Post-Secondary Enrollment Options Program (PSEO)

The PSEO program enables eligible Minnesota high school sophomores, juniors and seniors to take college classes for credit. The purpose of the program is to promote rigorous academic pursuits and provide a wider variety of options than may be available in high school. Eligible students may attend either part-time or full-time. Tuition, fees and textbooks are provided at no cost to the student. For more information about the PSEO program, please contact the PSEO Coordinator at 651.846.1713. Please identify yourself as a PSEO student.

High School Articulated Credit

Articulated Credit affords high school students an opportunity to receive college credit in many subjects. Articulated Credit programs effectively blend academic and technical education in a challenging and purposeful course of study that can lead to employment and credit toward further education. Since the workplace has changed significantly enough to require some training after high school, but not necessarily a full four-year degree, articulated credit programs offer viable new options for high school students who want to connect learning with life. Programs are articulated between Saint Paul Public Schools and Saint Paul College. Consult a high school counselor for more information concerning Articulated Credit.

Transfer of Credits from Other Institutions

The College will review requests for transfer of credit from individuals who have completed coursework from other post-secondary institutions. Transfer credits accepted will appear on the Saint Paul College transcript and can be used to satisfy the program graduation requirements but will not be used to calculate the grade point average. Students seeking admission to the College who have attended another college or university and do not meet the College's Satisfactory Academic Progress Standards must appeal for admission.

If you are interested in receiving transfer credit, you must request an official transcript from each institution attended be sent to Saint Paul College - Records Office. If you previously attended a Minnesota State college or university (excludes the University of Minnesota), the Records Office may be able to access your transcript electronically. Contact the Records Office to confirm the availability of a Minnesota State transcript. Each credit to be considered for transfer must be supported by an official transcript from the originating institution and must be approved by the Institution prior to the awarding of credit.

A student shall earn a minimum of 20 credits for all associate degrees at the College. The residency requirement shall be reduced to 12 credits for students transferring with at least 12 college-level credits from another Minnesota State institution and/or the University of Minnesota. One-third of the credits required for a diploma or certificate must be earned at Saint Paul College. At least one course must be completed at Saint Paul College in order to earn the Minnesota Transfer Curriculum (MnTC).

Students also may be eligible to transfer credit to the College through the following:

- AP - Advanced Placement Exams (for high school students)
- CLEP - College Level Examination Program

- Credit for Life Work/Work Experience (Prior Learning)
- IB - International Baccalaureate (for high school students)
- International Credentials
- Military - Related courses and experience

Transfer of Credit Policies

Transfer of credit and courses will be evaluated based on policies and procedures of the College, as outlined in the College's catalog, Minnesota State system policies and procedures, and according to Family Educational Rights and Privacy Act (FERPA).

Institution Accreditation

Transfer of credit will be considered for college level coursework completed at accredited institutions:

- Regionally Accredited: Degree-granting public, private, nonprofit and for-profit, two- and four-year institutions in the United States accredited by the Higher Learning Commission, (a Commission of North Central Association of Colleges and Schools) and/or parallel accrediting agencies in other regions of the United States.
- Nationally Accredited: Specialized institutions, including distance learning providers and freestanding professional schools recognized by the Council of Higher Education Accreditation (CHEA) and the U.S. Department of Education (USDE). Coursework will be considered on a course-by-course basis through an appeal process and will be judged to be comparable or equivalent to courses offered at Saint Paul College.

Transfer Course Evaluation

Courses will be reviewed and considered for transfer as follows:

- General education coursework completed at Minnesota State that fulfills the Minnesota General Education Transfer Curriculum (MnTC) will transfer based on the assigned goal area at the sending institution.
- General education coursework completed at the University of Minnesota or other institutions outside the Minnesota State system will be considered for transfer as:
- Equivalent to a Saint Paul College general education course and MnTC Goal Area
- Not equivalent to a specific Saint Paul College course, but will fulfill a MnTC Goal Area
- Coursework that is not general education will be considered for transfer as:
- Equivalent to a specific course in a technical program (within five years of course completion, if in a technical program)
- Elective credit that does not apply toward general education or technical course requirements (including technical courses over five years old)

Transfer Equivalency

Courses approved for transfer must be comparable in nature, content, and level, and match at least 75% of the content and goals of the course syllabus for which the student is seeking equivalent credit.

Transfer Appeal

If a credit transfer is denied, you may request an appeal. Appeal forms are available online. If you are not satisfied with the results of the appeal, you may appeal to the Vice President of Academic Affairs at the College. A third and final transfer appeal is available at the system level.

Transfer Grades

All college level courses in which a student has received a grade of A, B, C, D or P/S will be considered for transfer evaluation. No F or D- grade courses will be accepted. Please note that while D grades will transfer, some programs require a grade of C or higher for all courses to fulfill requirements.

Time Limit for Courses

General education courses shall have no transfer time limit. Additionally, technical courses applying toward an Associate of Arts (AA) degree shall have no transfer time limit.

To ensure students graduate with up-to-date skills, technical credits are valid for five years or have a five-year "lifespan". This includes transfer technical credits which are used for specific technical program requirements. Technical courses that are beyond the five-year limit may be accepted, based on currency, relevancy and the student's current work experience.

Degree Residency

A student shall earn a minimum of 20 credits for all associate degrees at the College. The residency requirement shall be reduced to 12 college-level credits for students transferring with at least 12 college-level credits from another Minnesota State Colleges and Universities institution or the University of Minnesota. One-third of the credits required for a diploma or certificate must be earned at the College.

Equivalency

The number of transfer credits granted per course shall not exceed the number granted by the originating institution. All quarter credits will be converted to semester credits.

Additional Types of Credit

AP—Advanced Placement Exams (for High School Students)

Advanced Placement (AP) gives high school students an opportunity to take college-level courses in various subject areas. A score of 3 is the minimum for credit awarded. Grades of 3, 4 or 5 qualify students for credits and/or placement into advanced courses at Saint Paul College. There is no limit to the number of credits a student may earn through the AP exams. However, credits earned through Advanced Placement will not satisfy the residency requirement for graduation at Saint Paul College. Credit can be given for a specific college course if a test covers substantially similar material. If the test material does not match an existing course, students will be given elective credits.

CLEP—College Level Examination Program

Saint Paul College will consider CLEP exam credits for students who want to test out of general education courses and selected business courses. There is no limit to the number of credits a student may earn through the CLEP exam. However, credits

earned through CLEP examinations will not satisfy the residency requirement for graduation at Saint Paul College. A student must provide the College with an official report of CLEP examination scores in order to obtain credit. Equivalent courses and required scores can be found on the College website at saintpaul.edu.

Note: Colleges establish their own policies for accepting CLEP credit. Students should consult their transfer college's CLEP policy to determine whether CLEP credits will transfer and/or how they will be accepted. Consult the College Board website www.collegeboard.org for testing locations, fees and exam information.

Credit for Life Work/Work Experience (Prior Learning)

Prior Learning (Competency-Based Education) allows students to present nontraditional learning as competencies to be evaluated for credit by qualified faculty members towards their educational program. These competencies must be the equivalent of what would have been achieved through college coursework. At Saint Paul College, Credit for Prior Learning offers, on a limited basis, students with sufficient work, non-college credit and/or life learning experiences, the opportunity to document competencies and theory learning relevant to specific courses offered at the College. Credits earned from prior learning must be applicable to the student's program of study. The Credit for Prior Learning option may be available for a limited number of courses. Students interested in pursuing the option of earning credit for prior learning must discuss this option with the assigned Faculty Advisor.

IB—International Baccalaureate (for High School Students)

The International Baccalaureate (IB) program is an internationally recognized program through which high school students complete a comprehensive curriculum of rigorous study and demonstrate performance on IB examinations. Students may present a full IB diploma or a certificate recognizing specific higher level or standard level test scores. Credit may be awarded for scores of 4 or higher on individual IB examinations or successful completion of the IB diploma. Credit can be given for a specific college course if an exam covers substantially similar material. There is no limit to the number of credits a student may earn through the International Baccalaureate (IB) program. However, credits earned through International Baccalaureate (IB) will not satisfy the residency requirement for graduation at Saint Paul College.

International Transcripts

Saint Paul College does not evaluate international transcripts. Students who have completed courses in another country must have their transcripts evaluated by a third-party evaluation service. Colleges and universities differ in how they accept these courses.

Military Education and Experience

Saint Paul College will consider academic credit for military education and experience gained while on active duty. The American Council on Education's Guide to the Evaluation of Educational Experience in the Armed Forces will be used to evaluate military education and experience. A copy of the student's Report of Transfer or Discharge (Form DD-214) and an official SMART or AARTS transcript are required for evaluation.

For more information on military transcripts, go to the American Council of Education website at www.acenet.edu and select "Military Students and Veterans" found under "Higher Education Topics."

A maximum of 16 semester technical credits will be accepted as elective credits in transfer from military transcripts. General education credits satisfying the Minnesota Transfer Curriculum (MnTC) will be accepted beyond the 16 semester credit maximum. Students may petition for an evaluation of military credits believed to be equivalent to a specific program.

DANTES—Defense Activity for Non-Traditional Education Support

The DANTES program supports the voluntary educational program for active military personnel and members of the National Guard and Reserves. The DANTES Subject Standardized Tests (DSSTs), however, are now available for use by civilians at universities and colleges throughout the country. The DSSTs are a series of examinations in various college and technical subjects. The DSST program allows students the opportunity to demonstrate college-level learning acquired outside the classroom. All tests carry ACE (American Council on Education) credit recommendations. Saint Paul College will honor the ACE recommendation and accept courses applicable to a program or course of study.

Background Checks Policy

Designated Health and Child Development Careers program students are affected by the following:

Minnesota Statutes require that the Department of Human Services (DHS) conduct background studies on individuals providing direct contact services to people receiving services from facilities and agencies licensed by DHS and the Minnesota Department of Health (MDH). Direct contact is defined as providing face-to-face care, training, supervision, counseling, consultation, or medication assistance to people receiving services from the agency or facility. A fee will be applied for the background check.

An individual who is disqualified from having direct contact with persons served by the program as a result of the background study and whose disqualification is not set aside will not be permitted to participate in a clinical placement in facilities with programs subject to licensure under Minnesota statutes. This is to protect the health, safety and rights of persons served by those programs. Failure to participate in a clinical placement required by the academic program could result in ineligibility to qualify for a degree in this program. The Department of Human Services (DHS) determines disqualification and the Department of Human Services will inform an individual of this report.

Students are reminded of the background study requirement upon admission to the program, during the first introductory course in the program and when a work setting is identified for a clinical placement. Background studies must be submitted annually.

REGISTRATION

The College Course Schedule is available online and contains a complete listing of classes that are available each semester. It is available approximately ten weeks before the beginning of the semester. The Course Schedule lists the courses, number of credits, class times, instructors' names, room numbers and prerequisites. Please note this information is subject to change without notice.

Returning students in a declared major have registration priority. When planning for future courses you are encouraged to work with an Advisor or your program faculty. If you need help in making career decisions, you should make an appointment with the Director of the Career Services. Classes have limited enrollment. Closed classes are posted on the online course schedule.

Registration for classes takes place each semester, including summer semester. Information on how and when to register is sent to new students when they are accepted for admission. Information is also posted on the College website. Not all courses listed in the College Catalog are offered every semester.

A Registration Schedule is published on the College website for each semester and indicates assigned dates and times for registration. Students with an unpaid balance at the College or any other Minnesota State College or University will be unable to register for courses until all unpaid balances have been paid.

Returning students have a variety of resources to assist with course selection, including Pathway Advisors, Degree Audit Reports, and Program Requirement Guides.

Registration Process for Current & Returning Students

1. Review Program Requirements Guide and Degree Audit Report (DARS) and meet with a Pathway Advisor. Select courses.
2. Login into your account to register online; or if assistance is needed, you may go to One Stop for online registration assistance.
3. Pay tuition online or print your fee statement and present it with payment at the Tuition Office before the posted due date. You will receive a paid fee statement upon receipt of payment. Refer to Tuition & Fees for details for payment options.
4. Purchase books and supplies.
5. Attend all courses for which you've registered.

Helpful Hint: Purchase your books prior to the start of class, either at the Bookstore or online at saintpaulcollegebookstore.com. This will help you to avoid the long lines at the Bookstore on the first day of the semester.

Adding, Dropping, or Withdrawing

Students bear primary responsibility for their Course Registrations. Students are responsible for canceling their registration by the due dates posted in the course schedule or to pay any balance due. To cancel registration, a student must login to their e-services account and drop their classes prior to the end of the designated drop/add period. Non-attendance is not a cancellation and students will be held responsible to pay any amount owed.

All students, including those receiving financial aid, will be assessed tuition and fees for the semester based on the number of credits for which they are registered on the 6th day of the semester.

Students may add courses at any time during the published "add" period for each semester. For a course that meets for the full semester, students who drop a course through the 5th day of a semester, may receive a tuition refund (pro-rated for summer semester). The refund schedule varies for courses that meet less than the full semester. Contact the Tuition Office for details on short courses. The add/drop and withdraw deadlines are listed on the course schedule.

Students may withdraw from courses to receive a "W" grade from the 6th day of the semester through the posted date of withdrawal for the semester. For courses that do not run the entire semester, withdrawal is permitted before 80% of the class session is over.

Students must withdraw from courses online in eServices. No refund is permitted after the 5th day. Courses from which a student officially withdraws will be assigned the letter grade "W" (withdraw). Students who fail to withdraw from a course but stop attending before the end of the semester are subject to being assigned a grade of FW. Refer to the current online schedule in eServices for details regarding withdraw dates.

Students who cannot attend class during the first week of classes (or do not plan to log on for the first day of an online class) need to make arrangements in advance for all absences with their instructor. Students who miss class the first week without making prior arrangements with their instructor are subject to being assigned a grade of FN (Failure for Nonattendance). Students must drop courses they do not intend to attend before the end of the add/drop period.

Student Records

The Records Office is the official recorder of student academic records and progress.

Student Transcripts

Requests for Saint Paul College official transcripts are processed through the Student Records Office. All financial obligations to the College must be met before transcripts are released. An official transcript is issued for a fee upon written request or online submission from the college website: saintpaul.edu/student-services/Student-Records. The transcript serves as the official record of student effort while enrolled at the College. Requests are processed within three business days. There is an additional fee for next business day service.

Satisfactory Academic Progress Guidelines

Saint Paul College is dedicated to providing all students with the opportunity to reach their educational goals. Students are responsible for maintaining an acceptable level of academic progress. The Satisfactory Academic Progress (SAP) standards define the GPA and completion rates students must meet.

To support their efforts to meet academic standards, students should attend class regularly and actively engage in the learning process. Students are also expected to monitor their own academic progress. The following standards are used to determine a student's academic status at the end of a semester:

Grade Point Average (GPA) Requirement

- Students must successfully maintain a minimum 2.0 cumulative grade point average.

Completion Rate Requirement

Completion rates are calculated with the first attempted credit and for grades A, B, C, D, and P. Grades of I, F, FN, FW, and W are counted as attempted credits.

- Students must successfully maintain a minimum 67% cumulative completion rate.

Academic Warning

The first time academic standards are not met, the student will be placed on academic warning for the next semester of enrollment. Once the warning is issued, a hold is placed on the student's account. Students must complete the online Academic Warning Agreement Form to have their registration hold removed and are strongly encourage to meet with their Pathway Advisor to develop a success plan to improve their academic standing. Students must earn a minimum 2.0 cumulative GPA and 67% cumulative completion rate while on a warning.

Academic Suspension

Students who fail to meet academic standards in their warning period will be placed on academic suspension for two semesters. All students placed on suspension must appeal to be reinstated. First-semester students who attempt six or more credits and earn grades of all F's, FN's, and/or FW's will be immediately placed on academic suspension.

Appealing Academic Suspension

- Appealing Due to Extenuating Circumstances
- Students who believe they failed to achieve satisfactory academic progress due to extenuating circumstances may file an appeal prior to taking the required two semesters off. However, students must provide documentation supporting their claim of extenuating circumstances interfering with their ability to be successful in school.
- Appealing for Reinstatement After Serving the Required Two Semesters
- Students who have served their suspension period must appeal for reinstatement by completing the Suspension Appeal Packet, which can be obtained in One Stop or via the Saint Paul College website.

Academic Probation

Students with an approved appeal will be reinstated to the College on probationary status. Students will stay on probation and may continue to attend Saint Paul College if they receive a 2.5 GPA and 100% completion for the semester, even if they have not met the cumulative standards.

Once a student has met the cumulative standards (cumulative 2.0 GPA and cumulative 67% completion rate), they will be in good standing and no longer on probation. Students who do not meet the semester standard will be suspended again.

Academic Forgiveness Policy

The Academic Forgiveness policy is available only to students whose coursework was taken at Saint Paul College (formerly St. Paul Technical College). The policy is a one-time opportunity. The student cannot have been enrolled at Saint Paul College for a minimum of two calendar years (24 months) and the student must have a cumulative GPA of less than 2.0. The coursework forgiven will remain on the student's transcript; however, the credits and the grades will not be carried forward into the student's cumulative grade point average. The student will be permitted to select the courses within the semester to be forgiven. Only Ds, Fs, FNs, FWs and Ws can be forgiven. If more than one term is forgiven, they must be consecutive terms. A maximum of two terms may be forgiven. In order to meet eligibility requirements for Academic Forgiveness, the student must have completed a minimum of 12 credits in residence at Saint Paul College with at least a 2.0 GPA after returning from the minimum 2-year absence. The student must apply for Academic Forgiveness within one calendar year after completing the 12 semester credits with at least a 2.0 GPA. Work completed at another institution cannot be used to satisfy this requirement. The student can obtain the Request for Academic Forgiveness at One Stop.

Satisfactory Progress Standards - for financial aid recipients

Federal regulations require that a college develop a standard of satisfactory academic progress. This satisfactory academic progress standard must have both a qualitative standard (grade point average) and a quantitative standard (course completion). If the student fails to meet either of these two standards, the student will first be given a warning semester. If the student fails to meet either of the satisfactory academic progress standards during the warning semester, the student will be suspended from financial aid.

Students who have been suspended from financial aid due to these standards, may receive financial aid again after they have met the satisfactory academic standards or by successfully appealing the loss of aid. Appeal procedures for the loss of financial aid may be found online at saintpaul.edu/financialaid. If the appeal is approved, the student will be placed on probation until both standards have been met. Students bear primary responsibility for their own academic progress and for seeking assistance when experiencing academic difficulty. Students are encouraged to keep a file of their grades and transcripts.

Qualitative Standard

Students are required to maintain a minimum 2.0 cumulative GPA for all coursework including withdrawals, incompletes and non-credit courses. For repeated courses, the highest grade achieved will be used for the GPA. Transfer credits do not affect the student's GPA.

Quantitative Standard

Students are required to complete 67% of the cumulative credits attempted based on their enrollment status. All credits attempted will be calculated into the completion percentage. This includes courses that are designated with a withdrawal, incomplete, non-credit courses and courses that have been repeated. Any coursework that has been accepted as transfer credit toward current program completion will also be included in progress made toward the current program.

Maximum Time Frame

All students are expected to complete their program within an acceptable period of time. Financial aid recipients meeting Satisfactory Academic Progress requirements may receive aid until they complete their program or until they have attempted 150% of the required coursework in their current program/declared major. All credits attempted at the College count toward maximum time frame. This includes withdrawals, incompletes, non-credit courses, and courses that have been repeated. Credits taken under a previous major and transfer credits will count toward maximum time frame.

Implementation

Academic progress is evaluated at the end of each semester. A student who fails to meet cumulative progress requirements will be placed on financial aid probation or suspension.

Academic progress will be monitored as follows:

1. Satisfactory Academic progress monitoring begins with the first credit. Upon six (6) credits of enrollment, all students with registered credits during a semester will be evaluated at the end of the semester.
2. Any student who fails to meet cumulative GPA and completion rate satisfactory academic progress requirements for one semester will be placed on warning for the subsequent semester and will be notified by email. Financial aid may be received during a warning status.
3. A student on warning who fails to meet the required cumulative standards will be suspended from financial aid and notified by email.
4. Upon evaluation, if the College determines that it is not possible for a student to meet the minimum cumulative standards prior to completing a degree/diploma or certificate for their declared major, the student will be suspended from financial aid and will be notified by email.
5. A student who has exceeded the maximum time frame will be placed on suspension from financial aid and will be notified by email.

Suspension for Extraordinary Circumstances

The College may immediately suspend a student in certain circumstances, such as but not limited to:

- A student who was previously suspended and whose academic performance falls below acceptable levels during a subsequent semester
- A student who registered for but does not earn any credits for one semester by earning all FN/FW/F grades
- A student who demonstrates an attendance pattern that abuses the receipt of financial aid.

Financial Aid Appeals

A student who fails to make satisfactory academic progress and is suspended from financial aid has the right to appeal based on unusual or extenuating circumstances, which may include but shall not be limited to a death in the family, student's injury or illness, etc.

Appeals Process

Appeals forms are available online at saintpaul.edu/financialaid. The appeal must include a thorough explanation of the circumstances that affected academic progress and complete "Financial Awareness" counseling on www.studentloans.gov. If applicable, the appeal must include supporting documentation beyond the written explanation. Appeals must be submitted to the Financial Aid Office to be evaluated for an approval or denial. A written decision on the appeal will be provided to the student.

If the appeal is approved, the student may receive financial aid for the next semester. When GPA and/or completion rate requirements for the approved appeal semester are met, the student will remain financial aid eligible. If these requirements are not met for the semester and the student does not meet required standards, the student will be suspended from financial aid eligibility.

Probation

Students who have successfully appealed their suspension will be placed on probation for the next enrolled semester. If, at the end of that semester, the student has met the college's cumulative grade point average (2.0 GPA) and completion rate (67%) requirements, the student will be in good standing. Students who do not reach the college's cumulative grade point average and completion requirements, but have a semester GPA of at least 2.5 and course completion of 100% on probation for another semester of enrollment. Students who fail to meet cumulative or semester requirements for GPA and completion will be placed back on financial aid suspension.

TUITION AND FEES

Tuition Rates

The Board of Trustees for Minnesota State Colleges and Universities establishes tuition rates annually. Tuition rates are established on a per-credit basis for all credit course offerings and are subject to change. The Course Schedule lists tuition and fee rates for the term.

Senior Citizen Tuition Options

If you are a qualified senior citizen (over the age of 62) you may be eligible to attend classes at a reduced tuition rate. You must be a MN resident. Refer to the current Course Schedule for details. Registration is allowed on a space-available basis beginning second class session. Registration must happen in-person at the One Stop, Room 1300. Senior citizens who register before the first day of the semester must pay full tuition and fees.

Student Fees

Course Fees Selected courses have additional course fees which can include, but are not limited to, charges for such items as: tools, books, materials and supplies retained by the student, liability insurance (clinical experiences), or special testing fees, etc. Course fees are listed in the Course Schedule displayed on the College website. To determine if a course has additional course fees, select the course from the semester course schedule and place cursor on the course title and click the link to view the course details.

Fees Charged Per Credit MSCSA (Student Association) Fee

The Minnesota State College Student Association fee, assessed to all students, provides for support of the statewide student association by providing training and development of campus leaders, and lobbying of student interests with the legislative and executive branches of the State of Minnesota as well as at the national government level. The MSCSA Fee is 35¢ per credit for the 2019-2020 school year.

Parking/Safety/Facilities Fee

This fee at the College covers costs associated with parking, safety, and facilities. The fee must cover all costs associated with the parking operations of the College. Parking Prices can be found on the College website at saintpaul.edu/parking.

Students who do not use their Student ID card are charged a daily fee to use the parking facilities.

Student Life Fee

These funds are for the support and development of Student Life groups, activities and functions.

Technology Fee

A technology fee is charged as allowed by the Minnesota State. The technology fee is used for purchasing instructional equipment and materials such as computers and software, audio-visual equipment, library technology, and support staff.

Other Fees

Late Fee

There is a late fee of up to \$50.00 per semester fee charged to debtors who do not pay their account balance, in full, by the established deadlines. A hold will be placed on your account for any unpaid balance. This hold will prevent you from registering for classes.

Library Fine

Students who fail to return materials will be charged for all overdue library materials.

Non-sufficient Funds/Returned Check Fee

When checks are returned to the college, due to non-sufficient funds (NSF), account closure or stop payment a fee of \$24.00 is assessed for each check.

Transcript Fee

There is a \$5 charge for each academic transcript request. Allow three days for processing. An additional \$5 will be charged for next business day service.

SPC Card Replacement Fee

The SPC Card provides multiple campus functions and is used as a photo ID, a parking access card and door access card. There is a \$15 charge to replace a lost or stolen SPC Card.

The fee must be paid before the card is re-issued.

All fees are subject to change.

ACCUPLACER Re-Test fee

Students are granted two attempts at the ACCUPLACER each calendar year. The second attempt carries a fee of \$5. The fee must be paid before retaking the assessment.

Tuition Payment/Deferment Options

The full tuition and fees must be paid by the posted due date for the semester or classes will be deregistered. You may defer tuition and fees by any of the seven options below.

1. Online through your student account. Payment types accepted are Visa, MasterCard, Discover, or E-Check.
2. Make a payment at the Tuition Office during business hours. Payment types accepted are Master Card, Visa, Discover, cash, or check.
3. Mail your payment to the address below. (Please do not mail cash) Make sure to include your student ID number, name, and phone number. Mail your payment no later than five business days before tuition is due.

Saint Paul College Tuition Office
235 Marshall Avenue
Saint Paul, MN 55102
4. Drop your payment in the Tuition Office Drop Box located next to the tuition windows. Please include your student ID number, name, and phone number. Payments dropped after business hours will be processed the next business day.
5. Set up a payment plan through Nelnet Business Solutions. NBS is a third party tuition management company. For a fee they will set up a payment schedule and forward your payments to the Tuition Office. Allow at least one week prior to the tuition due date for processing.
6. Complete a Financial Aid (FA) application (FAFSA). Please allow two weeks for the Institutional Student Information Record (ISIR) to be received at the school. You are responsible for completing the full FA process.
7. Students who receive funding from scholarships, sponsoring agencies, or organizations will have their tuition deferred. Authorizations should be submitted using the Saint Paul College Authorization for Payment or a similar form that provides the same information. It is the student's responsibility to ensure that the Tuition Office receives the proper authorization from the third party one week before the tuition due date.

For students registering or adding classes after the tuition due date, the tuition is due within 24 hours of adding classes. Invoices are not mailed. Students must check their account balance online and pay any balance due by the posted due dates on the academic calendar. Students should also check their Saint Paul College email accounts for tuition payment deadline reminders and informational announcements.

For further details on different payment options visit: saintpaul.edu/admissions/tuition-and-fees-payment-options. Students will be responsible for any balances remaining after financial aid, third party, and Nelnet payments have been finalized.

Tuition Policy

You are responsible for dropping the courses you do not wish to take. Please check your eServices account each day during the add/drop period to ensure your schedule is what you intend to take. You are financially and academically responsible for any registered courses. Non-attendance is not a cancellation and students will be held responsible to pay any amount owed.

Non-Resident Tuition Status

The College considers resident and non-resident students the same for tuition rate purposes. Only MN residents are eligible for the Senior Citizen Rate.

Non-Payment of Tuition

Students who have not made payment or do not have a tuition deferment by the posted due date may lose their place in each registered class. Students who are not planning on attending should drop themselves from courses prior to the start of the semester. Students who have not deregistered are responsible for the unpaid balance. Refer to the current Course Schedule for details.

Tuition Refund Policy

Refunds for Total Withdrawal from College

If you withdraw from all courses, you may be eligible for a tuition refund according to the schedule below. You may submit the request online through your account or present an Add/Drop/Withdraw Form to One Stop by the noted due dates. Failure to attend class does not constitute withdrawal.

Withdrawal Period - Fall & Spring Semester Refund

Prior to the 1st day of the semester	100%
1st through 5th business day of the semester	100%
6th through 10th business day of the semester	75%
11th through 15th business day of the semester	50%
16th through 20th business day of the semester	25%
After the 20th business day of the semester	0%

Withdrawal Period - Summer/Other Semester Refund

At least 3 weeks but less than 10 weeks in length	
Prior to the 1st day of the semester	100%
1st through 5th business day of the semester	100%
6th through 10th business day of the semester	50%
After the 10th business day of the semester	0%

Refunds for Change of Credit Load

No tuition refund will be made, nor will fees be reduced, by withdrawing from only part of your credits after the 5th business day of the semester.

Refund Time Frame

Refunds for tuition payments made by cash or check will be made to the student's refund preference of direct deposit, check or BankMobile Vibe Account.. Credit card payments will be refunded to the same credit card that was used when the tuition was paid. A minimum of one week is required to process refunds paid by cash or credit card. A minimum of two weeks is required to process refunds for tuition and fees paid by check.

Waivers

The College may waive amounts due for the following reasons: employee benefit provided by bargaining agreement, death of a student, medical reasons, college error, employment related condition, significant documented personal circumstances, student leader stipends, course conditions, natural disasters or other situations beyond the control of the College. The College cannot waive the LeadMN student association fee. Contact the Tuition Office if you feel you are entitled to a waiver.

FINANCIAL AID

General Information

Financial aid is money that is available to help students finance the cost of an education. Financial aid comes in the form of grants (money that the student does not have to pay back), loans (money that the student must pay back) and college work-study (money the student earns through employment). Eligibility is determined from the results of the Free Application for Federal Student Aid (FAFSA).

As a student, you have the primary responsibility to pay for your education. Financial aid is intended to supplement the difference between the cost of education and the expected family contribution. Several programs are available to help you meet your educational expenses. The Financial Aid Office determines Saint Paul College financial aid eligibility after receiving the FAFSA results and after processing all required documents. The student must be admitted to a program/declare a major at Saint Paul College that leads toward a degree, diploma, or eligible certificate to be qualified to receive financial aid.

Financial Aid Definitions

- **FAFSA** - The FAFSA is the Free Application for Federal Student Aid, FAFSA. This is the application for all types of financial aid: grants, loans, or college work-study.
- **Cost of Attendance** - This is considered the cost of education at the College. It includes tuition, fees, a room and board allowance, books, supplies, a transportation allowance, and a personal expense allowance. It helps determine how much financial aid a student is able to receive during a semester of enrollment.
- **Expected Family Contribution** - An amount, determined by a formula called Federal Methodology, that indicates how much of the student and the student's family's resources should be available to help pay for school. The Expected Family Contribution (EFC) is used in determining the student's eligibility for federal and state financial aid. If a student has unusual expenses that may affect the student's ability to pay for school, the student should notify the Financial Aid Office.
- **Financial Need** - Financial need is the difference between the cost of attendance and the expected family contribution.
- **Full-Time Enrollment**: 12 credits or more per semester.
- **Three-Quarter-Time Enrollment**: 9-11 credits per semester.
- **Half-Time Enrollment**: 6-8 credits per semester.
- **Less Than Half-Time Enrollment**: 5 credits or fewer per semester.

Types of Financial Aid

Grants

Grants are gift aid, which the student does not have to pay back. Students who have completed a bachelor's degree, or the equivalent from another college, are not eligible for grants.

Federal Pell Grant

Students apply for the Federal Pell Grant by completing the FAFSA. Pell Grants vary from \$400 per year up to the federally legislated maximum. Pell Grant recipients must be enrolled in an eligible program and must maintain satisfactory progress in their coursework.

Federal Supplemental Education Opportunity Grant (SEOG)

This program is designed for students who have exceptional financial need. Funds are limited. Eligibility is determined by the Financial Aid Office with priority given to students who apply for Financial Aid early.

Minnesota State Grant

A grant for Minnesota residents who are attending an accredited post-secondary institution, the award process is similar to the Pell Grant. Students apply by completing the FAFSA.

Minnesota Postsecondary Child Care Grant

This grant is for students who are Minnesota residents, have children ages 12 and under (14 and under, if disabled), have financial need, and have child care expenses. Recipients must not be receiving Minnesota Family Investment Program (MFIP) assistance. Students who have received an award letter can request an application from the Financial Aid Office or online.

Work-Study Programs

These programs employ students on campus. Pay is established by the College. These programs provide work for up to 20 hours per week. Total work-study earnings are not to exceed the cost of attendance. Work study positions available on campus include tutors, office assistants, and lab assistants.

Loans

Loans are financial aid that must be paid back. You must complete online entrance loan counseling and a Master Promissory Note through Saint Paul College in order to apply for a loan.

Federal Direct Loans

Students can also receive help to meet their educational expenses by borrowing money from Federal Student Aid. Subsidized and Unsubsidized loans are available based on eligibility. Dependent first year students can borrow up to \$5,500 per academic year. Upon completion of 30 credits toward program requirements, eligibility increases to \$6,500 per academic year. Independent students are eligible for additional unsubsidized loans. All loans must have two disbursements. Loans accepted for only one semester will have a disbursement at the start of the semester and a second disbursement half-way through the semester.

PLUS Loan Program

The Federal Parent Loans for Undergraduate Students (PLUS) Loan Program for undergraduate students can be used by parents of dependent students who are in need of additional funds. The program allows parents to borrow up to the cost of attendance minus other aid. Parents must successfully pass a credit check to be eligible for a PLUS loan.

Private Loans

You are strongly encouraged to pursue the availability of free or lower-cost financial aid with the College's financial aid office; however, private educational loans can bridge the gap between government programs and the cost of attendance. Eligibility is typically based on your credit score. You can only apply for these loans by contacting banks or other lenders.

Other Sources of Financial Assistance

Several government and private agencies provide financial assistance to eligible students. Contact the local office of any of the following agencies for consideration. The agency determines who is eligible for assistance.

- Division of Rehabilitation Services (DRS/DVR):
www.deed.state.mn.us/rehab
- Minnesota Indian Scholarship Program:
www.ohe.state.mn.us
- Veteran Benefits (VA):
www.vba.va.gov/VBA
- Services for the Blind (SSB):
www.mnssb.org

Private Scholarships - check with your high school counselor or the public library, and the following websites:

- www.fastweb.com
- www.finaid.org
- www.fastaid.com
- www.college-scholarships.com

How to Apply for Financial Aid

1. Apply for admission to the College. Students must declare a major and be enrolled in a program leading towards a degree, diploma or eligible certificates to be qualified for financial aid. Awards vary based on your enrollment level (full-time, part-time). Financial aid will be based on the number of enrolled credits by the drop/add deadline.
2. Fill out the Free Application for Federal Student Aid (FAFSA). You must apply electronically through the Federal Department of Education website at www.fafsa.gov. During the application, enter the Saint Paul College school code, 005533. The Financial Aid Office will receive an electronic copy of the results within two weeks.
3. If you have attended any post-secondary schools prior to Saint Paul College and want to be considered for the Minnesota State Grant, submit academic transcripts to the Financial Aid Office from all previously attended schools.

4. After the Financial Aid Office receives the FAFSA results from Student Federal Aid, your application will be reviewed. Quickly respond to any and all requests for additional information. When your file is complete, financial aid eligibility will be calculated and you will be notified by email that an award letter has been created on your College e-services account.
5. Carefully read your award letter and follow the instructions for receiving awards. All loans and the Minnesota Child Care grant require additional application requirements.

Students Selected for Financial Aid Verification

The College verifies Free Application for Federal Student Aid (FAFSA) information of students selected by the Federal Student Aid or selected by the College. Students selected for verification will be notified by email that the Aid Application Status Letter, explaining the required documentation to complete the verification process, is available on their e-services account. The Aid Application Status Letter will request specific information and/or documents required for verification. Self-reported information including household size or number attending college may be requested or documents including proof of citizenship or child support paid may be needed. The documentation requested will depend on the verification group the student is placed in, as chosen by Federal Student Aid or the College.

Students should submit all required documentation within 30 days of the request. The financial aid process will not continue until the required documentation is received. Not submitting the requested documentation in a timely manner may result in loss of eligibility for the current academic year.

Once all required documentation has been received, students should allow a minimum of 14 business days for the verification process to be completed. If the FAFSA data matches the verification information, the Financial Aid process will continue toward a complete and accurate file at which time the student Award Letter can be viewed on-line at saintpaul.edu under the student's eServices account. Any FAFSA discrepancies found as a result of the verification process will be corrected by the Financial Aid Office and electronically submitted to the central processor. Upon receiving a corrected FAFSA report from the central processor, an Award Letter will be available to the student. Any cases of suspected fraud of misreported information or altered documentation to fraudulently obtain federal funds will be discussed with the College administration and referred to the Office of Inspector General of the Department of Education via Minnesota State.

Applying Financial Aid to Your Account

Financial Aid and other awards start applying to your student account during the third week of each semester. If you are using financial aid to pay your tuition and fees, you will have a balance on your account until the third week of classes. Students interested in charging books and supplies to their student accounts can do this through their Financial Aid award notification process. Any charges made through book charging will be added to your account and then paid when aid is applied.

Any remaining excess funds will be sent to the student through BankMobile. You will receive a letter in a green envelope from BankMobile shortly after registering for your first class. After

you receive the letter, you must choose how you want to receive any excess funds. You can set up a direct deposit to a current bank account, request a debit card (known as the Saint Paul College Card) from BankMobile, or have a check mailed to you. For more information on disbursement, go to Saint Paul College Card: Disbursement Options.

After the first disbursement of the semester, aid applies weekly to student accounts on Wednesdays. First-time loan borrowers must wait 30 days until the first disbursement of their loans. All loans must have at least two disbursements. Semester-only loans will be disbursed at the beginning of the semester and at the half-way point of the semester.

Financial Aid Policies & Procedures

Withdrawals

If you withdraw from the College before the add/drop date for a semester, you will not receive financial aid funds because there will be no class registration. If you withdraw from attendance at the College for any reason after the add/drop date for the semester, you will be placed on financial aid probation the following academic semester.

Students who receive financial aid and withdraw from all classes are subject to a Federal Return of Title IV Funds policy. The policy states that if you withdraw up through 60% of the semester, a proportional amount of financial aid either received or that was applied to your student account must be refunded to the Federal government.

Any institution refund calculated within the first four weeks of school semester will be applied to the student's account to reduce the student's share of the Return of Title IV Funds. Funds returned to the federal government are used to reduce the federal program amount from which funds were disbursed. Funds are returned in the following order:

- Unsubsidized Federal Direct Loan
- Subsidized Federal Direct Loan
- Federal PLUS Loan
- Federal Pell Grant
- Federal SEOG Grant

Other assistance under Title IV for which a Return of Funds is required

After the institution's share of any required refund to Title IV programs has been refunded, a proportional share of any remaining institutional refund (not to exceed the amount of the State grant payment the student initially received for the semester), must be returned to the State Grant Program.

Consortium Agreements for Financial Aid

If you are taking classes at another college which are required for your program at the College, you must complete a consortium agreement if you would like those courses considered for financial aid eligibility. The Consortium Agreement form is available online on the Financial Aid Forms page and also in One Stop, and must be completed with an attached registration form from the host institution and submitted to One Stop by the add/drop deadline. If a consortium agreement is not submitted, financial aid calculations cannot consider courses taken at the host school, as you cannot receive financial aid at two different schools during the same semester of enrollment.

Tuition & Fee Deferments

Tuition and fees will be deferred provided the following has been met by the posted tuition deadline for the semester:

1. Student has received an Award Letter with financial aid eligibility equal to or greater than the tuition/fee charge. (Loan eligibility requires a submitted Promissory Note).
2. An electronic Institutional Student Information Record (ISIR) is received resulting from submission of a FAFSA.
3. Any tuition/fee balance not covered by Financial Aid is the student's payment responsibility.

Financial Aid Book Charging Process

You may charge the cost of your books prior to financial aid being disbursed if you meet all the following criteria:

1. You are registered for current semester classes.
2. You have received your Financial Aid Award Letter and have completed the loan acceptance, if you will be using loan funds to pay for books and supplies.
3. The total financial aid you will be receiving, at your registered credit level, exceeds your current account balance.
4. You have completed the one-time Miscellaneous Charge Authorization in your Financial Aid Award Notification in eServices.
5. You have activated your Saint Paul College email account.

Financial Aid Book Charging allows students to charge books and supplies at the Saint Paul College Bookstore and is administered by the Tuition Office.

Special Circumstances/Income Review

Federal laws governing financial aid allow the College Financial Aid Office to recalculate financial need in cases of special circumstances not taken into consideration by the Free Application of Federal Student Aid (FAFSA). To ensure fairness and compliance with federal regulations, there are limits to which circumstances can be considered. Special circumstances are considered on a case by case basis.

For more detailed information on types of special circumstances and requirements for submitting a "Special Circumstances Appeal Form" go to saintpaul.edu/financialaidforms.

Dependency Override Appeal

Federal Student Aid determines a student's status as dependent or independent by the answers the student provides on the thirteen questions listed in Step 3 of the Free Application for Federal Student Aid (FAFSA). Students are classified as dependent or independent because federal student aid programs are based on the principle that students (and their parents or spouse) are considered the primary source of support for postsecondary education. The Dependency Override process is used to address on a case-by-case basis a student who claims to be independent but does not meet the federal criteria. The student must demonstrate unique and extenuating circumstance.

For more detailed information on types of extenuating

circumstances given consideration and requirements for submitting a "Dependency Override Appeal: Student Information/Recourse Statement" form go to saintpaul.edu/financialaidforms.

Audited & Credit by Exam Courses

Audited or Credit by Exam Courses are not eligible for Financial Aid.

Consortium Credits

Credits for which financial aid is disbursed under a consortium agreement will be recorded as consortium agreement credits and will be included in the calculation of Satisfactory Academic Progress for financial aid.

Developmental Education Courses & English for Academic Purposes (EAPP) Courses

Developmental Education courses and English for Academic Purposes (EAPP) courses will be included in the cumulative GPA and completion rate. English for Academic Purposes (EAPP) courses and up to 30 credits of Developmental Education coursework will be excluded from the 150% maximum time frame calculation.

Repeated Courses

Courses may be repeated for financial aid eligibility for "F," "W," "FN" or "FW" grades or if program requirements require a higher grade. The cumulative GPA will use the highest grade achieved. To request the opportunity to repeat a course for the third time, students should meet with their Pathway Advisor. Courses repeated a third time require registration permission. The cumulative completion rate includes all repeated courses.

Satisfactory Academic Progress for Financial Aid

Transfer Credits

Credits taken at previous schools accepted for current program requirements will be included in the 150% maximum timeframe.

Withdrawals

All coursework designated with a withdrawal are calculated in the cumulative completion rate and maximum timeframe.

Tax Benefits for Education

Tax credits, deductions and savings plans can help taxpayers with their expenses for higher education.

- A tax credit reduces the amount of income tax you may have to pay. Education credits include the American Opportunity Credit and the Lifetime Learning Credit.
- 1098-T Tuition statements are issued in January.
- Please go to the following website for additional information:
www.minnstate.edu/system/finance/taxinformation
- A deduction reduces the amount of your income that is subject to tax, thus generally reducing the amount of tax you may have to pay.

- Certain savings plans allow the accumulated interest to grow tax-free until money is taken out (known as a distribution), or allow the distribution to be tax-free, or both.
- An exclusion from income means that you won't have to pay income tax on the benefit you're receiving, but you also won't be able to use that same tax-free benefit for a deduction or credit.

for students transferring with at least 12 college-level credits from another Minnesota State Colleges and Universities institution or the University of Minnesota.

Total Credits Required for the AA Degree

Minnesota Transfer Curriculum (MnTC): 40 credits
 Additional MnTC and/or
 pre-major elective courses: 20 credits
Total Requirements: 60 credits

EDUCATIONAL PROGRAMS

Liberal Arts and Sciences Associate of Arts (AA) Degree

Program Overview

The Associate of Arts (AA) degree is awarded for successful completion of 60 semester credits in liberal arts and sciences and is designed to constitute the first two years of a baccalaureate degree. It is also intended primarily for students who plan to transfer to another college or university to complete a bachelor's degree. No specific major is listed in conjunction with the degree; however, students may choose electives in a particular field of study in preparation for a planned major or professional emphasis at a four year college or university. An AA degree must include the entire Minnesota Transfer Curriculum (MnTC) 40 semester credits which, pursuant of Minnesota statute, must transfer to any institution in the Minnesota State Colleges and University system or to the University of Minnesota. Students are to develop an educational plan with a Pathway Advisor to verify degree requirements are fulfilled, as requirements may vary depending upon the major and transfer college.

The AA degree can be completed through a variety of course delivery methods including face to face, hybrid and/or online. The Science, Technology, Engineering and Math (STEM), and Liberal and Fine Arts departments offer online classes to satisfy the MnTC requirements. A student may choose to complete the entire AA degree online.

Program Outcomes:

1. Knowledge of the important concepts and principles of the natural sciences, mathematics, history, social and behavioral sciences, arts, and humanities
2. Skills necessary for life roles, including skills in thinking, communication and methods of inquiry and applications of knowledge
3. Critical examination of, and an appreciation for, diverse people, cultures and life roles

General Requirements

- At least 60 earned college-level credits (40 MnTC credits and 20 additional MnTC and/or pre-major elective credits)
- A grade of "C" or better in ENGL 1711
- Cumulative GPA of 2.0
- MnTC GPA of 2.0
- Meet Saint Paul College residency requirement of 20 credits. This requirement shall be reduced to 12 credits

MnTC Distribution Requirements for the AA Degree

The minimum Minnesota Transfer Curriculum (MnTC) distribution requirements for the AA degree are listed below. (Refer to the MnTC Course List)

Course	Cr
Minnesota Transfer Curriculum (MnTC) Goals 1-10	40
Goal 1: Communication ENGL 1711 Composition 1 – 4 cr ENGL 1712 Composition 2 – 2 cr COMM 17XX One eligible course – 3 cr	9
Goal 2: Critical Thinking Fulfilled when all the goal areas are completed (40 credits)	
Goal 3: Natural Sciences Minimum of two courses from two different disciplines, one of which must be a lab course.	7
Goal 4: Mathematical/Logical Reasoning Minimum of one course. Courses must be numbered between 1700-1799 or 2700-2799	3
Goal 5: History, Social Sciences, and Behavioral Sciences Minimum of three courses from two different disciplines.	9
Goal 6: Humanities and Fine Arts Minimum of three courses from two different disciplines.	9
Goal 7: Human Diversity Minimum of one eligible course	1-4
Goal 8: Global Perspective Minimum of one eligible course	1-4
Goal 9: Ethic and Civil Responsibility Minimum of one eligible course.	1-4
Goal 10: People and the Environment Minimum of one eligible course.	1-4

Note: Refer to the MnTC Course List. Some courses may be applied to more than one goal area. If you meet the MnTC goal requirements with fewer than 40 semester credits, select additional MnTC courses to complete the minimum requirement of 40 semester credits.

Associate of Fine Arts (AFA)

The Associate in Fine Arts (AFA) is designed for students who plan to transfer to a four-year college to pursue a Bachelor in Fine Arts Degree. It provides an exposure to the general education courses required by four-year Bachelor of Fine Arts Programs.

AFA Degree Programs

- Associate of Fine Arts -Music Degree

General Requirements for the AFA Degree:

- 60 earned college-level credits (a minimum of 30 credits from MnTC courses)
- Cumulative GPA of 2.0
- Meet Saint Paul College residency requirement of 20 credits. This requirement shall be reduced to 12 credits for students transferring with at least 12 college-level credits from another Minnesota State Colleges and Universities institution or the University of Minnesota. For specific course requirements, see the individual program descriptions, located in One Stop, or speak with your Pathway Advisor.

Associate of Science (AS) Degree

The Associate of Science (AS) degree is awarded for successful completion of a program of 60 semester credits in a designated field or area which transfers to a baccalaureate major in a related scientific or technical field. The AS degree provides a balance of liberal arts education and career-oriented classes. The AS degree may prepare students for direct employment; however, articulation agreements must exist between the institution awarding the Associate of Science degree and an institution awarding a related baccalaureate degree. An Associate of Science degree shall include a minimum of 30 semester credits in general education as described in the MnTC distribution requirements for the AS degree.

Transfer Note: While the AS degree has more limited transferability than the AA degree, specific transfer articulation agreements exist with designated four-year colleges and universities for each AS degree. Minnesota Transfer Curriculum courses within the AS degree transfer to institutions in the Minnesota State Colleges and Universities system and other colleges. Please see a Pathway Advisor and refer to the Transfer Articulation Agreements Table for specific information.

AS Degree Programs

- Biology Transfer Pathway
- Business Transfer Pathway
- Chemistry Transfer Pathway
- Child Development Careers
- Child Development Careers ASL
- Computer Graphics and Visualization
- Computer Science Transfer Pathway
- Data Science
- Engineering Broad Field
- Finance

- Health Sciences Broad Field
- Management Information Systems
- Public Health
- Science Technician

General Requirements for the AS Degree:

- 60 earned college-level credits (a minimum of 30 credits from MnTC courses)
- Cumulative GPA of 2.0
- Meet Saint Paul College residency requirement of 20 credits. This requirement shall be reduced to 12 credits for students transferring with at least 12 college-level credits from another Minnesota State Colleges and Universities institution or the University of Minnesota. For specific course requirements, see the individual program descriptions, located in One Stop, or speak with your Pathway Advisor.

MnTC Distribution Requirements for the AS Degree

The minimum Minnesota Transfer Curriculum (MnTC) distribution requirements for the AS degree are listed below. Credit and course requirements are specific for each program. Refer to the curriculum requirements listed in the Programs of Study for each AS degree program.

Note: Specific course recommendations or requirements for some AS degree programs may apply.

AS Degree General Education Requirements	Cr
Refer to the Minnesota Transfer Curriculum Course List for each Goal Area	
Goal 1: Communication ENGL 1711 Composition 1 – 4 cr COMM 17XX (Goal 1 only) – 3 cr	7
Goal 3 or Goal 4 Goal 3: Natural Sciences Goal 4: Mathematical/Logical Reasoning	3
Goal 5: History, Social Sciences and Behavioral Sciences	3
Goal 6: Humanities and Fine Arts	3
Goals 1–10 of the Minnesota Transfer Curriculum Select a minimum of 14 additional credits Students must select courses from at least six (6) Goal Areas of the Minnesota Transfer Curriculum.	14
Total General Education Requirements	30

Associate of Applied Science (AAS) Degree

The Associate of Applied Science degree (AAS) is awarded for successful completion of a program of 60–72 semester credits and is intended for students who desire immediate employment upon graduation. At Saint Paul College, the AAS program shall include a minimum of 16 semester credits of liberal arts and sciences courses as described in the MnTC distribution requirements for the AAS degree.

Transfer Note: The AAS degree is not intended to transfer to an upper-division college; however, some articulation agreements exist with designated four-year colleges and

universities for several of the AAS degree programs. Minnesota Transfer Curriculum (MnTC) courses within the AAS degree transfer to institutions in the Minnesota State Colleges and Universities system and other colleges. Please see a Pathway Advisor for specific information and refer to the Transfer Articulation Agreements Table.

AAS Programs

- Accounting
- Automotive Service Technician
- Child Development Careers
- Clinical Sports Massage
- Computer Network Engineering
- Computer Programming
- Cosmetology
- Culinary Arts
- CyberSecurity
- Esthetician (Advanced Practice)
- Esthetician (Spa)
- Geographic Information Science
- Global Trade Specialist
- Health Information Technology
- Healthcare Informatics
- Hospitality Management
- Human Resources
- Individualized Studies
- Marketing
- Medical Laboratory Technician
- Medical Office Professional
- Office Management Professional
- Patient Care Technician
- Pharmacy Technician
- Project Management
- Respiratory Therapist
- Sheet Metal-HVAC Ducts and Fittings
- Sign Language Interpreter/Transliterater
- Sport and Exercise Sciences
- Supply Chain Logistics
- Surgical Technology
- Visualization Technology

General Requirements for the AAS Degree:

- 60–72 earned college-level credits (a minimum of 16 credits from MnTC courses)
- Cumulative GPA of 2.0 or higher
- Meet Saint Paul College residency requirement of 20 credits. This requirement shall be reduced to 12 credits for students transferring with at least 12 college-level credits from another Minnesota State Colleges and Universities institution or the University of Minnesota. For specific course requirements, see the individual program descriptions, located in One Stop, or speak with your Pathway Advisor.

MnTC Distribution Requirements for the AAS Degree

The minimum Minnesota Transfer Curriculum (MnTC) distribution requirements for the AAS degree are listed below. Credit and course requirements are specific for each program. Refer to the curriculum requirements listed in the Programs of Study section for each AAS degree program.

AAS Degree General Education Requirements	Cr
Refer to the Minnesota Transfer Curriculum Course List for each Goal Area	
Goal 1: Communication ENGL 1711 Composition 1 – 4 cr COMM 17XX (Goal 1 only) – 3 cr	7
Goal 3 or Goal 4 Goal 3: Natural Sciences OR Goal 4: Mathematical/Logical Reasoning	3
Goal 5: History, Social Sciences and Behavioral Sciences	3
Goal 6: Humanities and Fine Arts	3
Total General Education Requirements	16

Diploma Programs

Diplomas are awarded for successful completion of 30–72 semester college-level credits and are intended for students who desire entry-level employment skills or career advancement. Students in diploma programs are required to complete technical courses as well as general education courses. One third of the credits required for a diploma must be earned at the College.

Certificate Programs

Certificates are awarded for successful completion of 9–30 semester college-level credits. Certificates are awarded for successful completion of a program intended to provide students with entry-level employment skills or to enhance a student's technical skills. One third of the credits required for a certificate must be earned at the College.

Developmental Coursework

Developmental coursework has assisted thousands of students in getting started in College programs. The goal of developmental coursework is for students to acquire the necessary knowledge and skills that will help them succeed in programs. Developmental courses are not considered college-level credit and will not apply towards any certificate, diploma, or degree completion requirements.

English for Academic Purposes (EAP)

The purpose of English for Academic Purposes (EAP) coursework is to assist limited-English speakers from different ethnic and cultural backgrounds to learn English and increase their chances of success at Saint Paul College. These classes are tailored to meet these unique needs.

Internships

Some major program areas require an internship. For other areas, an internship is optional. When students are ready to complete this phase of their training, they should consult with their faculty advisor to coordinate the internship.

While completing the internship, the student remains registered at Saint Paul College. Students are not excused from tuition payment and must continue to meet course requirements for all courses in which they are enrolled.

Saint Paul Joint Apprenticeship

Saint Paul College has worked with the building trades for many years. In cooperation with Advisory and Joint Apprenticeship committees, Saint Paul College works to give trade apprentices the most up-to-date education and training available in the United States. Most applicants are accepted into an apprenticeship program by either a) working in the occupation, b) being referred by an employer, or c) having completed a pre-apprenticeship training program. To enroll in one of the trade programs, please contact One Stop for the next available opening date and application. Entrance exams, and in some cases interviews, are required. To enroll in a program without a program completion requirement, students must contact that apprenticeship coordinator. Students may obtain their name or number by calling the Career and Technical Division, 651.846.1609.

MINNESOTA TRANSFER CURRICULUM

The Saint Paul College mission endorses the centrality of general education in its programming and its commitment to offer breadth, as well as depth, of study in its curriculum. The Minnesota Transfer Curriculum (MnTC) is a coherent requirement of Saint Paul College programs and is clearly identifiable as an integral part of the curriculum. The College is committed to, and strives toward, outcomes that impart common knowledge, intellectual concepts and attitudes every person ought to possess.

Minnesota Transfer Curriculum Goals

The Minnesota State Colleges and Universities system has developed a common general education curriculum called the Minnesota Transfer Curriculum (MnTC). Completion of this defined transfer curriculum at one institution enables a student to receive credit for all lower division general education upon admission to any other Minnesota public institution.

The MnTC is intended to achieve the following ten goals:

1. Written and Oral Communication

To develop writers and speakers who use the English language effectively and who read, write, speak and listen critically. As a base, all students should complete introductory communication requirements early in their collegiate studies. Writing competency is an ongoing process to be reinforced through writing-intensive courses and writing across the curriculum. Speaking and listening skills need reinforcement through multiple opportunities for interpersonal communication, public speaking and discussion.

- a. understand/demonstrate the writing and speaking processes through invention, organization, drafting, revision, editing and presentation.
- b. participate effectively in groups with emphasis on listening, critical and reflective thinking, and responding.
- c. locate, evaluate, and synthesize in a responsible manner material from diverse sources and points of view.
- d. select appropriate communication choices for specific audiences.
- e. construct logical and coherent arguments.
- f. use authority, point-of-view, and individual voice and style in their writing and speaking.
- g. employ syntax and usage appropriate to academic disciplines and the professional world.

2. Critical Thinking

To develop thinkers who are able to unify factual, creative, rational and value-sensitive modes of thought. Critical thinking will be taught and used throughout the general education curriculum in order to develop students' awareness of their own thinking and problem-solving procedures. To integrate new skills into their customary ways of thinking, students must be actively engaged in practicing thinking skills and applying them to open-ended problems.

3. Natural Sciences

To improve students' understanding of natural science principles and of the methods of scientific inquiry, i.e., the ways in which scientists investigate natural science phenomena. As a basis for lifelong learning, students need to know the vocabulary of science and to realize that, while a set of principles has been developed through the work of previous scientists, ongoing scientific inquiry and new knowledge will bring changes in some of the ways scientists view the world. By studying the problems that engage today's scientists, students learn to appreciate the importance of science in their lives and to understand the value of a scientific perspective. Students should be encouraged to study both the biological and physical sciences.

- a. demonstrate understanding of scientific theories
- b. formulate and test hypotheses by performing laboratory, simulation, or field experiments in at least two of the natural science disciplines. One of these experimental components should develop, in greater depth, students, laboratory experience in the collection of data, its statistical and graphical analysis, and an appreciation of its sources of error and uncertainty.
- c. communicate their experimental findings, analyses, and interpretations both orally and in writing.
- d. evaluate societal issues from a natural science perspective, ask questions about the evidence presented, and make informed judgments about science-related topics and policies.

4. Mathematical/Logical Reasoning

To increase students' knowledge about mathematical and logical modes of thinking. This will enable students to appreciate the breadth of applications of mathematics, evaluate arguments and detect fallacious reasoning. Students will learn to apply mathematics, logic and/or statistics to help them make decisions in their lives and careers. Minnesota's public higher education systems have agreed that developmental mathematics includes the first three years of a high school mathematics sequence, through intermediate algebra.

- a. illustrate historical and contemporary applications of mathematical/logical systems.
- b. clearly express mathematical/logical ideas in writing.
- c. explain what constitutes a valid mathematical/logical argument (proof).
- d. apply higher-order problem-solving and/or modeling strategies.

5. History, Social and Behavioral Sciences

To increase students' knowledge of how historians and social and behavioral scientists discover, describe and explain the behaviors and interactions among individuals, groups, institutions, events and ideas. Such knowledge will better equip students to understand themselves and the roles they play in addressing the issues facing humanity.

- a. employ the methods and data that historians and social and behavioral scientists use to investigate the human condition.
- b. examine social institutions and processes across a range of historical periods and cultures.
- c. use and critique alternative explanatory systems or theories.
- d. develop and communicate alternative explanations or solutions for contemporary social issues.

6. Humanities and Fine Arts

To expand students' knowledge of the human condition and human cultures, especially in relation to behavior, ideas and values expressed in works of human imagination and thought. Through study in disciplines such as literature, philosophy and the fine arts, students will engage in critical analysis, form aesthetic judgments and develop an appreciation of the arts and humanities as fundamental to the health and survival of any society. Students should have experiences in both the arts and humanities.

- a. demonstrate awareness of the scope and variety of works in the arts and humanities.
- b. understand those works as expressions of individual and human values within an historical and social context.
- c. respond critically to works in the arts and humanities.
- d. engage in the creative process or interpretive performance.

- e. articulate an informed personal reaction to works in the arts and humanities.

7. Human Diversity

To increase students' understanding of individual and group differences (e.g., race, gender, class) and their knowledge of the traditions and values of various groups in the United States. Students should be able to evaluate the United States' historical and contemporary responses to group differences.

- a. understand the development of and the changing meanings of group identities in the United States, history and culture.
- b. demonstrate an awareness of the individual and institutional dynamics of unequal power relations between groups in contemporary society.
- c. analyze their own attitudes, behaviors, concepts and beliefs regarding diversity, racism, and bigotry.
- d. describe and discuss the experience and contributions (political, social, economic, etc.) of the many groups that shape American society and culture, in particular those groups that have suffered discrimination and exclusion.
- e. demonstrate communication skills necessary for living and working effectively in a society with great population diversity.

8. Global Perspective

To increase students' understanding of the growing interdependence of nations and peoples and develop their ability to apply a comparative perspective to cross-cultural social, economic and political experiences.

- a. describe and analyze political, economic, and cultural elements which influence relations of states and societies in their historical and contemporary dimensions.
- b. demonstrate knowledge of cultural, social, religious and linguistic differences.
- c. analyze specific international problems, illustrating the cultural, economic, and political differences that affect their solution.
- d. understand the role of a world citizen and the responsibility world citizens share for their common global future.

9. Ethical and Civic Responsibility

To develop students' capacity to identify, discuss and reflect upon the ethical dimensions of political, social and personal life and to understand the ways in which they can exercise responsible and productive citizenship. While there are diverse views of social justice or the common good in a pluralistic society, students should learn that responsible citizenship requires them to develop skills to understand their own and others' positions, be part of the free exchange of ideas and function as public-minded citizens.

- a. examine, articulate, and apply their own ethical views.

- b. understand and apply core concepts (e.g. politics, rights and obligations, justice, liberty) to specific issues.
- c. analyze and reflect on the ethical dimensions of legal, social, and scientific issues.
- d. recognize the diversity of political motivations and interests of others.
- e. identify ways to exercise the rights and responsibilities of citizenship.

10. People and the Environment

To improve students' understanding of today's complex environmental challenges. Students will examine the inter-relatedness of human society and the natural environment. Knowledge of both bio-physical principles and socio-cultural systems is the foundation for integrative and critical thinking about environmental issues.

- a. explain the basic structure and function of various natural ecosystems and of human adaptive strategies within those systems.
- b. discern patterns and interrelationships of bio-physical and socio-cultural systems.
- c. describe the basic institutional arrangements (social, legal, political, economic, religious) that are evolving to deal with environmental and natural resource challenges.
- d. evaluate critically environmental and natural resource issues in light of understandings about interrelationships, ecosystems, and institutions.
- e. propose and assess alternative solutions to environmental problems.
- f. articulate and defend the actions they would take on various environmental issues.

Minnesota Transfer Curriculum (MnTC) Course List

To earn the full Minnesota Transfer Curriculum, all ten goal areas listed below must be completed. A total of at least 40 semester credits must be earned. Courses designated with a superscript (e.g., BIOL 1710¹⁰) satisfy more than one goal area; however, credits are counted only once toward the 40-credit minimum requirement. A (p) indicates a prerequisite is required for that course. Completion of the MnTC meets the lower division general education requirements at Minnesota State Colleges and Universities and the University of Minnesota. Contact the Pathway Advisor for more information.

To follow the Associate of Science or Associate of Applied Science requirements for general education courses, choose from the MnTC courses in the next column, according to the distribution requirements for your degree. The Associate of Science degree requires 30 MnTC credits; the Associate of Applied Science degree requires 16 MnTC credits.

For any additions or changes in the MnTC Course List, contact a College Pathway Advisor in Advising & Counseling.

MnTC Goal 1: Communication			Credits
ENGL	1711	Composition 1	4
ENGL	1712	Composition 2 (p)	2
ENGL	1730	Introduction to Technical Writing	3
ENGL	2790	Special Topics in English	1-6
COMM	1710 ⁸	Fundamentals of Public Speaking	3
COMM	1720 ⁷	Interpersonal Communication	3
COMM	1730 ⁸	Intercultural Communication	3
COMM	1750 ⁹	Small Group Communication	3
COMM	1770 ⁷	Family Communication	3
COMM	1780 ⁷	Gender Communication	3
COMM	1790	Special Topics in Communications	1-6

*Course contains lab (p) = Indicates prerequisite required for course

MnTC Goal 2: Critical Thinking		Credits
Fulfilled when all 10 Goal Areas of MnTC are completed		40

*Course contains lab (p) = Indicates prerequisite required for course

MnTC Goal 3: Natural Sciences			Credits
BIOC	1730*	Biochemical Laboratory Exploration	4
BIOC	1790	Special Topics in Biochemistry	1-6
BIOC	2700*	Biochemistry (p)	4
BIOC	2790	Biochemistry Internship/ Research Project	1-4
BIOL	1725 ^{10*}	Environmental Science	4
BIOL	1730*	Human Body Systems	3
BIOL	1735*	Understanding Biology	4
BIOL	1740*	General Biology: The Living Cell	5
BIOL	1745 ^{10*}	General Biology: The Living World (p)	5
BIOL	1760	Nutrition	3
BIOL	1782*	Introduction to Forensic Science	4
BIOL	1785 ⁹	Biology of Women	3
BIOL	1790	Special Topics in Biology	1-6
BIOL	2721*	Human Anatomy and Physiology 1 (p)	4
BIOL	2722*	Human Anatomy and Physiology 2 (p)	4
BIOL	2750*	General Microbiology (p)	4
BIOL	2775	Genetics (p)	4
BIOL	2760	Cell and Molecular Biology (p)	5
BIOL	2770	Biology Internship	1-4
CHEM	1700*	Chemistry Concepts	4
CHEM	1711*	Principles of Chemistry 1 (p)	4
CHEM	1712*	Principles of Chemistry 2 (p)	4

MnTC Goal 3: **Natural Sciences** *continued*

CHEM 2700*	Organic Chemistry Survey (p)	4
CHEM 2720*	Organic Chemistry 1 (p)	5
CHEM 2721*	Organic Chemistry 2 (p)	5
CHEM 2730*	Instrumental Analysis (p)	4
CHEM 2790	Science Technician Laboratory Research Project	1-4
CHEM 2791	Cleanroom Lab Research Project	1-4
CHEM 2795	Special Topics in Chemistry	1-6
NSCI 1710 ^{10*}	Earth Science	4
NSCI 1721 ^{10*}	Introduction to Geology	4
NSCI 1730 ¹⁰	Introduction to Oceanography	3
NSCI 1740 ¹⁰	Introduction to Meteorology	3
NSCI 1750 ¹⁰	Natural Disasters	3
NSCI 1770 ¹⁰	Introduction to Energy and the Environment	3
NSCI 1780 ⁹	Contemporary Issues in Science	3
NSCI 1782 ¹⁰	Minnesota Geology	3
NSCI 1790	Special Topics in Natural Science	3
NSCI 2770	Natural Sciences Internship	1-4
PHYS 1720*	Principles of Physics 1 (p)	4
PHYS 1722*	Principles of Physics 2 (p)	4
PHYS 1760 ¹⁰	Descriptive Astronomy (no lab)	3
PHYS 2700*	General Physics 1 (with Calculus) (p)	5
PHYS 2710*	General Physics 2 (with Calculus) (p)	5
PHYS 2760 ^{10*}	Introductory Astronomy (with lab)	4
PHYS 2790	Special Topics in Physics	1-6

*Course contains lab (p) = Indicates prerequisite required for course

MnTC Goal 4: Mathematical/Logical Reasoning Credits

MATH 1710	Liberal Arts Mathematics	3
MATH 1730	College Algebra	3
MATH 1740	Introduction to Statistics	4
MATH 1750	Trigonometry (p)	3
MATH 1762	Pre-Calculus (p)	5
MATH 1790	Special Topics in Mathematics	1-6
MATH 2100	Intermediate Statistics (p)	4
MATH 2749	Calculus 1 (p)	4
MATH 2750	Calculus 2 (p)	4
MATH 2753	Multivariable Calculus (p)	4
MATH 2760	Differential Equations and Linear Algebra (p)	4
PHIL 1710	Logic	3

*Course contains lab (p) = Indicates prerequisite required for course

MnTC Goal 5: History, Social Sciences, and Behavioral Sciences Credits

ANTH 1710 ⁷	Introduction to Cultural Anthropology	4
ANTH 1720 ¹⁰	Introduction to Physical Anthropology	4
ANTH 1730 ⁸	Gender and Culture in Global Perspectives	3
ANTH 1790	Special Topics in Anthropology	1-6
COMM 1740 ⁹	Mass Media & Communications	3
ECON 1710	Introduction to the American Economy	3
ECON 1720 ⁸	Macroeconomics	3
ECON 1730 ⁸	Microeconomics	3
ECON 1790	Special Topics in Economics	1-6
GEOG 1700 ¹⁰	Physical Geography	3
GEOG 1720 ⁸	Human / Cultural Geography	3
GEOG 1740 ⁸	World Geography	3
GEOG 1750 ¹⁰	Minnesota Geography	3
GEOG 1790	Special Topics in Geography	1-6
GLOS 1710 ⁸	Introduction to Global Studies	3
HIST 1730 ⁸	Contemporary World History	3
HIST 1745 ⁷	U.S. History to 1877	4
HIST 1746 ⁷	U.S. History since 1877	4
HIST 1750 ¹⁰	Minnesota History	3
HIST 1760 ⁸	History of World Civilizations to 1500	3
HIST 1761 ⁸	History of World Civilizations since 1500	3
HIST 1770 ⁹	History of Women in the United States	3
HIST 1773 ⁷	African American History	3
HIST 2740 ⁹	Immigration & Ethnic History of the United States	3
HIST 2780 ⁷	Special Topics in History	1-6
HIST 2790 ⁷	Historical Methods	2
POLS 1720 ⁹	Introduction to American Government	3
POLS 1740 ⁸	Introduction to World Politics	3
POLS 1750 ⁹	Introduction to Political Science	3
POLS 1760 ⁹	Introduction to Political Philosophy	3
POLS 1790 ⁹	Special Topics in Political Science	1-6
PSYC 1710	General Psychology	4
PSYC 1720 ⁹	Psychology throughout the Lifespan	3
PSYC 1740 ⁷	Abnormal Psychology (p)	4
PSYC 1750 ⁷	Introduction to Health Psychology	3
PSYC 1790	Special Topics in Psychology	1-6
PSYC 2720 ⁷	Social Psychology (p)	4
SOCI 1710 ⁷	Introduction to Sociology	4
SOCI 1720 ⁸	Social Problems	3
SOCI 1730 ⁷	Sociology of Families and Relationships	3

SOCI	1740 ⁸	Sociology of Work	3
SOCI	1760	Mass Media and Society	4
SOCI	1765 ⁷	Sociology of Crime and Deviance	3
SOCI	1766 ⁹	Juvenile Delinquency	3
SOCI	1772 ⁹	Introduction to Criminal Justice	3
SOCI	1774 ⁹	Introduction to Corrections	3
SOCI	1776 ⁹	Probation, Parole and Alternative Sentencing	3
SOCI	1790	Special Topics in Sociology	1-6
SOCI	2720 ⁷	Social Psychology (p)	4
WGST	1785 ⁹	Foundations in Women's Studies	3
WGST	1790 ⁹	Special Topics in Women's and Gender Studies	1-6

*Course contains lab (p) = Indicates prerequisite required for course

MnTC Goal 6: Humanities and Fine Arts Credits

ARTS	1713	Photography 1	3
ARTS	1714	Photography 2 (p)	3
ARTS	1717	Photography 3 (p)	3
ARTS	1720 ⁸	Art Appreciation	3
ARTS	1722 ⁷	American Animation	3
ARTS	1724 ⁷	The Design of Everyday Life	3
ARTS	1726 ⁷	Art in the Cities	3
ARTS	1730	Drawing 1	3
ARTS	1731	Drawing 2 (p)	3
ARTS	1732	Two-dimensional Design	3
ARTS	1733	Three-dimensional Design	3
ARTS	1740	Introduction to Painting	3
ARTS	1742	Intermediate Painting (p)	3
ARTS	1744	Introduction to Watercolor Painting	3
ARTS	1750	Introduction to Ceramics	3
ARTS	1752	Intermediate Ceramics (p)	3
ARTS	1756	Metal Arts	3
ARTS	1757	Metal Art 2 (p)	3
ARTS	1760 ⁸	World Art	3
ARTS	1770	Art in America	3
ARTS	1780	Beginning Printmaking	3
ARTS	1790	History of Photography	3
ARTS	1795	Special Topics in Art	1-6
ARTS	2710	Advanced Studio Arts	3-4
ARTS	2754	Advanced Ceramics (p)	3
ENGL	1720	Introduction to Creative Writing (p)	3
ENGL	1725	Introduction to Fiction Writing (p)	3

ENGL	1735	Introduction to Non-Fiction-Memoir Writing	3
ENGL	1770	Introduction to Poetry Writing	3
ENGL	1780 ⁷	Recently Arrived Contemporary Immigrant Literature (p)	3
ENGL	1790 ⁷	Contemporary Writers of Color (p)	3
ENGL	2721 ⁷	Survey of American Literature 1 (p)	3
ENGL	2722 ⁷	Survey of American Literature 2 (p)	3
ENGL	2725	Survey of British Literature (p)	3
ENGL	2730	Contemporary American Novel (p)	3
ENGL	2732	Exploring the Short Story (p)	3
ENGL	2740 ⁷	Native American Literature (p)	3
ENGL	2750 ⁷	African American Literature (p)	3
ENGL	2755 ⁷	LGBTQ Writers (p)	3
ENGL	2760	The English Novel (p)	3
ENGL	2770	Introduction to Poetry (p)	3
ENGL	2775	Introduction to Speculative Fiction and Fantasy Literature	3
ENGL	2776 ⁷	Women Writers (p)	3
ENGL	2778	Urban Literature – Lost in the City (p)	3
HUMA	1720 ⁸	The Ancient and Medieval World	4
HUMA	1730 ⁸	The Modern World	4
HUMA	1750 ⁸	Culture and Civilization: Spanish-Speaking Cultures	3
HUMA	1770	The Art of Film	3
HUMA	1780 ⁷	American Film	3
HUMA	1790 ⁸	International Film	3
HUMA	1795	Special Topics in Humanities	1-6
MUSC	1701	Music Theory 1	2
MUSC	1703	Music Theory 2 (p)	2
MUSC	1720	Fundamentals of Music	3
MUSC	1730	Concert Choir	2
MUSC	1735	Class Piano 1	2
MUSC	1736	Class Piano 2	2
MUSC	1740 ⁸	Music Appreciation	3
MUSC	1745 ⁷	History of Rock and Roll	3
MUSC	1750 ⁷	Jazz History	3
MUSC	1760 ⁷	American Music	3
MUSC	1765 ⁷	Music of Latin America and the Caribbean	3
MUSC	1770 ⁸	Music in World Cultures	3
MUSC	1790	Special Topics in Music	1-6
MUSC	1800	Music Production 1	3
MUSC	2700	Music Theory 3 (p)	2
MUSC	2710	Music Theory 4 (p)	2

MnTC Goal 6: Humanities and Fine Arts *continued*

MUSC	2713	Guitar Ensemble	2
MUSC	2720 ⁸	Music History 1: Medieval to Baroque (p)	3
MUSC	2721 ⁸	Music History 2: Classical to Modern (p)	3
MUSC	2800	Music Production 2 (p)	3
PHIL	1700	Introduction to Philosophy	3
PHIL	1715	Philosophy of Scientific Reasoning	3
PHIL	1720 ⁹	Ethics	3
PHIL	1722 ⁹	Health Care Ethics	3
PHIL	1724 ¹⁰	Environmental Ethics	3
PHIL	1742 ⁸	Greek & Roman Mythology	3
PHIL	1750 ⁸	Eastern Philosophy	3
PHIL	1760 ⁸	World Religions	3
PHIL	1770 ⁷	Feminist Philosophy	3
PHIL	1790	Special Topics in Philosophy	1-6
SPAN	1730 ⁸	Intermediate Spanish 1 (p)	5
SPAN	1740 ⁸	Intermediate Spanish 2 (p)	5
THTR	1710	Introduction to Theatre	3
THTR	1716 ⁸	Theatre Around the World	3
THTR	1725	Acting 1	3
THTR	1730	Theatre Stagecraft and Performance	3
THTR	1731	Theatre Performance. Practicum	1
THTR	1732	Technical Theatre Practicum	1
THTR	1740	Fundamentals of Playwriting: Playwriting 1	3
THTR	1790	Special Topics in Drama and Theatre	1-6
THTR	2725	Acting 2	3

*Course contains lab (p) = Indicates prerequisite required for course

MnTC Goal 7: Human Diversity **Credits**

ANTH	1710 ⁵	Introduction to Cultural Anthropology	4
ARTS	1722 ⁶	American Animation	3
ARTS	1724 ⁶	The Design of Everyday Life	3
ARTS	1726 ⁶	Art in the Cities	3
ASLS	1435	Deaf Studies/Culture	3
ENGL	1780 ⁶	Recently Arrived-Contemporary Immigrant Literature (p)	3
ENGL	1790 ⁶	Contemporary Writers of Color (p)	3
ENGL	2721 ⁶	Survey of American Literature 1 (p)	3
ENGL	2722 ⁶	Survey of American Literature 2 (p)	3
ENGL	2740 ⁶	Native American Literature (p)	3
ENGL	2750 ⁶	African American Literature (p)	3
ENGL	2755 ⁶	LGBTQ Writers (p)	3

ENGL	2776 ⁶	Women Writers (p)	3
COMM	1720 ¹	Interpersonal Communication	3
COMM	1770 ¹	Family Communication	3
COMM	1780 ¹	Gender Communication	3
HIST	1745 ⁵	U.S. History to 1877	4
HIST	1746 ⁵	U.S. History since 1877	4
HIST	1773 ⁵	African American History	3
HIST	2780 ⁵	Special Topics in History	1-6
HIST	2790 ⁵	Historical Methods	2
HUMA	1780 ⁶	American Film	3
MUSC	1745 ⁶	History of Rock and Roll	3
MUSC	1750 ⁶	Jazz History	3
MUSC	1760 ⁶	American Music	3
MUSC	1765 ⁶	Music of Latin America and the Caribbean	3
PHIL	1770 ⁶	Feminist Philosophy	3
PSYC	1740 ⁵	Abnormal Psychology (p)	4
PSYC	1750 ⁵	Introduction to Health Psychology	3
PSYC	2720 ⁵	Social Psychology (p)	4
SOCI	1710 ⁵	Introduction to Sociology	4
SOCI	1730 ⁵	Sociology of Families and Relationships	3
SOCI	1765 ⁵	Sociology of Crime and Deviance	3
SOCI	2720 ⁵	Social Psychology (p)	4

*Course contains lab (p) = Indicates prerequisite required for course

MnTC Goal 8: Global Perspective **Credits**

ANTH	1730 ⁵	Gender & Culture in Global Perspectives	3
ARTS	1720 ⁶	Art Appreciation	3
ARTS	1760 ⁶	World Art	3
ASLS	1411	American Sign Language 1	3
ASLS	1412	American Sign Language 2 (p)	3
ASLS	1413	American Sign Language 3 (p)	3
ASLS	1414	American Sign Language 4 (p)	3
CHIN	1710	Beginning Chinese 1	5
CHIN	1720	Beginning Chinese 2 (p)	5
CHIN	1790	Special Topics in Chinese	1-6
COMM	1700 ¹	Introduction to Communications	3
COMM	1710 ¹	Fundamentals of Public Speaking	3
COMM	1730 ¹	Intercultural Communication	3
ECON	1720 ⁵	Macroeconomics	3
ECON	1730 ⁵	Microeconomics	3
GEOG	1720 ⁵	Human / Cultural Geography	3
GEOG	1740 ⁵	World Geography	3

GLOS	1710 ⁵	Introduction to Global Studies	3
HIST	1730 ⁵	Contemporary World History	3
HIST	1760 ⁵	History of World Civilizations to 1500	3
HIST	1761 ⁵	History of World Civilizations since 1500	3
HUMA	1720 ⁶	The Ancient and Medieval World	4
HUMA	1730 ⁶	The Modern World	4
HUMA	1750 ⁶	Culture and Civilization: Spanish-Speaking Cultures	3
HUMA	1790 ⁶	International Film	3
MUSC	1740 ⁶	Music Appreciation	3
MUSC	1770 ⁶	Music in World Cultures	3
MUSC	2720 ⁶	Music History 1: Medieval to Baroque (p)	3
MUSC	2721 ⁶	Music History 2: Classical to Modern (p)	3
PHIL	1724 ¹⁰	Environmental Ethics	3
PHIL	1742 ⁶	Greek & Roman Mythology	3
PHIL	1750 ⁶	Eastern Philosophy	3
PHIL	1760 ⁶	World Religions	3
POLS	1740 ⁵	Introduction to World Politics	3
SOCI	1720 ⁵	Social Problems	3
SOCI	1740 ⁵	Sociology of Work	3
SPAN	1710	Beginning Spanish 1	5
SPAN	1720	Beginning Spanish 2 (p)	5
SPAN	1730 ⁶	Intermediate Spanish 1 (p)	5
SPAN	1740 ⁶	Intermediate Spanish 2 (p)	5
SPAN	1790	Spanish for the Workplace	3
SPAN	1795	Special Topics in Spanish	1-6
THTR	1716 ⁶	Theatre Around the World	3

*Course contains lab (p) = Indicates prerequisite required for course

MnTC Goal 9: Ethical & Civic Responsibility Credits

BIOL	1785 ³	Biology of Women	3
COMM	1740 ⁵	Mass Media & Communications	3
COMM	1750 ¹	Small Group Communication	3
HIST	1770 ⁵	History of Women in the United States	3
HIST	2740 ⁵	Immigration and Ethnic History of the United States	3
NSCI	1780 ³	Contemporary Issues in Science	3
PHIL	1720 ⁶	Ethics	3
PHIL	1722 ⁶	Health Care Ethics	3
POLS	1720 ⁵	Introduction to American Government	3
POLS	1750 ⁵	Introduction to Political Science	3
POLS	1760 ⁵	Introduction to Political Philosophy	3
POLS	1790 ⁵	Special Topics in Political Science	1-6

PSYC	1720 ⁵	Psychology throughout the Lifespan	3
SOCI	1766 ⁵	Juvenile Delinquency	3
SOCI	1772 ⁵	Introduction to Criminal Justice	3
SOCI	1774 ⁵	Introduction to Corrections	3
SOCI	1776 ⁵	Probation, Parole and Alternative Sentencing	3
WGST	1785 ⁵	Foundations in Women's Studies	3
WGST	1790 ⁵	Special Topics in Women's and Gender Studies	1-6

*Course contains lab (p) = Indicates prerequisite required for course

MnTC Goal 10: People & the Environment Credits

ANTH	1720 ⁵	Introduction to Physical Anthropology	4
BIOL	1725 ^{3*}	Environmental Science	4
BIOL	1745 ^{3*}	General Biology: The Living World (p)	5
GEOG	1700 ⁵	Physical Geography	3
GEOG	1750 ⁵	Minnesota Geography	3
HIST	1750 ⁵	Minnesota History	3
NSCI	1710 ^{3*}	Earth Science	4
NSCI	1721 ^{3*}	Introduction to Geology	4
NSCI	1730 ³	Introduction to Oceanography	3
NSCI	1740 ³	Introduction to Meteorology	3
NSCI	1750 ³	Natural Disasters	3
NSCI	1770 ³	Introduction to Energy and the Environment	3
NSCI	1782 ³	Minnesota Geology	3
NSCI	1790 ³	Special Topics in Natural Science	1-6
PHIL	1724 ¹⁰	Environmental Ethics	3
PHYS	1760 ³	Descriptive Astronomy (no lab)	3
PHYS	2760 ^{3*}	Introductory Astronomy (with lab)	4

*Course contains lab (p) = Indicates prerequisite required for course

Transfer to Other Institutions

To ensure a smooth transfer from Saint Paul College to a four-year college or university, it is important to understand the types of degrees offered at the College:

An Associate of Fine Arts (AFA) degree is designed for students who plan to transfer to a four-year college to pursue a Bachelor in Fine Arts Degree. It provides an exposure to the general education courses required by four-year Bachelor of Fine Arts Programs.

The Associate of Arts (AA) degree is designed for transfer and offers flexibility in terms of the variety of colleges to which a student can transfer and in the variety of majors that can be chosen. The AA degree requires mostly general education courses (40 credits), which is what gives it more transferability. The AA degree consists of the Minnesota Transfer Curriculum (MnTC). Completion of the MnTC with a 2.0 GPA meets the general education requirements at any of the public Minnesota State Colleges and Universities institutions and the University of Minnesota. Several private colleges also honor the AA degree. Some four-year majors require specific general education courses referred to as premajor requirements.

Note: Course requirements may vary depending on the major and transfer college, so it is important to talk to a Pathway Advisor at Saint Paul College and to the appropriate person at the transfer college. Refer to the General Transfer Table.

An Associate of Science (AS) degree is intended to prepare students for immediate employment; however, students can transfer to complete a Bachelor's degree when they transfer to colleges with which Saint Paul College has articulation agreements. In addition to technical requirements, the AS degree requires 30 credits of general education (MnTC) courses. Additional general education courses may be required to complete a Bachelor's degree, particularly if students transfer to a college where an articulation agreement does not exist.

An Associate of Applied Science (AAS) degree is intended mainly to prepare students for direct employment. Students who are following an AAS degree and who are interested in transfer are strongly advised to talk to a Saint Paul College Pathway Advisor in the Advising & Counseling Center as transfer options are more limited. In addition to technical requirements, the AAS degree requires 20 credits of general education (MnTC) courses. Additional general education courses typically would be required to complete a Bachelor's degree for students who transfer, particularly to colleges with which articulation agreements do not exist. Refer to the Transfer Articulation Agreements Table.

Understanding Transfer of Credits

The receiving college or university decides which credits transfer and if those credits meet its degree requirements; however, a course that meets a Minnesota Transfer Curriculum (MnTC) goal at Saint Paul College will meet the same goal at a Minnesota State Colleges and Universities institution.

Note: A course can meet a Minnesota Transfer Goal at the sending institution and yet may or may not be considered equivalent to a course at the receiving institution. The accreditation of both the sending and receiving institution can affect the transfer of credits earned, but it is not the only factor in determining transfer of credits. Institutions accept credits from courses and programs like those they offer. They

look for similarity in course goals, content and level: "like" transfers to "like." The name of a course is not sufficient to determine equivalency. Not everything that transfers counts toward graduation. Bachelor's degree programs usually count credits in three categories: general education, major/minor courses and prerequisites/electives. The key question is, "Will your credits fulfill requirements of the degree or program you choose?"

A change in career goal or major might make it difficult to complete all degree requirements within the usual number of graduation credits. Colleges and universities differ in how they accept courses and other types of college credits (CLEP, AP, IB, international credits, etc.).

Since requirements and acceptance of Saint Paul College credits differ from one college to another, it is important to talk to a Saint Paul College Pathway Advisor, consult college catalogs and websites and talk to advisors at the four-year institution. Pathway Advisors and other transfer resources are available in Advising and Counseling. Transfer guides to four-year institutions may be available to provide guidance in selecting the courses intended to transfer from Saint Paul College. Also access the Saint Paul College website (saintpaul.edu) or the Minnesota Transfer website (www.mntransfer.org) for more information.

Obtain the following materials and information from the four-year institution: college catalog, transfer brochure, information on financial aid (how to apply and by what date), information about admissions criteria and materials required for admission. (e.g., transcripts, test scores, portfolio, etc.). Note that some majors have limited enrollment and/or special admission requirements such as specific grade point averages.

Note: Minnesota State Colleges and Universities and the University of Minnesota have high school preparation requirements for admission. Consult an advisor at your intended transfer school for more information.

After reviewing this information, contact the Pathway Advisor or someone in the division or program of interest. Be sure to ask about course transfer and admissions criteria.

Applying for Transfer Admission at Other Institutions

Application for admission is the first step in transferring. Fill out the application early, prior to the deadline and enclose the required application fee. Request official transcripts be sent from all previously attended institutions. The student may also be required to provide a high school transcript or GED test scores.

Make certain the college or university has been supplied with all the necessary paperwork. Most colleges make no decisions until all required documents are filed. If nothing has been heard from the intended college of transfer after one month, call to check on application status.

After receiving notification of acceptance, transcribed credits will be evaluated for transfer. A written evaluation should explain which courses transfer and which do not. How courses specifically meet degree requirements may not be decided until orientation or selection of a major.

Contact the college of transfer with questions or to find out why judgments were made about specific courses. Each student has the right to an appeal. See Your Rights as a Transfer Student.

Your Rights as a Transfer Student

Students are entitled to:

- A clear, understandable statement of an institution's transfer policy.
- A fair credit review and an explanation of why credits were or were not accepted.
- A copy of the formal appeals process.
- A review of eligibility for financial aid or scholarships.

Steps in the Appeals Process:

1. The student fills out an appeals form. Supplemental information provided to reviewers can include: a syllabus, course description, or reading list, depending upon the type of appeal.
2. A review by the appropriate department or committee will be conducted.
3. The decision is conveyed in writing to the student.
4. The student may appeal the decision.

For help with transfer questions or concerns, contact the Pathway Advisor or your advisor at the transfer college.

Transfer Articulation Agreements

Saint Paul College has formed articulation agreements with a number of public and private institutions to assist students following some AS, AAS, diploma or certificate programs with their transfer goals. Please see a Pathway Advisor for further information.

General Transfer Table 2019-2020

For students following the Associate of Arts (AA) or other general transfer

The following table summarizes transfer to many colleges. Students who are planning to transfer to other institutions should work with Pathway Advisor at Saint Paul College and the college to which they are transferring. Certain majors require specialized coursework, so the following provides a guide for general transfer; it is not intended to cover specific requirements for all majors. Admission requirements may vary depending on the major the student is pursuing. Students should consult with the transfer college and use transfer guides to find out admission deadlines and requirements.

Note: Students are free to explore transfer to any college, including colleges not listed in the following table.

Transfer guides are also available in Advising and Counseling.

SAINT PAUL COLLEGE

Degree / Major Offered		Transfer Institution
AA/MnTC	Various Majors	All Minnesota State Colleges and Universities
AA/MnTC	Various Majors	Augsburg University
AA	Various Majors	Bethany Lutheran
Selected Liberal Arts Courses	Various Majors	Bethel University
AA/MnTC	Various Majors	College of St. Scholastica
AA/MnTC	Various Majors	Concordia University
Selected Liberal Arts Courses	Various Majors	Hamline University
AS/AAS	Individualized Studies	Metropolitan State University
Selected Liberal Arts Courses	Various Majors	Minneapolis College of Art and Design
Selected Liberal Arts Courses	Various Majors	St. Catherine University
AA/MnTC	Various Majors	Saint Mary's University Minneapolis
AA/MnTC	Various Majors	University of Minnesota
AA/MnTC	Various Majors	University of North Dakota
Selected Liberal Arts Courses	Various Majors	University of St. Thomas
AA/Selected Liberal Arts Courses	Various Majors	University of Wisconsin River Falls
AA/Selected Liberal Arts Courses	Various Majors	University of Wisconsin-Stout

Programs

Degree, Diploma and Certificate

References to the Minnesota Transfer Curriculum (MnTC)

Throughout the following program pages, the Minnesota Transfer Curriculum (MnTC) will be referenced regarding General Education requirements. The MnTC has specific credit requirements and ten goal areas. Some program areas will have specific general education course numbers listed as required

or recommended for MnTC goal areas. Notations such as “Goal 4: Mathematics/Logical Reasoning” will be listed instead of specific course numbers, which means that students may select specific courses from that MnTC goal area to fulfill the requirements of the program.

For example, if a program requires a non-specified, four-credit course in social or behavioral sciences, the program requirement would be listed as “Goal 5 – History, Social Science & Behavioral Sciences: 4 credits.” This means that any four-credit course listed under Goal 5 of the Minnesota General Education Transfer Curriculum could be used to fulfill that requirement.

It may be necessary for students to select additional MnTC credits beyond the minimum number required in each goal area in order to reach the total MnTC/General Education credits required for their degree or program.

The specific courses for each MnTC Goal Area are listed in this Catalog and on our website.

Program Requirement Guides

Program Requirement Guides for each individual program are available in One Stop and Advising & Counseling.

The guides are also available on our website at saintpaul.edu/ProgramGuides.

Business 31

Career & Technical Education 63

Health Science 95

Service 146

STEM: Science, Technology,
Engineering & Mathematics 169

Liberal & Fine Arts 206

Business Programs

The mission of the Business Department at Saint Paul College is to sustain the College mission by providing quality, lifelong business education supported by technology for a diverse, metropolitan student population.

Accounting

Accounting AAS Degree (60 Credits)	32-33
Accounting Technician Diploma (38 Credits).	34

Office Management Professional

Office Management Professional AAS Degree (60 Credits).	35-36
Business Certificate (16 Credits)	37
Customer Service Office Support Certificate (27 credits)	38

Business

Business Transfer Pathway AS Degree (60 Credits)	39-40
Nonprofit Certificate (27 Credits)	41

Project Management

Project Management AAS Degree (60 Credits). . . .	42-43
Project Management Certificate (21 Credits)	44

Entrepreneurship

Entrepreneurship Certificate (24 Credits)	45
---	----

Finance

Finance AS Degree (60 Credits)	46-47
--	-------

Global Trade

Global Trade Specialist AAS Degree (60 Credits).	48-49
Global Trade Professional Certificate (16 Credits).	50

Hospitality Management

Hospitality Management AAS Degree (60 Credits).	51-52
Event and Meeting Management Certificate (18 Credits)	53

Human Resource Management

Human Resources AAS Degree (60 Credits)	54-55
Human Resources Certificate (25 Credits).	56

Marketing

Marketing AAS Degree (60 Credits)	57-58
Social Media Marketing Certificate (17 Credits)	59

Supply Chain Logistics

Supply Chain Logistics AAS Degree (60 Credits) . .	60-61
Supply Chain Logistics Certificate (19 Credits)	62

Accounting AAS DEGREE

Program Overview

An accountant examines, analyzes, and interprets accounting data for the purpose of giving advice and preparing financial statements. Duties may include performing such activities as recording receipts and disbursements, and preparing state and federal reports. The accountant may prepare reports and statements on a computer or manually.

Excellent reading skills and a combination of interest and ability to concentrate on detail, an analytical mind, good judgment and absolute integrity are necessary for success in the field of accounting.

Career Opportunities

With more and more emphasis being placed on computer usage for accounting careers, opportunities for employment in this field are excellent. Rate of advancement may be swift and the rewards generous.

The accounting profession offers a vast arena of employment potential. Typical places of employment include accounting departments in governmental agencies, financial institutions, private business and industry, and public accounting firms. Other job titles may be tax accountant, cost accountant, staff accountant, government accountant, auditor or junior accountant. The financial accounting technician positions are found in the areas of public accounting, private accounting, non-profit accounting, auditing, taxation, cost accounting and managerial positions.

Program Outcomes

1. Graduates will possess the knowledge and skills for immediate employment in related business support areas.
2. Graduates will be proficient in computer software and its application to financial accounting, taxation, and financial analysis.
3. Graduates will have knowledge of financial accounting theory and financial statement analysis.
4. Graduates will have completed general education requirements for employment and personal roles.
5. Graduates will serve their employers and clients in all phases of accounting, including financial accounting, managerial accounting and tax accounting.
6. Graduates will have critical thinking skills.

Program Faculty

Jim O'Halloran james.o'halloran@saintpaul.edu
651.846.1436

Part-time/Full-time Options

Some day, evening, and Saturday class availability. Students may attend full-time or part-time.

Program Requirements

Check off when completed

Required Business Core Cr

Professional Component

- ACCT 2410 Financial Accounting. 4
- BTEC 1421 Business Information Applications 1 . . . 3
- BUSN 1410 Introduction to Business 3
- BUSN 1449 Business Communications. 3
- BUSN 2465 Business Ethics 3
- Required Business Core 16**

Course Cr

- ACCT 1410 Introduction to Accounting. 2
- ACCT 1511 Federal Taxation 1. 4
- ACCT 1512 Federal Taxation 2. 4
- ACCT 1515 Payroll Processing 3
- ACCT 1523 Accounting Computer Applications. . . 3
- ACCT 2411 Intermediate Accounting 4
- ACCT 2420 Managerial Accounting. 4
- ACCT 2540 Financial Modeling for Spreadsheets . . 4
- Subtotal. 28**

General Education/MnTC Requirements Cr

- Refer to the Minnesota Transfer Curriculum Course List for each Goal Area
- Goal 1: Communication. 7
ENGL 1711 Composition 1 – 4 cr
COMM 17XX – 3 cr
 - Goal 3 or Goal 4. 3
Goal 3: Natural Sciences OR
Goal 4: Mathematical/Logical Reasoning
 - Goal 5: History, Social Science, and Behavioral Sciences 3
ECON 1720 Macroeconomics – 3 cr OR
ECON 1730 Microeconomics – 3 cr
 - Goal 6: Humanities and Fine Arts. 3
 - General Education Requirements 16**

Total Program Credits 60

Program Start Dates

Fall, Spring, Summer

Transfer Opportunities

Saint Paul College has a transfer articulation agreement between the following program and post-secondary institutions for the baccalaureate degree programs listed below.

For more information please go to saintpaul.edu/Transfer.

Accounting AAS

- BA Individualized Studies
Metropolitan State University
- BBA Accounting
Concordia University, St. Paul
- BBA Finance
Concordia University, St. Paul
- BS Accounting
Saint Mary's University,
Twin Cities Campus
- BS Applied Management
Dunwoody College of Technology
- BS Business Management
Herzing University

Course Sequence

The course sequence listed on the back of this guide is recommended for a full-time student; however, this sequence is not required. Contact Program Faculty with questions.

See back of this guide for Course Sequence

Minimum Program Entry Requirements

Students entering this program must meet the following minimum program entry requirements:

Reading: Score of 78+ or grade of "C" or better in READ 0722

Writing: Score of 78+ or grade of "C" or better in ENGL 0922

Arithmetic: Score of 52+ or grade of "C" or better in MATH 0745

Assessment Results and Prerequisites: Students admitted into Saint Paul College programs may need to complete additional courses based on assessment results and course prerequisite requirements. Certain MATH, READ, and ENGL courses have additional prerequisites.

002A (7041)



The mission of the Business Department at Saint Paul College is to sustain the College mission by providing quality, lifelong business education supported by technology for a diverse, metropolitan student population.

*Information is subject to change.
This Program Requirements Guide is not a contract.*

Accreditation Council for Business Schools and Programs

Accounting AAS DEGREE *(continued)*

Full-Time Course Sequence

The following sequence is recommended for a full-time student; however, this sequence is not required. Contact Program Faculty with questions.

First Semester

ACCT 1410 Introduction to Accounting	2
ACCT 1515 Payroll Processing	3
ACCT 1523 Accounting Computer Applications	3
BUSN 1410 Introduction to Business	3
Goal 1: COMM 17XX	3
Total Semester Credits.	14

Second Semester

ACCT 2410 Financial Accounting	4
BTEC 1421 Business Information Applications 1	3
BUSN 1449 Business Communications	3
BUSN 2465 Business Ethics	3
Goal 5: ECON 1720 Macroeconomics OR ECON 1730 Microeconomics	3
Total Semester Credits.	16

Third Semester

ACCT 1511 Federal Taxation 1	4
ACCT 2420 Managerial Accounting	4
Goal 1: ENGL 1711 Composition 1	4
Goal 6: Humanities and Fine Arts	3
Total Semester Credits.	15

Fourth Semester

ACCT 1512 Federal Taxation 2	4
ACCT 2411 Intermediate Accounting	4
ACCT 2540 Financial Modeling for Spreadsheets	4
Goal 3: Natural Sciences OR Goal 4: Mathematical/Logical Reasoning	3
Total Semester Credits.	15

Total Program Credits60

Part-Time Course Sequence

The following sequence is recommended for a part-time student; however, this sequence is not required. Contact Program Faculty with questions.

First Semester

ACCT 1410 Introduction to Accounting	2
ACCT 1515 Payroll Processing	3
ACCT 1523 Accounting Computer Applications	3
BUSN 1410 Introduction to Business	3
Total Semester Credits.	11

Second Semester

ACCT 2410 Financial Accounting	4
BUSN 1449 Business Communications	3
Goal 1: COMM 17XX	3
Total Semester Credits.	10

Third Semester

ACCT 1511 Federal Taxation 1	4
BUSN 2465 Business Ethics	3
Goal 5: ECON 1720 Macroeconomics OR ECON 1730 Microeconomics	3
Total Semester Credits.	10

Fourth Semester

ACCT 2420 Managerial Accounting	4
Goal 1: ENGL 1711 Composition 1	4
Goal 6: Humanities and Fine Arts	3
Total Semester Credits.	11

Fifth Semester

ACCT 1512 Federal Taxation 2	4
ACCT 2411 Intermediate Accounting	4
Total Semester Credits.	8

Sixth Semester

ACCT 2540 Financial Modeling for Spreadsheets	4
BTEC 1421 Business Information Applications 1	3
Goal 3: Natural Sciences OR Goal 4: Mathematical/Logical Reasoning	3
Total Semester Credits.	10

Total Program Credits60

Accounting Technician DIPLOMA

Program Overview

The Accounting Technician monitors and controls various types of electronic data processing equipment used to process accounting data. Applications would include automated general ledger and other accounting subsystems, spreadsheet applications and database management. The Accounting Technician may also assist in the planning and implementation of automated accounting systems.

Excellent reading skills and a combination of interest and ability to concentrate on detail, an analytical mind, good judgment and absolute integrity are necessary for success in the field of accounting.

Career Opportunities

With more and more emphasis being placed on computer usage for accounting careers, opportunities for employment in this field are excellent. Rate of advancement may be swift and the rewards generous.

The Accounting profession offers a vast arena of employment potential. Typical places of employment include accounting departments in governmental agencies, financial institutions, private business and industry, and public accounting firms. Other job titles may be tax accountant, cost accountant, staff accountant, government accountant, auditor or junior accountant. The financial accounting technician positions are found in the areas of public accounting, private accounting, non-profit accounting, auditing, taxation, cost accounting and managerial positions.

Program Outcomes

1. Graduates will possess the knowledge and skills for immediate employment in related business support areas.
2. Graduates will be proficient in computer software and its application to financial accounting, taxation, and financial analysis.
3. Graduates will have knowledge of financial accounting theory and financial statement analysis.
4. Graduates will serve their employers and clients in all phases of accounting, including financial accounting, managerial accounting and tax accounting.

Program Faculty

Jim O'Halloran james.o'halloran@saintpaul.edu
651.846.1436

Part-time/Full-time Options

Some day, evening, and Saturday class availability. Students may attend full-time or part-time.

Program Requirements

Check off when completed

Course	Cr
<input type="checkbox"/> ACCT 1410 Introduction to Accounting	2
<input type="checkbox"/> ACCT 1511 Federal Taxation 1	4
<input type="checkbox"/> ACCT 1512 Federal Taxation 2	4
<input type="checkbox"/> ACCT 1515 Payroll Processing	3
<input type="checkbox"/> ACCT 1523 Accounting Computer Applications	3
<input type="checkbox"/> ACCT 2410 Financial Accounting	4
<input type="checkbox"/> ACCT 2411 Intermediate Accounting	4
<input type="checkbox"/> ACCT 2420 Managerial Accounting	4
<input type="checkbox"/> ACCT 2540 Financial Modeling for Spreadsheets	4
<input type="checkbox"/> BTEC 1421 Business Information Applications 1	3
Subtotal	35
General Education/MnTC Requirements	
Refer to the Minnesota Transfer Curriculum Course List for each Goal Area	
<input type="checkbox"/> Goal 1: Communication	3
COMM 17XX – 3 cr	
General Education Requirements	3
Total Program Credits	38

Program Start Dates

Fall, Spring, Summer

Course Sequence

The following sequence is recommended for a full-time student; however, this sequence is not required. Contact Program Faculty with questions.

First Semester

ACCT 1410 Introduction to Accounting	2
ACCT 1515 Payroll Processing	3
ACCT 1523 Accounting Computer Applications	3
BTEC 1421 Business Information Applications 1	3
Goal 1: COMM 17XX	3
Total Semester Credits	14

Second Semester

ACCT 1511 Federal Taxation 1	4
ACCT 2410 Financial Accounting	4
ACCT 2540 Financial Modeling for Spreadsheets	4
Total Semester Credits	12

Third Semester

ACCT 1512 Federal Taxation 2	4
ACCT 2411 Intermediate Accounting	4
ACCT 2420 Managerial Accounting	4
Total Semester Credits	12

Total Program Credits **38**

Minimum Program Entry Requirements

Students entering this program must meet the following minimum program entry requirements:

Reading: Score of 78+ or grade of "C" or better in READ 0722

Writing: Score of 78+ or grade of "C" or better in ENGL 0922

Arithmetic: Score of 52+ or grade of "C" or better in MATH 0745

Assessment Results and Prerequisites:

Students admitted into Saint Paul College programs may need to complete additional courses based on assessment results and course prerequisite requirements. Certain MATH, READ, and ENGL courses have additional prerequisites.

003D (7002)

*Information is subject to change.
This Program Requirements Guide is not a contract.*

Office Management Professional AAS DEGREE

Program Overview

This program will provide training for an office management professional position. Students will be trained in Microsoft Office software Excel, Word, PowerPoint Access, and Outlook. Customer service skills for internal and external customers will be emphasized. Students will learn communication, customer service, teamwork, conflict resolution, negotiation skills and problem solving skills. Events planning and project management skills will also be introduced.

Career Opportunities

1. Office Management Professional
2. Administrative Assistant
3. Customer Service Representative
4. Office Manager

Program Outcomes

1. Graduates will obtain the knowledge to plan, direct, and coordinate supportive services of an organization.
2. Graduates will have working knowledge of business information applications.
3. Graduates will have the skills to manage staff, information, and facilities.

Transfer Opportunities

Saint Paul College has a transfer articulation agreement between the following program and post-secondary institutions for the baccalaureate degree programs listed below.

For more information please go to saintpaul.edu/Transfer.

Office Management Professional AAS

- | | |
|-----|--|
| BA | Organizational Management and Leadership
Concordia University, St. Paul |
| BA | Individualized Studies
Metropolitan State University |
| BAS | Organizational Administration
Metropolitan State University |
| BS | Business Administration
Saint Mary's University,
Twin Cities Campus |
| BS | Business
Saint Mary's University,
Twin Cities Campus |



The mission of the Business Department at Saint Paul College is to sustain the College mission by providing quality, lifelong business education supported by technology for a diverse, metropolitan student population.

Accreditation Council for Business Schools and Programs

Program Faculty

Alli Vainshtein alli.vainshtein@saintpaul.edu
651.846.1529

Part-time/Full-time Options

This program can be completed by using a combination of day, evening and online courses. Part-time and full-time options are available.

Program Requirements

Check off when completed

Required Business Core Cr

Professional Component

- ACCT 2410 Financial Accounting 1 4
- BTEC 1421 Business Information Applications 1 . . . 3
- BUSN 1410 Introduction to Business 3
- BUSN 1449 Business Communications. 3
- BUSN 2465 Business Ethics 3
- Required Business Core 16**

Required Technical Courses Cr

- BTEC 1410 Advanced Keyboarding Applications . . 3
- BTEC 1423 Business Information Applications 2 . . 4
- BTEC 2410 Business Procedures 4
- BTEC 2506 Business Information Applications 3 . . 4
- BUSN 1520 Customer Service 3
- BUSN 2450 Management Fundamentals 3
- BUSN 2472 Business Negotiation Skills 3
- HSPM 1440 Event Management & Planning 3
- Subtotal 27**

General Education/MnTC Requirements Cr

Refer to the Minnesota Transfer Curriculum Course List for each Goal Area

- Goal 1: Communication 7
ENGL 1711 Composition 1 – 4 cr
COMM 17XX – 3 cr
- Goal 3 or Goal 4 4
Goal 3: Natural Sciences OR
Goal 4: Mathematical/Logical Reasoning
- Goal 5: History, Social Science, and Behavioral Sciences 3
ECON 1720 Macroeconomics – 3 cr OR
ECON 1730 Microeconomics – 3 cr
- Goal 6: Humanities and Fine Arts. 3
- General Education Requirements 17**

Total Program Credits 60

*Information is subject to change.
This Program Requirements Guide is not a contract.*

Program Start Dates

Fall, Spring, Summer

Course Sequence

The course sequence listed on the back of this guide is recommended for a full-time student; however, this sequence is not required. Contact Program Faculty with questions.

See back of this guide for Course Sequence

Minimum Program Entry Requirements

Students entering this program must meet the following minimum program entry requirements:

Reading: Score of 78+ or grade of "C" or better in READ 0722

Writing: Score of 78+ or grade of "C" or better in ENGL 0922

Arithmetic: Score of 20+

Keyboarding Skills: Minimum of 40 WPM with 3 errors or less or a grade of "C" or better in BTEC 1400.

Computer Skills: Basic computer skills such as word processing, spreadsheets, and Internet usage or a grade of "C" or better in BTEC 1418.

Assessment Results and Prerequisites:

Students admitted into Saint Paul College programs may need to complete additional courses based on assessment results and course prerequisite requirements. Certain MATH, READ, and ENGL courses have additional prerequisites.

384A (7217)

Office Management Professional AAS DEGREE *(continued)*

Course Sequence

The following sequence is recommended for a full-time student; however, this sequence is not required. Contact Program Faculty with questions.

First Semester

ACCT 2410 Financial Accounting	4
BTEC 1421 Business Info Applications 1	3
BUSN 1410 Introduction to Business	3
BUSN 1449 Business Communications	3
BUSN 2465 Business Ethics	3
Total Semester Credits	16

Second Semester

BTEC 1410 Advanced Keyboarding Applications	3
BTEC 1423 Business Information Applications 2	4
BUSN 1520 Customer Service (spring only)	3
Goal 1: COMM 17XX	3
Goal 5: ECON 1720 Macroeconomics OR ECON 1730 Microeconomics	3
Total Semester Credits	16

Third Semester

BUSN 2450 Management Fundamentals	3
BUSN 2472 Business Negotiation Skills	3
Goal 1: ENGL 1711 Composition 1	4
Goal 3: Natural Sciences OR Goal 4: Mathematical/Logical Reasoning	4
Total Semester Credits	14

Fourth Semester

BTEC 2410 Business Procedures	4
BTEC 2506 Business Information Applications 3 (spring only)	4
HSPM 1440 Event Management & Planning (spring only)	3
Goal 6: Humanities & Fine Arts	3
Total Semester Credits	14

Total Program Credits	60
--	-----------

Business CERTIFICATE

Program Overview

The business certificate consists of five business core classes that are required for all business degree majors. After completion, students may decide at that time which business degree program they would like to complete. This certificate provides a basic understanding of business.

Career Opportunities

There are many opportunities in the business area based on the individual's strengths and interests. Employment for entry level positions is expected to grow in the service and professional business industries. Students completing the Business Certificate can provide support for businesses.

Program Outcomes

1. Graduates will possess the basic knowledge and skills for entry level employment in related business support areas.
2. Graduates will be proficient in Microsoft Office applications.
3. Graduates will have understanding of core business practices.
4. Graduates will be knowledgeable in the use of business administration skills.

Program Faculty

Alli Vainshtein alli.vainshtein@saintpaul.edu
651.846.1529

Part-time/Full-time Options

Classes are offered day, evening, weekend and online. Students may attend full-time or part-time.

Program Requirements

Check off when completed

Course	Cr
<input type="checkbox"/> ACCT 2410 Financial Accounting	4
<input type="checkbox"/> BTEC 1421 Business Information Applications 1	3
<input type="checkbox"/> BUSN 1410 Introduction to Business	3
<input type="checkbox"/> BUSN 1449 Business Communications	3
<input type="checkbox"/> BUSN 2465 Business Ethics	3

Total Program Credits 16

Program Start Dates

Fall, Spring, Summer

Course Sequence

The following sequence is recommended for a full-time student. Students can complete this certificate in one semester. All courses are offered fall, spring and summer semester.

First Semester

ACCT 2410 Financial Accounting	4
BTEC 1421 Business Information Applications 1	3
BUSN 1410 Introduction to Business	3
BUSN 1449 Business Communications	3
BUSN 2465 Business Ethics	3

Total Program Credits 16

Minimum Program Entry Requirements

Students entering this program must meet the following minimum program entry requirements:

Reading: Score of 78+ or grade of "C" or better in READ 0722

Writing: Score of 78+ or grade of "C" or better in ENGL 0922

Arithmetic: Score of 20+

Assessment Results and Prerequisites:

Students admitted into Saint Paul College programs may need to complete additional courses based on assessment results and course prerequisite requirements. Certain MATH, READ, and ENGL courses have additional prerequisites.

Degree option may have a greater requirement than this certificate.

331C (7166)

*Information is subject to change.
This Program Requirements Guide is not a contract.*

Customer Service Office Support CERTIFICATE

Program Overview

This program provides entry level training for a customer service position. Students will learn how to resolve conflict, develop listening skills, interpersonal and problem solving skills. The program covers Microsoft Office Software: Excel, Word, PowerPoint, Access and Outlook. Students will also learn communication, teamwork, and other business professional skills.

Career Opportunities

1. Customer Service Representative
2. Account Representative
3. Bank Teller

Program Outcomes

1. Graduates will possess the basic knowledge and skills required for entry level customer service roles.
2. Graduates will reflect professional standards, ethics, and social responsibility.
3. Graduates will develop skills in effective communication, problem solving techniques, and professional behavior.

Program Faculty

Alli Vainshtein alli.vainshtein@saintpaul.edu
651.846.1529

Class Options

This program can be completed by using a combination of day, evening, and online classes. Part-time and full-time options are available.

Program Requirements

Check off when completed

Required Courses	Cr
<input type="checkbox"/> BTEC 1410 Advanced Keyboarding	3
<input type="checkbox"/> BTEC 1421 Business Information Applications 1	3
<input type="checkbox"/> BTEC 1423 Business Information Applications 2	4
<input type="checkbox"/> BTEC 1530 Communication Technology	4
<input type="checkbox"/> BTEC 2410 Business Procedures	4
<input type="checkbox"/> BUSN 1449 Business Communications	3
<input type="checkbox"/> BUSN 1520 Customer Service	3
<input type="checkbox"/> BUSN 2465 Business Ethics	3
Total Program Credits	27

Program Start Dates

Fall, Spring, Summer

Course Sequence

The following sequence is recommended for a full time student; however, this sequence is not required. Contact Program Faculty for questions.

First Semester

BTEC 1410 Advanced Keyboarding	3
BTEC 1421 Business Information Applications 1	3
BUSN 1449 Business Communications	3
BTEC 1530 Communication Technology.	4
Total Semester Credits.	13

Second Semester

BTEC 1423 Business Information Applications 2	4
BUSN 1520 Customer Service (spring only)	3
BTEC 2410 Business Procedures.	4
BUSN 2465 Business Ethics.	3
Total Semester Credits.	14

Total Program Credits 27

Minimum Program Entry Requirements

Students entering this program must meet the following minimum program entry requirements:

Reading: Score of 78+ or grade of C or better in READ 0722

Writing: Score of 78+ or grade of C or better in ENGL 0922

Arithmetic: Score of 20+

Keyboarding Skills: Minimum of 25 WPM with 3 errors or less or a grade of C or better in BTEC 1400

Computer Skills: Basic computer skills such as word processing, spreadsheets, and Internet usage or a grade of C or better in BTEC 1418.

Assessment Results and Prerequisites: Students admitted into Saint Paul College programs may need to complete additional courses based on assessment results and course prerequisite requirements. Certain MATH, READ, and ENGL courses have additional prerequisites.

Degree option may have a greater requirement than this certificate.

386C (7215)

*Information is subject to change.
This Program Requirements Guide is not a contract.*

Business Transfer Pathway AS DEGREE

Program Overview

This degree is designed for students to continue their education in business towards a bachelor's degree at four-year institutions. Bachelor degree majors include Management, Marketing, Accounting, Human Resources, and International Business. The Business Transfer Pathway AS degree prepares students for general management responsibilities. Students learn about the functions of business, including accounting, management, marketing, and human resources. Students study a broad background of business and liberal arts subjects that prepare them for entry-level positions in business. This program is also available completely online.

Career Opportunities

Employment opportunities are very good for skilled, capable, and dependable business professionals. Employers are looking for business professionals with excellent communication skills, organizational skills, human relation skills and enthusiasm for the job and organization. Graduates should continue their education towards a bachelor's degree or begin work in a variety of settings. Graduates can explore opportunities that match their interests and education in a variety of industries.

Program Outcomes

1. Graduates will have the skills, knowledge, and abilities, in core business functions.
2. Graduates will have a basic understanding of the ethics that impact the business environment.
3. Graduates will be prepared to transfer to another college or university to complete a bachelors program.
4. Graduates will have successfully mastered the general education requirements for work and life roles.



The mission of the Business Department at Saint Paul College is to sustain the College mission by providing quality, lifelong business education supported by technology for a diverse, metropolitan student population.

Accreditation Council for Business Schools and Programs

Information is subject to change.
This Program Requirements Guide is not a contract.

Program Faculty

- Evan Barshack evan.barshack@saintpaul.edu
651.846.1355
- Craig Maus craig.maus@saintpaul.edu
651.846.1531
- Jon Stambaugh jon.stambaugh@saintpaul.edu
651.846.1592

Part-time/Full-time Options

This program can be completed by using a combination of day, evening, Saturday and online courses. Part-time and full-time options are available.

Program Requirements

Check off when completed

Required Business Core Cr

Professional Component

- ACCT 2410 Financial Accounting 4
- BTEC 1421 Business Information Applications 1 . . . 3
- BUSN 1410 Introduction to Business 3
- BUSN 1449 Business Communications 3
- BUSN 2465 Business Ethics 3
- Required Business Core 16**

Course Cr

- ACCT 2420 Managerial Accounting 4
- BUSN 1480 Business Career Resources 1
- BUSN 2110 Principles of Marketing 3
- BUSN 2450 Management Fundamentals 3
- BUSN 2470 Legal Environment of Business 3
- Subtotal 14**

General Education/MnTC Requirements Cr

Refer to the Minnesota Transfer Curriculum Course List for each Goal Area

- Goal 1: Communication 9
 - ENGL 1711 Composition 1 – 4 cr
 - ENGL 1712 Composition 2 – 2 cr
 - COMM 17XX – 3cr
- Goal 3: Natural Science 4
 - BIOL 1725 Environmental Science – 4 cr
- Goal 4: Mathematical/Logical Reasoning. 7
 - MATH 1730 College Algebra 3
 - MATH 1740 Introduction to Statistics 4
- Goal 5: History, Social Science and Behavioral Sciences 6
 - ECON 1720 Macroeconomics – 3 cr
 - ECON 1730 Microeconomics – 3 cr
- Goal 6: Humanities and Fine Arts 3
- Goals 1-10 of the Minnesota Transfer Curriculum 1
 - Select a minimum of 1 additional credits
- General Education Requirements 30**

Total Program Credits 60

Program Start Dates

Fall, Spring, Summer

Course Sequence

The course sequence listed on the back of this guide is recommended for a full-time student; however, this sequence is not required. Contact Program Faculty with questions.

See back of this guide for Course Sequence & Transfer Opportunities

Minimum Program Entry Requirements

Students entering this program must meet the following minimum program entry requirements:

Reading: Score of 78+ or grade of "C" or better in READ 0722

Writing: Score of 78+ on Reading Comprehension or grade of "C" or better in ENGL 0922

College Level Mathematics: Score of 50+ or grade of "C" or better in MATH 0920

Assessment Results and Prerequisites: Students admitted into Saint Paul College programs may need to complete additional courses based on assessment results and course prerequisite requirements. Certain MATH, READ, and ENGL courses have additional prerequisites.

TPBU

Business Transfer Pathway AS DEGREE *(continued)*

Course Sequence

The following sequence is recommended for a full-time student; however, this sequence is not required. Contact Program Faculty with questions.

First Semester

BTEC 1421 Business Info Applications 1	3
BUSN 1410 Introduction to Business	3
BUSN 1449 Business Communications	3
Goal 1: ENGL 1711 Composition 1	4
Goal 4: MATH 1730 College Algebra	3
Total Semester Credits	16

Second Semester

ACCT 2410 Financial Accounting	4
BUSN 2110 Principles of Marketing	3
BUSN 2465 Business Ethics	3
Goal 4: MATH 1740 Introduction to Statistics	4
Total Semester Credits	14

Third Semester

ACCT 2420 Managerial Accounting	4
BUSN 2450 Management Fundamentals	3
BUSN 2470 Legal Environment of Business	3
Goal 5: ECON 1720 Macroeconomics	3
Goal 1: COMM 17XX	3
Total Semester Credits	16

Fourth Semester

Goal 1: ENGL 1712 Composition 2	2
Goal 3: BIOL 1725 Environmental Science	4
BUSN 1480 Business Career Resources	1
Goal 5: ECON 1730 Microeconomics	3
Goal 6: Humanities and Fine Arts	3
Mn Transfer Curriculum	1
Total Semester Credits	14
Total Program Credits	60

Transfer Opportunities

Saint Paul College has a transfer articulation agreement between the following program and post-secondary institutions for the baccalaureate degree programs listed below. For more information please go to saintpaul.edu/Transfer.

Business Transfer Pathway AS

BS	Business Administration	Bemidji State University
BA	Individualized Studies	
BS	Business Administration	
BS	Entrepreneurship Innovation	
BS	Finance	
BS	Human Resource Management	
BS	International Business	
BS	Management	
BS	Supply Chain Operations	Metropolitan State University
BS	Finance	
BS	International Business	
BS	Management	Minnesota State University, Mankato
BS	Business Administration	(online & on-campus)
		Minnesota State University, Moorhead
BS	Accounting	
BS	Business Administration	Saint Mary's University, Twin Cities Campus
BS	Management	Southwest Minnesota State University
BS	Human Resources Management	
BS	Management	
BS	Operations Management	St. Cloud State University
BS	Business Administration	Winona State University

Nonprofit CERTIFICATE

Program Overview

The Nonprofit Certificate program is designed for students who are currently working in the nonprofit sector or for those who desire an introductory perspective on the unique issues facing a nonprofit organization. This certificate program consists of 12 courses geared to provide the essential information of nonprofit business. These courses are delivered in a timely manner designed to fit your busy work and family schedules. Students will examine the fundamental principles of nonprofit, the roles and responsibilities of a nonprofit board of directors and the management team, the essential aspects of fundraising, and the fundamentals of the budgeting process.

Nonprofit organizations face new challenges: government funding cutbacks, growing numbers of clients, and the expanding need to acquire and manage financial resources. Nonprofit organizations must find ways to meet these challenges.

Enrolling in this certificate program will provide you with knowledge designed to empower the nonprofit organization employee with the skills necessary to succeed. For those who work in, or desire to work in, a nonprofit organization or business environment, this is the program for you!

Program Outcomes

1. Graduates will examine the fundamental principles of the nonprofit organization, as well as roles and responsibilities of nonprofit board of directors, volunteers, and the management team.
2. Graduates will develop practical and managerial skills necessary to plan operational success.
3. Graduates will understand financial and accounting terms.
4. Graduates will develop the skills of the marketing process.
5. Graduates will learn the basics of employment law, compliance and regulatory requirements.
6. Graduates will examine the foundational aspects of fundraising and grant writing and how to maximize those opportunities.
7. Graduates will develop a successful leadership style.
8. Graduates will gain confidence and improve communication skills.
9. Graduates will explore the process of negotiating and evaluate negotiation styles.

Program Faculty

Evan Barshack evan.barshack@saintpaul.edu
651.846.1355

Jon Stambaugh jon.stambaugh@saintpaul.edu
651.846.1592

Part-time/Full-time Options

Some day, evening, Saturday and online class availability. Students may attend full-time or part-time.

Program Requirements

Check off when completed

Course	Cr
<input type="checkbox"/> ACCT 2410 Financial Accounting	4
<input type="checkbox"/> BUSN 1449 Business Communications	3
<input type="checkbox"/> BUSN 2440 Fundamentals of Nonprofit Management	3
<input type="checkbox"/> BUSN 2441 Fundraising Techniques	1
<input type="checkbox"/> BUSN 2442 Grant Writing and Research	1
<input type="checkbox"/> BUSN 2443 Dynamics of Board Relations	1
<input type="checkbox"/> BUSN 2444 Volunteer Program Management	1
<input type="checkbox"/> BUSN 2445 Nonprofit Law and Ethics	1
<input type="checkbox"/> BUSN 2450 Management Fundamentals	3
<input type="checkbox"/> BUSN 2465 Business Ethics	3
<input type="checkbox"/> BUSN 2472 Business Negotiation Skills	3
<input type="checkbox"/> BUSN 2473 Project Management	3
Total Program Credits	27

Program Start Dates

Fall, Spring, Summer

Course Sequence

The following sequence is recommended for a full-time student; however, this sequence is not required. Contact Program Faculty with questions.

First Semester

ACCT 2410 Financial Accounting	4
BUSN 1449 Business Communications	3
BUSN 2440 Fundamentals of Nonprofit Management (fall only)	3
BUSN 2444 Volunteer Program Management (fall only)	1
BUSN 2445 Nonprofit Law and Ethics (fall only)	1
Total Semester Credits	12

Second Semester

BUSN 2441 Fundraising Techniques (spring only)	1
BUSN 2442 Grant Writing and Research (spring only)	1
BUSN 2443 Dynamics of Board Relations (spring only)	1
BUSN 2450 Management Fundamentals	3
BUSN 2465 Business Ethics	3
BUSN 2472 Business Negotiation Skills	3
BUSN 2473 Project Management (spring only)	3
Total Semester Credits	15

Total Program Credits 27

Minimum Program Entry Requirements

Students entering this program must meet the following minimum program entry requirements:

Reading: Score of 78+ or grade of "C" or better in READ 0722

Writing: Score of 78+ or grade of "C" or better in ENGL 0922

Arithmetic: Score of 20+

Assessment Results and Prerequisites:

Students admitted into Saint Paul College programs may need to complete additional courses based on assessment results and course prerequisite requirements. Certain MATH, READ, and ENGL courses have additional prerequisites.

Degree option may have a greater requirement than this certificate.

304C (7156)

*Information is subject to change.
This Program Requirements Guide is not a contract.*

Project Management AAS DEGREE

Program Overview

Project Managers oversee the planning, implementing, quality control, and status reporting for a given project. Projects exist in all industries including construction, information technology, healthcare and business. Project Managers are needed to manage teams, plan, coordinate, and budget projects from initiation to completion. If you are skilled in a specific industry there are opportunities to use your technical expertise to lead industry-related projects. Construction, IT, Healthcare and Real Estate Project Managers are in especially high demand. Projects can vary greatly in size, specialty and complexity, creating opportunities for Project Managers with varying expertise and experience.

This program provides students with the skills and knowledge to effectively initiate, plan, and implement projects. In addition, the program provides a transferrable skill set in the areas of management, human resources, finance, negotiation, decision making, and leadership.

Career Opportunities

Employment opportunities are very good for skilled, capable, and dependable business professionals. Graduates may choose to continue their education towards a bachelor's degree or begin work in a variety of settings. Possible roles might include: Project Manager, Cost Estimator, Project Coordinator, Project Scheduler, or Assistant Project Manager.

Program Outcomes

1. Graduates will define project management concepts including project, program and portfolio management and its application in today's business world.
2. Graduates will have knowledge in various approaches for selecting projects and programs.
3. Graduates will have knowledge and skills in customer service and demonstrate good oral and written presentation skills.
4. Graduates will apply project management concepts by working on a team project as a project manager or active team member.
5. Graduates will understand the importance of sound business and project management principles.



The mission of the Business Department at Saint Paul College is to sustain the College mission by providing quality, lifelong business education supported by technology for a diverse, metropolitan student population.

Accreditation Council for Business Schools and Programs

Program Faculty

Jon Stambaugh jon.stambaugh@saintpaul.edu
651.846.1592

Program Requirements

Check off when completed

Required Business Core Cr

Professional Component

- ACCT 2410 Financial Accounting 4
- BTEC 1421 Business Info Applications 1 3
- BUSN 1410 Introduction to Business 3
- BUSN 1449 Business Communications 3
- BUSN 2465 Business Ethics 3
- Required Business Core 16**

Course Credits

- BSLM 2420 Supply Chain Management 4
- BSLM 2450 Procurement Principles and Applications 3
- BUSN 1760 Principles of Finance 4
- BUSN 2410 Critical Thinking for Business Decision Making 2
- BUSN 2450 Management Fundamentals 3
- BUSN 2464 Leading and Coaching Others 2
- BUSN 2472 Business Negotiation Skills 3
- BUSN 2473 Project Management 3
- HMRS 1400 Human Resource Management 3
- Subtotal 27**

General Education/MnTC Requirements Cr

Refer to the Minnesota Transfer Curriculum Course List for each Goal Area

- Goal 1: Communication 7
ENGL 1711 Composition 1 – 4 cr
COMM 17XX – 3 cr
- Goal 3 or Goal 4 3
Goal 3: Natural Sciences OR
Goal 4: Mathematical /Logical Reasoning
- Goal 5: History, Social Science, and Behavior Sciences 3
ECON 1720 Macroeconomics – 3 cr OR
ECON 1730 Microeconomics – 3 cr
- Goal 6: Humanities & Fine Arts 3
- Goal 1-10 on the Minnesota Transfer Curriculum . . . 1
- General Education Requirements 17**

Total Program Credits 60

*Information is subject to change.
This Program Requirements Guide is not a contract.*

Program Start Dates

Fall, Spring, Summer

Transfer Opportunities

Saint Paul College has a transfer articulation agreement between the following program and post-secondary institutions for the baccalaureate degree programs listed below.

For more information please go to saintpaul.edu/Transfer.

Project Management AAS

- BA Individualized Studies
Metropolitan State University
- BS Business Administration
Saint Mary's University,
Twin Cities Campus
- BS Project Management
Minnesota State University, Moorhead

Course Sequence

The course sequence listed on the back of this guide is recommended for a full-time student; however, this sequence is not required. Contact Program Faculty with questions.

See back of this guide for Course Sequence

Minimum Program Entry Requirements

Students entering this program must meet the following minimum program entry requirements:

Reading: Score of 78+ or grade of "C" or better in READ 0722

Writing: Score of 78+ or grade of "C" or better in ENGL 0922

Arithmetic: Score of 20+

Assessment Results and Prerequisites:

Students admitted into Saint Paul College programs may need to complete additional courses based on assessment results and course prerequisite requirements. Certain MATH, READ, and ENGL courses have additional prerequisites.

251A (7207)

Project Management AAS DEGREE *(continued)*

Course Sequence

This course sequence is recommended for a full-time student; however, this sequence is not required.

Not all courses are offered each semester; a selection of courses is offered summer term. Students should consult with the Program Faculty each semester.

First Semester

ACCT 2410 Financial Accounting	4
BTEC 1421 Business Info Applications 1.	3
BUSN 1410 Introduction to Business	3
BUSN 1449 Business Communications	3
Goal 1: ENGL 1711 Composition 1.	4
Total Semester Credits.	17

Second Semester

BSLM 2420 Supply Chain Management (spring only)	4
BSLM 2450 Procurement Principles and Applications (spring only)	3
BUSN 2450 Management Fundamentals	3
BUSN 2473 Project Management (spring only)	3
Goal 1: COMM 17XX	3
Total Semester Credits.	16

Third Semester

BUSN 2465 Business Ethics.	3
BUSN 2472 Business Negotiation Skills	3
Goal 5: ECON 1720 Macroeconomics OR ECON 1730 Microeconomics.	3
HMRS 1400 Human Resource Management.	3
Total Semester Credits.	12

Fourth Semester

BUSN 1760 Principles of Finance	4
BUSN 2410 Critical Thinking for Business Decision Making (spring only).	2
BUSN 2464 Leading and Coaching (spring only)	2
Goal 3 or 4: Natural Sciences OR Mathematical/Logical Reasoning	3
Goal 6: Humanities & Fine Arts.	3
Mn Transfer Curriculum.	1
Total Semester Credits.	15

Total Program Credits	60
--	-----------

Project Management CERTIFICATE

Program Overview

Project management is used throughout business to make sure an organization achieves its objectives. A project management certificate prepares students with the tools, skills, and knowledge necessary to initiate, plan, and implement projects successfully. Project planning topics include various types of business projects with special focus on information technology projects to help provide an overview of project management. Techniques such as work breakdown structures, network diagrams, critical path method, earned value analysis, various financial analysis templates and others are covered in the courses.

Career Opportunities

Employment opportunities are very good for skilled, capable, and dependable business professionals. Employers are looking for business professionals with excellent communication skills, organizational skills, human relation skills and enthusiasm for the job and organization. Graduates may choose to continue their education towards a bachelor's degree or begin work in a variety of settings. Graduates can explore opportunities that match their interests and education in a variety of industries.

Program Outcomes

1. Graduates will have the skills, knowledge, and abilities in project management.
2. Graduates will have a basic understanding of project planning.
3. Graduates will have the skills and knowledge necessary to initiate, plan, and implement projects successfully.

Program Faculty

Jon Stambaugh jon.stambaugh@saintpaul.edu
651.846.1592

Part-time/Full-time Options

This program can be completed by using a combination of day, evening, online and Saturday courses. Part-time and full-time options are available.

Program Requirements

Check off when completed

Course	Cr
<input type="checkbox"/> BSLM 2450 Procurement Principles and Applications	3
<input type="checkbox"/> BTEC 1421 Business Information Applications 1	3
<input type="checkbox"/> BUSN 1449 Business Communications	3
<input type="checkbox"/> BUSN 1760 Principles of Finance	4
<input type="checkbox"/> BUSN 2464 Leading and Coaching Others	2
<input type="checkbox"/> BUSN 2472 Business Negotiation Skills	3
<input type="checkbox"/> BUSN 2473 Project Management	3
Total Program Credits	21

Program Start Dates

Fall, Spring, Summer

Course Sequence

The following sequence is recommended; however, this sequence is not required. Contact Program Faculty with questions.

First Semester

BTEC 1421 Business Information Applications	3
BUSN 1449 Business Communications	3
BUSN 2472 Business Negotiation Skills	3
Total Semester Credits	9

Second Semester

BSLM 2450 Procurement Principles and Applications (spring only)	3
BUSN 1760 Principles of Finance	4
BUSN 2464 Leading and Coaching Others (spring only)	2
BUSN 2473 Project Management (spring only)	3
Total Semester Credits	12

Total Program Credits 21

Minimum Program Entry Requirements

Students entering this program must meet the following minimum program entry requirements:

Reading: Score of 38+

Writing: Score of 38+

Arithmetic: Score of 20+

Assessment Results and Prerequisites:

Students admitted into Saint Paul College programs may need to complete additional courses based on assessment results and course prerequisite requirements. Certain MATH, READ, and ENGL courses have additional prerequisites.

Degree option may have a greater requirement than this certificate.

251C (7152)

*Information is subject to change.
This Program Requirements Guide is not a contract.*

Entrepreneurship CERTIFICATE

Program Overview

Many people dream of owning their own business for financial and professional independence as well as the pride of ownership. A certificate in Entrepreneurship can help make that dream become a reality, by providing students with the skills and knowledge necessary to launch a successful business. In this certificate program students will learn how to develop, maintain and grow their own business; explore entrepreneurial concepts and processes that apply to both start-up and well-established enterprises, with an innovative focus and an entrepreneurial spirit. Students will analyze how an organization contributes to society and how entrepreneurship and commercial activities affect the environment. They will also explore topics such as market opportunity, product development, intellectual property and commercialization.

Entrepreneurship and small business plays a key role in the U.S. economy by providing jobs to a large segment of the workforce. Completing this certificate will help the small business entrepreneur maximize the skills and abilities necessary to do business in our challenging environment.

Career Opportunities

Employment opportunities are excellent for starting your own business.

Program Outcomes

1. Graduates will have skills, knowledge and abilities in core business functions, including accounting, marketing and management.
2. Graduates will have an understanding of how to start and market an entrepreneur/small business operation.
3. Graduates will be prepared to manage, market, and enhance an entrepreneurship/ small business operation.
4. Graduates will successfully complete a business plan for their new business.

Program Faculty

Evan Barshack evan.barshack@saintpaul.edu
651.846.1355

Jon Stambaugh jon.stambaugh@saintpaul.edu
651.846.1592

Part-time/Full-time Options

This program can be completed by using a combination of day, evening, Saturday, and online courses. Part-time and full-time options are available.

Program Requirements

Check off when completed

Course	Cr
<input type="checkbox"/> ACCT 1523 Accounting Computer Applications	3
<input type="checkbox"/> BTEC 1421 Business Information Applications 1	3
<input type="checkbox"/> BUSN 1492 Social Media and Marketing	3
<input type="checkbox"/> BUSN 2450 Management Fundamentals	3
<input type="checkbox"/> BUSN 2455 Essentials of Entrepreneurship & Small Business Management	3
<input type="checkbox"/> BUSN 2470 Legal Environment of Business	3
<input type="checkbox"/> BUSN 2472 Business Negotiation Skills	3
<input type="checkbox"/> BUSN 2482 Entrepreneurship Capstone	3
Total Program Credits	24

Program Start Dates

Fall, Spring, Summer

Course Sequence

The following sequence is recommended for a full-time student; however, this sequence is not required. Contact Program Faculty with questions.

First Semester

BTEC 1421 Business Information Applications 1	3
BUSN 2455 Essentials of Entrepreneurship & Small Business Management (fall only)	3
BUSN 2470 Legal Environment of Business	3
BUSN 2472 Business Negotiation Skills	3
Total Semester Credits.	12

Second Semester

ACCT 1523 Accounting Computer Applications	3
BUSN 1492 Social Media and Marketing (spring only)	3
BUSN 2450 Management Fundamentals	3
BUSN 2482 Entrepreneurship Capstone (spring only)	3
Total Semester Credits.	12

Total Program Credits 24

Minimum Program Entry Requirements

Students entering this program must meet the following minimum program entry requirements:

Reading: Score of 38+

Writing: Score of 38+

Arithmetic: Score of 20+

Assessment Results and Prerequisites:

Students admitted into Saint Paul College programs may need to complete additional courses based on assessment results and course prerequisite requirements. Certain MATH, READ, and ENGL courses have additional prerequisites.

253C (7171)

*Information is subject to change.
This Program Requirements Guide is not a contract.*

Finance AS DEGREE

Program Overview

This degree is designed for students to continue their education in finance towards a bachelor's degree at four-year institutions. Students taking this degree would be planning to major in Finance or Accounting. The Finance AS degree prepares students for finance responsibilities. Students learn about the functions of business, including accounting, management, marketing, and human resources. Students study a broad background of finance, business and liberal arts subjects that prepare them for entry-level positions in finance.

Career Opportunities

Employment opportunities are very good for skilled, capable, and dependable finance professionals. Employers are looking for business professionals with excellent communication skills, organizational skills, human relation skills and enthusiasm for the job and organization. Graduates should continue their education towards a bachelor's degree or begin work in a variety of settings. Graduates can explore opportunities that match their interests and education in a variety of industries.

Program Outcomes

1. Graduates will have the skills, knowledge, and abilities in core business functions.
2. Graduates will have a basic understanding of the ethics that impact the business environment.
3. Graduates will be prepared to transfer to another college or university to complete a bachelors program.
4. Graduates will have successfully mastered the general education requirements for work and life roles.

Minimum Program Entry Requirements

Students entering this program must meet the following minimum program entry requirements:

Reading: Score of 78+ or grade of "C" or better in READ 0722

Writing: Score of 78+ on Reading Comprehension or grade of "C" or better in ENGL 0922

College Level Mathematics: Score of 50+ or grade of "C" or better in MATH 0920

Assessment Results and Prerequisites:

Students admitted into Saint Paul College programs may need to complete additional courses based on assessment results and course prerequisite requirements. Certain MATH, READ, and ENGL courses have additional prerequisites.

362S (7209)

Program Faculty

Jim O'Halloran james.o'halloran@saintpaul.edu
651.846.1436

Part-time/Full-time Options

This program can be completed by using a combination of day, evening, Saturday and online courses. Part-time and full-time options are available.

Program Requirements

Check off when completed

Required Business Core Cr

Professional Component

- ACCT 2410 Financial Accounting. 4
- BTEC 1421 Business Information Applications 1 . . . 3
- BUSN 1410 Introduction to Business. 3
- BUSN 1449 Business Communications. 3
- BUSN 2465 Business Ethics 3
- Required Business Core. 16**

Course Cr

- BUSN 1760 Principles of Finance. 4
- BUSN 1762 Money and Banking 4
- BUSN 1782 Investments. 3
- BUSN 1784 Principles of Risk Mgmt. & Insurance . . 3
- Subtotal. 14**

General Education/MnTC Requirements Cr

Refer to the Minnesota Transfer Curriculum Course List for each Goal Area

- Goal 1: Communication 7
ENGL 1711 Composition 1 – 4 cr
COMM 17XX – 3cr
- Goal 3: Natural Sciences 4
BIOL 1725 Environmental Science - 4 cr
- Goal 4: Mathematical/Logical Reasoning. 7
MATH 1730 College Algebra - 3cr
MATH 1740 Introduction to Statistics - 4 cr
- Goal 5: History, Social Science and Behavioral Sciences 6
ECON 1720 Macroeconomics – 3 cr
ECON 1730 Microeconomics – 3 cr
- Goal 6: Humanities and Fine Arts. 3
- Goals 1-10 of the Minnesota Transfer Curriculum . . 3
Select a minimum of 3 additional credits
- General Education Requirements 30**

Total Program Credits 60

*Information is subject to change.
This Program Requirements Guide is not a contract.*

Program Start Dates

Fall, Spring, Summer

Transfer Opportunities

Saint Paul College has a transfer articulation agreement between the following program and post-secondary institutions for the baccalaureate degree programs listed below.

For more information please go to saintpaul.edu/Transfer.

Finance AS

- BA Accounting (Cohort)
Concordia University, St. Paul
- BA Business Management (Traditional)
Concordia University, St. Paul
- BA Individualized Studies
Metropolitan State University
- BS Accounting
Saint Mary's University,
Twin Cities Campus
- BS Business (Cohort)
Concordia University, St. Paul
- BS Business Administration
Saint Mary's University,
Twin Cities Campus
- BS Finance
Metropolitan State University
- BS Finance (Traditional)
Concordia University, St. Paul

Course Sequence

The course sequence listed on the back of this guide is recommended for a full-time student; however, this sequence is not required. Contact Program Faculty with questions.

See back of this guide for Course Sequence



The mission of the Business Department at Saint Paul College is to sustain the College mission by providing quality, lifelong business education supported by technology for a diverse, metropolitan student population.

Accreditation Council for Business Schools and Programs

Finance AS DEGREE *(continued)*

Course Sequence

The following sequence is recommended for a full-time student; however, this sequence is not required. Contact Program Faculty with questions.

First Semester

ACCT 2410 Financial Accounting	4
BTEC 1421 Business Info Applications 1.	3
BUSN 1410 Introduction to Business	3
Goal 1: ENGL 1711 Composition 1.	4
Total Semester Credits.	14

Second Semester

BUSN 1760 Principles of Finance	4
BUSN 2465 Business Ethics.	3
Goal 5: ECON 1720 Macroeconomics	3
Goal 1: COMM 17XX	3
Goal 6: Humanities and Fine Arts	3
Total Semester Credits.	16

Third Semester

BUSN 1449 Business Communications	3
BUSN 1782 Investments	3
BUSN 1784 Principles of Risk Mgmt. & Insurance	3
Goal 4: MATH 1740 Introduction to Statistics	4
Total Semester Credits.	13

Fourth Semester

BUSN 1762 Money and Banking.	4
Goal 3: BIOL 1725 Environmental Sciences	4
Goal 4: MATH 1730 College Algebra	3
Goal 5: ECON 1730 Microeconomics	3
Goal 1-10 General Education Electives.	3
Total Semester Credits.	17

Total Program Credits	60
--	-----------

Global Trade Specialist AAS DEGREE

Program Overview

The global trade area is especially suited for persons who are self-reliant, imaginative, adaptable, and who possess an interest in working with people from other cultures.

Career Opportunities

More than four million people in the United States work in jobs related to global trade. In Minnesota, many businesses engage in global trade, with a dramatic increase in trade activity expected within five years.

A career in global trade offers you the opportunity to work in the global marketplace. The Global Trade Specialist Program will provide you with knowledge and skills that will prepare you for employment in the export and import departments of businesses. You will be working with people from foreign countries, handling foreign orders, filling overseas orders, handling customer matters and determining tariff rates for the entry of foreign goods through U.S. Customs. Job titles include: Global Sales/Marketing Assistant, Global Marketing Communication Coordinator, Global Documentation Specialist, Global Customer Service Coordinator, Export-Import Coordinator, Global Banker and Global Transportation Coordinator.

This program also provides an excellent foundation for individuals wanting to be entrepreneurs in the import/export business. The import/export field is growing! You can grow with it.

Program Outcomes

1. Graduates will have knowledge and skills in domestic and global transportation management and logistics.
2. Graduates will have knowledge of U.S. Custom regulations and classifications.
3. Graduates will demonstrate the ability to successfully perform as Global Trade Specialists via internships.
4. Graduates will be prepared for employment as Global Trade Specialists.
5. Graduates will have knowledge and skills in customer service.
6. Graduates will have critical thinking skills.



The mission of the Business Department at Saint Paul College is to sustain the College mission by providing quality, lifelong business education supported by technology for a diverse, metropolitan student population.

Accreditation Council for Business Schools and Programs

Program Faculty

Jon Stambaugh jon.stambaugh@saintpaul.edu
651.846.1592

Part-time/Full-time Options

This program can be completed by using a combination of day, evening, Saturday and online courses. Part-time and full-time options are available.

Program Requirements

Check off when completed

Required Business Core Cr

Professional Component

- ACCT 2410 Financial Accounting 1 4
- BTEC 1421 Business Information Applications 1 3
- BUSN 1410 Introduction to Business 3
- BUSN 1449 Business Communications 3
- BUSN 2465 Business Ethics 3
- Required Business Core 16**

Course Cr

- BSLM 1410 Transportation Management. 3
- BSLM 1510 Distribution Management 3
- BSLM 2420 Supply Chain Management 4
- BUSN 2472 Business Negotiation 3
- INTL 1400 Introduction to International Business . . 3
- INTL 1410 International Communications and Cultural Awareness. 3
- INTL 1512 Export Shipping and Compliance. 3
- INTL 2420 U.S. Customs and Importing. 3
- INTL 2530 International Marketing 3
- Subtotal 28**

General Education/MnTC Requirements Cr

Refer to the Minnesota Transfer Curriculum Course List for each Goal Area

- Goal 1: Communication 7
ENGL 1711 Composition 1 – 4 cr
COMM 17XX – 3 cr
- Goal 3 or Goal 4 3
Goal 3: Natural Sciences OR
Goal 4: Mathematical/Logical Reasoning
- Goal 5: History, Social Science, and Behavioral Sciences 3
ECON 1720 Macroeconomics – 3 cr OR
ECON 1730 Microeconomics – 3 cr
- Goal 6: Humanities and Fine Arts. 3
- General Education Requirements 16**

Total Program Credits 60

*Information is subject to change.
This Program Requirements Guide is not a contract.*

Program Start Dates

Fall, Spring, Summer

Transfer Opportunities

Saint Paul College has a transfer articulation agreement between the following program and post-secondary institutions for the baccalaureate degree programs listed below.

For more information please go to saintpaul.edu/Transfer.

Global Trade Specialist AAS

- BA Individualized Studies
Metropolitan State University
- BAS International Commerce
Metropolitan State University
- BS Applied Organizational Studies
Minnesota State University, Mankato
- BS Business Administration
Saint Mary's University,
Twin Cities Campus
- BS Project Management
Minnesota State University, Moorhead

Course Sequence

The course sequence listed on the back of this guide is recommended for a full-time student; however, this sequence is not required. Contact Program Faculty with questions.

See back of this guide for Course Sequence

Minimum Program Entry Requirements

Students entering this program must meet the following minimum program entry requirements:

Reading: Score of 78+ or grade of "C" or better in READ 0722

Writing: Score of 78+ or grade of "C" or better in ENGL 0922

Arithmetic: Score of 20+

Assessment Results and Prerequisites: Students admitted into Saint Paul College programs may need to complete additional courses based on assessment results and course prerequisite requirements. Certain MATH, READ, and ENGL courses have additional prerequisites.

333A (7175)

Global Trade Specialist AAS DEGREE *(continued)*

Course Sequence

The following sequence is recommended for a full-time student; however, this sequence is not required. Contact Program Faculty with questions.

First Semester

ACCT 2410 Financial Accounting 1	4
BTEC 1421 Business Info Applications 1.	3
BUSN 1410 Introduction to Business	3
BUSN 1449 Business Communications	3
Goal 1: ENGL 1711 Composition 1.	4
Total Semester Credits.	17

Second Semester

BSLM 2420 Supply Chain Management (spring only)	4
INTL 1400 Introduction to International Business (spring only)	3
INTL 1512 Export Shipping and Compliance (spring only)	3
Goal 1: COMM 17XX	3
Total Semester Credits.	13

Third Semester

BSLM 1410 Transportation Management (fall only)	3
BSLM 1510 Distribution Management (fall only)	3
BUSN 2465 Business Ethics.	3
INTL 1410 International Communications and Cultural Awareness (fall only)	3
INTL 2530 International Marketing (fall only)	3
Total Semester Credits.	15

Fourth Semester

BUSN 2472 Business Negotiation Skills	3
INTL 2420 U.S. Customs and Importing (spring only)	3
Goal 3 or 4: Natural Sciences OR Mathematical/Logical Reasoning	3
Goal 5: ECON 1720 Macroeconomics OR ECON 1730 Microeconomics.	3
Goal 6: Humanities and Fine Arts	3
Total Semester Credits.	15

Total Program Credits	60
--	-----------

Global Trade Professional CERTIFICATE

Program Overview

This certificate is transferable to the Global Trade Specialist AAS program.

This certificate program is designed for an individual who is currently working in the Global Trade/Logistics field, or has a prior degree. It is not for entry level to the global trade field, but is designed as an add-on certificate to enhance and build on prior knowledge.

Career Opportunities

More than four million people in the United States work in jobs related to global trade. In Minnesota, many businesses engage in global trade, with a dramatic increase in trade activity expected within five years.

A career in global trade offers you the opportunity to work in the global marketplace. The Global Trade Specialist Program will provide you with knowledge and skills that will prepare you for employment in the export and import departments of businesses. You will be working with people from foreign countries, handling foreign orders, filling overseas orders, handling customer matters and determining tariff rates for the entry of foreign goods through U.S. Customs. Job titles include: Global Sales/Marketing Assistant, Global Marketing Communication Coordinator, Global Documentation Specialist, Global Customer Service Coordinator, Export-Import Coordinator, Global Banker and Global Transportation Coordinator.

This program also provides an excellent foundation for individuals wanting to be entrepreneurs in the import/export business. The import/export field is growing! You can grow with it.

Program Outcomes

1. Graduates will have knowledge and skills in domestic and global transportation management and logistics.
2. Graduates will have knowledge of U.S. Custom regulations and classifications.
3. Graduates will demonstrate the ability to successfully perform as Global Trade Specialists via internships.
4. Graduates will be prepared for employment as Global Trade Specialists.
5. Graduates will have knowledge and skills in customer service.

Program Faculty

Jon Stambaugh jon.stambaugh@saintpaul.edu
651.846.1592

Part-time/Full-time Options

This program can be completed by using a combination of day, evening, Saturday and online courses. Part-time and full-time options are available.

Admission Requirements

Applicants are required to have a high school diploma or equivalent.

The global trade area is especially suited for persons who are self-reliant, imaginative, adaptable, and who possess an interest in working with people from other cultures.

Program Requirements

Check off when completed

This certificate program is designed for an individual who is currently working in the International Trade/Logistics field, or has a prior degree. It is not for entry level to the international trade field, but is designed as an add-on certificate to enhance and build on prior knowledge.

Program Faculty approval is required.

Course	Cr
<input type="checkbox"/> BSLM 2420 Supply Chain Management	4
<input type="checkbox"/> INTL 1410 International Communication and Cultural Awareness	3
<input type="checkbox"/> INTL 1512 Export Shipping and Compliance	3
<input type="checkbox"/> INTL 2420 U. S. Customs and Importing	3
<input type="checkbox"/> INTL 2530 International Marketing	3

Total Program Credits 16

Program Start Dates

Fall, Spring

Course Sequence

The following sequence is recommended; however, this sequence is not required. Contact Program Faculty with questions.

First Semester

INTL 1410 International Communication and Cultural Awareness (fall only)	3
INTL 2530 International Marketing (fall only)	3
Total Semester Credits	6

Second Semester

BSLM 2420 Supply Chain Management (spring only)	4
INTL 1512 Export Shipping and Compliance (spring only)	3
INTL 2420 U. S. Customs and Importing (spring only)	3
Total Semester Credits	10

Total Program Credits 16

Minimum Program Entry Requirements

Contact Faculty Jon Stambaugh, at 651.846.1592 or jon.stambaugh@saintpaul.edu.

Students entering this program must meet the following minimum program entry requirements:

Reading: Score of 38+

Writing: Score of 38+

Arithmetic: Score of 20+

Assessment Results and Prerequisites: Students admitted into Saint Paul College programs may need to complete additional courses based on assessment results and course prerequisite requirements. Certain MATH, READ, and ENGL courses have additional prerequisites.

Degree option may have a greater requirement than this certificate.

333C (7174)

*Information is subject to change.
This Program Requirements Guide is not a contract.*

Hospitality Management AAS DEGREE

Program Overview

The Hospitality Management curriculum focuses on the management of today's exciting hospitality and entertainment industries. Students will receive a solid foundation of business practices related to this growing service industry. Courses will examine organizations and careers in lodging, tourism, sports, entertainment, event and meeting management.

Career Opportunities

According to the Minnesota Department of Revenue and the Minnesota Department of Employment and Economic Development, there are 245,000 full and part-time jobs, and 4.3 billion dollars in wages in the Leisure and Hospitality sector.

Employment opportunities including hotel/lodging operations, restaurant and catering management, travel and tourism, sports, recreation and facilities management, gaming and casino operations, meeting, convention and special event management.

The hospitality industry provides ample opportunity for students to gain management experience. In a very short number of years after graduation, a student could be a manager of a multi-million dollar business/hospitality operation. The skills, experience and abilities gained in hospitality are transferable to other businesses and industries. With a Hospitality Management AAS degree students differentiate themselves from other candidates when applying for positions.

Program Outcomes

1. Graduates will demonstrate successful management concepts and practices in Hospitality.
2. Graduates will discover the interrelated nature of Hospitality Travel, Entertainment, Recreation and Tourism.
3. Graduates will develop customer service, service spirit and communication skills.
4. Graduates will demonstrate problem solving skills and integrate new ways of thinking and learning.

Program Faculty

Craig Maus craig.maus@saintpaul.edu
651.846.1531

Program Requirements

Check off when completed

Required Business Core Cr

Professional Component	
<input type="checkbox"/> ACCT 2410 Financial Accounting.	4
<input type="checkbox"/> BTEC 1421 Business Information Applications 1	3
<input type="checkbox"/> BUSN 1410 Introduction to Business	3
<input type="checkbox"/> BUSN 1449 Business Communications.	3
<input type="checkbox"/> BUSN 2465 Business Ethics	3
Required Business Core.	16

Course Cr

<input type="checkbox"/> BUSN 1441 Consumer Behavior.	3
<input type="checkbox"/> BUSN 1446 Sales and Account Management	3
<input type="checkbox"/> BUSN 1480 Business Career Resources	1
<input type="checkbox"/> BUSN 2110 Principles of Marketing.	3
<input type="checkbox"/> BUSN 2450 Management Fundamentals.	3
<input type="checkbox"/> BUSN 2472 Business Negotiation Skills	3
<input type="checkbox"/> HSPM 1410 Introduction to Hospitality Management	3
<input type="checkbox"/> HSPM 1440 Event Management and Planning	3
<input type="checkbox"/> HSPM 2420 Hotel and Lodging Operations	3
<input type="checkbox"/> HSPM 2440 Hospitality Marketing and Sales.	3
Subtotal.	28

General Education/MnTC Requirements Cr

Refer to the Minnesota Transfer Curriculum Course List for each Goal Area

<input type="checkbox"/> Goal 1: Communication	7
ENGL 1711 Composition 1 – 4 cr	
COMM 17XX – 3 cr	
<input type="checkbox"/> Goal 3 or Goal 4	3
Goal 3: Natural Sciences OR	
Goal 4: Mathematical/Logical Reasoning	
<input type="checkbox"/> Goal 5: History, Social Science, and Behavioral Sciences	3
ECON 1720 Macroeconomics – 3 cr OR	
ECON 1730 Microeconomics – 3 cr	
<input type="checkbox"/> Goal 6: Humanities and Fine Arts	3
General Education Requirements	16

Total Program Credits 60

Program Start Dates

Fall, Spring, Summer

Course Sequence

The course sequence listed on the back of this guide is recommended for a full-time student; however, this sequence is not required. Contact Program Faculty with questions.

The following courses are not offered every semester.

Fall Semester Only

The following courses are offered fall semester only.
 BUSN 1441 Consumer Behavior
 HSPM 1410 Introduction to Hospitality Management
 HSPM 2420 Hotel and Lodging Operations
 HSPM 2440 Hospitality Marketing and Sales

Spring Semester Only

The following courses are offered spring semester only.
 BUSN 1446 Sales and Account Management
 HSPM 1440 Event Management and Planning

All other courses are offered both fall and spring semester.

See back of this guide for Course Sequence



The mission of the Business Department at Saint Paul College is to sustain the College mission by providing quality, lifelong business education supported by technology for a diverse, metropolitan student population.

Information is subject to change. This Program Requirements Guide is not a contract.

Minimum Program Entry Requirements

Students entering this program must meet the following minimum program entry requirements:

Reading: Score of 78+ or grade of "C" or better in READ 0722

Writing: Score of 78+ or grade of "C" or better in ENGL 0922

Arithmetic: Score of 20+

Assessment Results and Prerequisites: Students admitted into Saint Paul College programs may need to complete additional courses based on assessment results and course prerequisite requirements. Certain MATH, READ, and ENGL courses have additional prerequisites.

300A (7130)

Hospitality Management AAS DEGREE *(continued)*

Course Sequence

The following sequence is recommended for a full-time student; however, this sequence is not required. Contact Program Faculty with questions.

First Semester

ACCT 2410 Financial Accounting	4
BTEC 1421 Business Info Applications 1.	3
BUSN 1410 Introduction to Business	3
HSPM 1410 Introduction to Hospitality Management (fall only)	3
Goal 1: ENGL 1711 Composition 1.	4
Total Semester Credits	17

Second Semester

BUSN 1480 Business Career Resources.	1
BUSN 2110 Principles of Marketing	3
BUSN 2450 Management Fundamentals	3
HSPM 1440 Event Management and Planning (spring only)	3
Goal 1: COMM 17XX	3
Total Semester Credits	13

Third Semester

BUSN 1441 Consumer Behavior (fall only)	3
BUSN 2472 Business Negotiation Skills	3
HSPM 2420 Hotel and Lodging Operations (fall only)	3
HSPM 2440 Hospitality Marketing and Sales (fall only)	3
Goal 5: ECON 1720 Macroeconomics OR ECON 1730 Microeconomics	3
Total Semester Credits	15

Fourth Semester

BUSN 1446 Sales and Account Management (spring only)	3
BUSN 1449 Business Communications	3
BUSN 2465 Business Ethics.	3
Mn Transfer Curriculum.	6
Total Semester Credits	15

Total Program Credits	60
--	-----------

Transfer Opportunities

Saint Paul College has a transfer articulation agreement between the following program and post-secondary institutions for the baccalaureate degree programs listed below.

For more information please go to saintpaul.edu/Transfer.

Hospitality Management AAS

BA	Individualized Studies Metropolitan State University
BA	Travel and Tourism Cloud State University
BS	Marketing Saint Mary's University, Twin Cities Campus
BS	Project Management Minnesota State University, Moorhead

Event and Meeting Management CERTIFICATE

Program Overview

The Event and Meeting Management curriculum focuses on the management of special events planning, organizing activities and timelines, operational effectiveness and customer satisfaction. Students will receive a solid foundation of business practices related to this growing service industry.

This certificate is intended for those seeking to expand their career paths with the skills necessary to plan unique and effective events and meetings.

Career Opportunities

According to the Minnesota Department of Revenue and the Minnesota Department of Employment and Economic Development, there are 245,000 full and part-time jobs, and 4.3 billion dollars in wages in the Leisure and Hospitality sector.

There are a wide variety of employment opportunities including hotel/ lodging operations, restaurant and catering management, travel and tourism, sports, recreation and facilities management, gaming and casino operations, meeting, convention and special event management.

According to the U.S. Bureau of Labor Statistics, the occupational outlook for meeting, convention and event planners is projected to grow 11% from 2016 – 2026.

Program Outcomes

1. Graduates will have knowledge of the meeting and special event industry.
2. Graduates will develop customer service, human relations and communications skills.
3. Graduates will have knowledge and skills to plan, manage and promote meeting and special events.

Program Faculty

Craig Maus craig.maus@saintpaul.edu
651.846.1531

Part-time/Full-time Options

This program can be completed by using a combination of day, evening, and Web-enhanced courses. Part-time and full-time options are available.

Program Requirements

Check off when completed

Course	Cr
<input type="checkbox"/> BUSN 2110 Principles of Marketing	3
<input type="checkbox"/> BUSN 2450 Management Fundamentals	3
<input type="checkbox"/> BUSN 2455 Essentials of Entrepreneurship & Small Business Management	3
<input type="checkbox"/> HSPM 1410 Introduction to Hospitality Management	3
<input type="checkbox"/> HSPM 1440 Event Management and Planning	3
<input type="checkbox"/> HSPM 2440 Hospitality Marketing and Sales	3
Total Program Credits	18

Program Start Dates

Fall, Spring

Course Sequence

The following sequence is recommended; however, this sequence is not required. Contact Program Faculty with questions.

First Semester

BUSN 2455 Essentials of Entrepreneurship & Small Business Management	3
HSPM 1410 Introduction to Hospitality Management (fall only)	3
HSPM 2440 Hospitality Marketing and Sales (fall only)	3
Total Semester Credits	9

Second Semester

BUSN 2110 Principles of Marketing	3
BUSN 2450 Management Fundamentals	3
HSPM 1440 Event Management and Planning (spring only)	3
Total Semester Credits	9
Total Program Credits	18

*Information is subject to change.
This Program Requirements Guide is not a contract.*

Minimum Program Entry Requirements

Students entering this program must meet the following minimum program entry requirements in addition to having acquired previous technical computer skills:

Reading: Score of 38+

Writing: Score of 38+

Arithmetic: Score of 20+

Degree option may have a greater requirement than this certificate.

332C (7173)

Human Resources AAS DEGREE

Program Overview

The Human Resources Associate of Applied Science Degree is intended for students who desire immediate employment upon graduation, or who plan to transfer to another institution of higher education.

The human resource professional plays a strategic role in the success of the organization. A human resource professional needs to be competent in human resource knowledge, able to facilitate change, have personal credibility which includes trust and confidentiality and the understanding of how a business operates. Specific duties may involve facilitating employee communication, managing human resource record keeping, administering employee compensation and benefit plans, recruiting, hiring and orienting new employees, writing policies and applying federal, state and local employment laws and regulations.

Qualifications include excellent communication and human relation skills, computer skills, flexibility and the ability to work under pressure.

Career Opportunities

Employment opportunities are strong for skilled, capable, and dependable Human Resource program graduates. Human Resource program graduates may be employed in positions such as: Human Resource Representative, Human Resource Coordinator, HR Assistant, Human Resource Specialist, Human Resource Generalist, Compensation or Benefits Specialist, Staffing Coordinator, Employment Specialist, Payroll Specialist, or Training and Development Assistant.

Program Outcomes

1. Graduates will have the skills, knowledge and abilities in core human resource functions (e.g., HRIS, record keeping, compensation/benefits administration and staffing procedures).
2. Graduates will have the skills, knowledge, and abilities to identify and deal with employee relation issues and to communicate effectively in a work environment.
3. Graduates will have the skills, knowledge, and abilities in applicable federal, state, and local employment regulations and a working knowledge of basic employment laws.
4. Graduates will be prepared for employment in the field of human resources (in a variety of positions).
5. Graduates will have successfully mastered the general education requirements for work and life roles.

Program Faculty

Mindy Travers mindy.travers@saintpaul.edu
651.846.1526

Part-time/Full-time Options

This program can be completed by using a combination of day, evening, and online courses. Part time and full time options are available.

Program Requirements

Check off when completed

Required Business Core	Cr
Professional Component	
<input type="checkbox"/> ACCT 2410 Financial Accounting	4
<input type="checkbox"/> BTEC 1421 Business Information Applications 1 . . .	3
<input type="checkbox"/> BUSN 1410 Introduction to Business	3
<input type="checkbox"/> BUSN 1449 Business Communications	3
<input type="checkbox"/> BUSN 2465 Business Ethics	3
Required Business Core	16

Course	Cr
<input type="checkbox"/> ACCT 1515 Payroll Processing	3
<input type="checkbox"/> BUSN 1480 Business Career Resources	1
<input type="checkbox"/> BUSN 2464 Leading and Coaching Others	2
<input type="checkbox"/> BUSN 2466 Managing Change and Conflict	2
<input type="checkbox"/> HMRS 1400 Human Resource Management	3
<input type="checkbox"/> HMRS 1490 Talent Management	3
<input type="checkbox"/> HMRS 1510 HR Information Systems & Records . . .	3
<input type="checkbox"/> HMRS 1520 Compensation & Benefits Administration	3
<input type="checkbox"/> HMRS 2410 Employee/Labor Relations	3
<input type="checkbox"/> HMRS 2420 Employment Law & HR Policies	3
Subtotal	26

General Education/MnTC Requirements	Cr
Refer to the Minnesota Transfer Curriculum Course List for each Goal Area	
<input type="checkbox"/> Goal 1: Communication	7
ENGL 1711 Composition 1 – 4 cr	
COMM 17XX – 3 cr	
<input type="checkbox"/> Goal 3 or Goal 4	3
Goal 3: Natural Sciences OR	
Goal 4: Mathematical/Logical Reasoning	
<input type="checkbox"/> Goal 5: History, Social Science, and Behavioral Sciences	3
ECON 1720 Macroeconomics – 3 cr OR	
ECON 1730 Microeconomics – 3 cr	
<input type="checkbox"/> Goal 6: Humanities and Fine Arts	3
<input type="checkbox"/> Goals 1-10 of the Minnesota Transfer Curriculum . . .	2
General Education Requirements	18

Total Program Credits 60

*Information is subject to change.
This Program Requirements Guide is not a contract.*

Program Start Dates

Fall, Spring, Summer

Transfer Opportunities

Saint Paul College has a transfer articulation agreement between the following program and post-secondary institutions for the baccalaureate degree programs listed below.

For more information please go to saintpaul.edu/Transfer.

Human Resources AAS

BA	Business	Bethel University
BA	Individualized Studies	Metropolitan State University
BS	Applied Organizational Studies	Minnesota State University, Mankato
BS	Human Resource Management	Saint Mary's University, Twin Cities Campus
BS	Project Management	Minnesota State University, Moorhead

Course Sequence

The course sequence listed on the back side of this guide is recommended for a full-time student; however, this sequence is not required. Contact Program Faculty with questions.

The following courses are not offered every semester:

- BUSN 2464 Leading and Coaching Others
- BUSN 2466 Managing Change and Conflict
- HMRS 1490 Talent Management
- HMRS 1510 HR Information Systems & Records
- HMRS 1520 Compensation & Benefits Administration
- HMRS 2410 Employee/Labor Relations
- HMRS 2420 Employment Law & HR Policies

See back of this guide for Course Sequence

Minimum Program Entry Requirements

Students entering this program must meet the following minimum program entry requirements:

Reading: Score of 78+ or grade of "C" or better in READ 0722

Writing: Score of 78+ or grade of "C" or better in ENGL 0922

Arithmetic: Score of 20+

Assessment Results and Prerequisites: Students admitted into Saint Paul College programs may need to complete additional courses based on assessment results and course prerequisite requirements. Certain MATH, READ, and ENGL courses have additional prerequisites.

015A (7027)

Human Resources AAS DEGREE *(continued)*

Course Sequence

The following sequence is recommended for a full-time student; however, this sequence is not required. Please be aware that most HMRS courses run once per academic year. Contact Program Faculty with questions.

First Semester

BUSN 1410 Introduction to Business	3
BUSN 1449 Business Communications	3
BTEC 1421 Business Info Applications 1	3
HMRS 1400 Human Resource Management	3
Goal 1: ENGL 1711 Composition 1	4
Total Semester Credits	16

Second Semester

ACCT 1515 Payroll Processing	3
BUSN 1480 Business Career Resources	1
BUSN 2464 Leading and Coaching Others (spring only)	2
BUSN 2466 Managing Conflict & Change (spring only)	2
HMRS 1490 Talent Management (spring only)	3
Goal 1: COMM 17XX	3
Total Semester Credits	14

Third Semester

BUSN 2465 Business Ethics	3
Goal 5: ECON 1720 Macroeconomics OR ECON 1730 Microeconomics	3
HMRS 1510 HR Information Systems & Records (fall only)	3
HMRS 1520 Compensation & Benefits Administration (fall only)	3
HMRS 2410 Employee/Labor Relations (fall only)	3
Total Semester Credits	15

Fourth Semester

ACCT 2410 Financial Accounting	4
HMRS 2420 Employment Law & HR Policies (spring only)	3
Goal 3 or 4: Natural Sciences OR Mathematical/Logical Reasoning	3
Goal 6: Humanities and Fine Arts	3
Mn Transfer Curriculum	2
Total Semester Credits	15

Total Program Credits60



The mission of the Business Department at Saint Paul College is to sustain the College mission by providing quality, lifelong business education supported by technology for a diverse, metropolitan student population.

Accreditation Council for Business Schools and Programs

Human Resources CERTIFICATE

Program Overview

This program is designed for an individual who desires to enter the Human Resources field with a general grounding in Human Resources within a short period of time. The certificate program is transferable to the Human Resources AAS program.

Career Opportunities

Employment opportunities are strong for skilled, capable, and dependable Human Resource program graduates.

Human Resource program graduates may be employed in positions such as: Human Resource Representative, Human Resource Coordinator, HR Assistant, Human Resource Specialist, Staffing Coordinator, Payroll Specialist, or Training and Development Assistant.

Program Outcomes

1. Graduates will have the skills, knowledge, and abilities in core human resource functions (e.g., HRIS, Record Keeping, Compensation/ Benefits Administration, and staffing procedures).
2. Graduates will have the skills, knowledge, and abilities to identify and deal with employee relation issues and to communicate effectively in a work environment.
3. Graduates will have the skills, knowledge, and abilities in applicable federal, state, and local employment regulations and a working knowledge of basic employment laws.
4. Graduates will be prepared for entry level employment in the field of human resources (in a variety of positions).

Program Faculty

Mindy Travers mindy.travers@saintpaul.edu
651.846.1526

Program Requirements

Check off when completed

Course	Cr
<input type="checkbox"/> ACCT 1515 Payroll Processing	3
<input type="checkbox"/> BUSN 2464 Leading and Coaching Others	2
<input type="checkbox"/> BUSN 2466 Managing Change and Conflict	2
<input type="checkbox"/> HMRS 1400 Human Resources Management	3
<input type="checkbox"/> HMRS 1490 Talent Management	3
<input type="checkbox"/> HMRS 1510 HR Information Systems & Records	3
<input type="checkbox"/> HMRS 1520 Compensation & Benefits Admin.	3
<input type="checkbox"/> HMRS 2410 Employee/Labor Relations	3
<input type="checkbox"/> HMRS 2420 Employment Law & HR Policies	3
Subtotal	25

Total Program Credits 25

Program Start Dates

Fall, Spring

Course Sequence

The following sequence is recommended for a full-time student; however, this sequence is not required. Please be aware that most HMRS courses run once per academic year. Contact Program Faculty with questions.

First Semester

HMRS 1400 Human Resource Management	3
HMRS 1510 HR Information Systems & Records (fall only)	3
HMRS 1520 Compensation & Benefits Administration (fall only)	3
HMRS 2410 Employee/Labor Relations (fall only)	3
Total Semester Credits	12

Second Semester

ACCT 1515 Payroll Processing	3
BUSN 2464 Leading and Coaching Others (spring only)	2
BUSN 2466 Managing Conflict & Change (spring only)	2
HMRS 1490 Talent Management (spring only)	3
HMRS 2420 Employment Law & HR Policies (spring only)	3
Total Semester Credits	13

Total Program Credits 25

Minimum Program Entry Requirements

Students entering this program must meet the following minimum program entry requirements:

Reading: Score of 78+ or grade of "C" or better in READ 0722

Arithmetic: Score of 20+

Assessment Results and Prerequisites: Students admitted into Saint Paul College programs may need to complete additional courses based on assessment results and course prerequisite requirements. Certain MATH, READ, and ENGL courses have additional prerequisites.

Degree option may have a greater requirement than this certificate.

014C (7026)

*Information is subject to change.
This Program Requirements Guide is not a contract.*

Marketing AAS DEGREE

Program Overview

This program provides students with the fundamentals of marketing and business management. Practices and concepts will be explored relating to sales, promotions, public relations, retail sales and event planning. Students will develop marketing and communication plans that create value and develop long term customer relationships.

Career Opportunities

According to the U.S. Bureau of Labor Statistics, U.S. Department of Labor, Occupational Outlook Handbook, marketing, sales, and customer service positions are projected to grow 5% from 2016-2026.

Program Outcomes

1. Graduates will have skills, knowledge and abilities in core business functions including accounting, marketing and management.
2. Graduates will have an understanding of how to market products and services and deliver customer value.
3. Graduates will have knowledge and skills to attract new customers and retain existing customers.
4. Graduates will demonstrate problem solving skills and integrate new ways of thinking and learning.

Transfer Opportunities

Saint Paul College has a transfer articulation agreement between the following program and post-secondary institutions for the baccalaureate degree programs listed below.

For more information please go to saintpaul.edu/Transfer.

Marketing AAS

- BA Individualized Studies
Metropolitan State University
- BS Marketing
Saint Mary's University,
Twin Cities Campus
- BS Sales & Marketing
Saint Mary's University,
Twin Cities Campus



The mission of the Business Department at Saint Paul College is to sustain the College mission by providing quality, lifelong business education supported by technology for a diverse, metropolitan student population.

Accreditation Council for Business Schools and Programs

Program Faculty

Craig Maus craig.maus@saintpaul.edu
651.846.1531

Part-time/Full-time Options

This program can be completed by using a combination of day, evening, Saturday, and online courses. Part-time and full-time options are available.

Program Requirements

Check off when completed

Required Business Core Cr

- Professional Component**
- ACCT 2410 Financial Accounting. 4
 - BTEC 1421 Business Information Applications 1 . . . 3
 - BUSN 1410 Introduction to Business 3
 - BUSN 1449 Business Communications 3
 - BUSN 2465 Business Ethics 3
 - Required Business Core 16**

Course Cr

- BUSN 1441 Consumer Behavior. 3
- BUSN 1444 Advertising and Promotional Strategies. 3
- BUSN 1446 Sales and Account Management 3
- BUSN 1480 Business Career Resources 1
- BUSN 1490 E-Marketing 3
- BUSN 1492 Social Media Marketing 3
- BUSN 2110 Principles of Marketing. 3
- BUSN 2450 Management Fundamentals. 3
- BUSN 2472 Business Negotiation Skills 3
- HSPM 1440 Event Management and Planning . . . 3
- Subtotal. 28**

General Education/MnTC Requirements Cr

Refer to the Minnesota Transfer Curriculum Course List for each Goal Area

- Goal 1: Communication 7
ENGL 1711 Composition 1 – 4 cr
COMM 17XX – 3 cr
- Goal 3 or Goal 4 3
Goal 3: Natural Sciences OR
Goal 4: Mathematical/Logical Reasoning
- Goal 5: History, Social Science, and Behavioral Sciences 3
ECON 1720 Macroeconomics – 3 cr OR
ECON 1730 Microeconomics – 3 cr
- Goal 6: Humanities and Fine Arts. 3
- General Education Requirements 16**

Total Program Credits 60

*Information is subject to change.
This Program Requirements Guide is not a contract.*

Program Start Dates

Fall, Spring, Summer

Course Sequence

The course sequence listed on the back side of this guide is recommended for a full-time student; however, this sequence is not required. Contact Program Faculty with questions.

The following courses are not offered every semester.

Fall Semester Only

The following courses are offered fall semester only.
BUSN 1441 Consumer Behavior
BUSN 1490 E-Marketing

Spring Semester Only

The following courses are offered spring semester only.
BUSN 1444 Advertising and Promotion Strategies
BUSN 1446 Sales and Account Management
BUSN 1492 Social Media Marketing
HSPM 1440 Event Management and Planning

All other courses are offered both fall and spring semester.

See back of this guide for Course Sequence

Minimum Program Entry Requirements

Students entering this program must meet the following minimum program entry requirements:

Reading: Score of 78+ or grade of "C" or better in READ 0722

Writing: Score of 78+ or grade of "C" or better in ENGL 0922

Arithmetic: Score of 20+

Assessment Results and Prerequisites:

Students admitted into Saint Paul College programs may need to complete additional courses based on assessment results and course prerequisite requirements. Certain MATH, READ, and ENGL courses have additional prerequisites.

302A (7157)

Marketing AAS DEGREE *(continued)*

Course Sequence

The following sequence is recommended for a full-time student; however, this sequence is not required. Contact Program Faculty with questions.

First Semester

ACCT 2410 Financial Accounting4
 BTEC 1421 Business Info Applications 1.3
 BUSN 1410 Introduction to Business3
 BUSN 2110 Principles of Marketing3
 Goal 1: ENGL 1711 Composition 1.4
Total Semester Credits. 17

Second Semester

BUSN 1444 Advertising and Promotional Strategies
 (spring only)3
 BUSN 1449 Business Communications3
 HSPM 1440 Event Management and Planning
 (spring only)3
 BUSN 1446 Sales and Account Management
 (spring only)3
 Goal 1: COMM 17XX3
Total Semester Credits. 15

Third Semester

BUSN 1441 Consumer Behavior
 (fall only)3
 BUSN 1490 E-Marketing
 (fall only)3
 BUSN 2450 Management Fundamentals3
 Goal 5: ECON 1720 Macroeconomics OR
 ECON 1730 Microeconomics3
Total Semester Credits. 12

Fourth Semester

BUSN 1480 Business Career Resources1
 BUSN 2465 Business Ethics.3
 BUSN 2472 Business Negotiation Skills3
 BUSN 1492 Social Media Marketing
 (spring only)3
 Goal 3 or 4: Natural Sciences OR
 Mathematical/Logical Reasoning3
 Goal 6: Humanities and Fine Arts3
Total Semester Credits. 16

Total Program Credits60

Social Media Marketing CERTIFICATE

Program Overview

Facebook, Twitter, YouTube and other social media platforms are opportunities for organizations to inform, communicate and connect with customers. Social media provides both a listening and outreach tool for promoting organizations, products, services and ideas. This program provides a foundation of social media and Internet marketing. Students will learn and analyze techniques, tactics and tools used to engage customers and deliver superior value. Jobs and careers in this fast changing field of marketing will be explored.

Career Opportunities

All organizations, including for-profit business or non-profit organizations, have the need for communicating with customers and stakeholders. This program is designed for those who want to expand their knowledge and skills of social media and internet marketing strategies. Many employers require some education or experience in marketing even for “non-marketing” positions. Employment opportunities are excellent for marketers who can engage, delight and develop meaningful relationships with customers. Opportunities and positions include marketing specialist, marketing research analyst, and customer service representative.

Program Outcomes

1. Develop an understanding of social media and e-marketing and the fundamental shifts on how organizations communicate with its customers.
2. Students will have skills and abilities to analyze internet marketing and communications strategies to serve and deliver value that attract new customers and develop relationships with existing customers.
3. Create e-marketing and social media marketing plans that are integrated with an organization’s overall marketing strategy and goals.

Program Faculty

Craig Maus craig.maus@saintpaul.edu
651.846.1531

Part-time/Full-time Options

This program can be completed by using a combination of day, evening, Saturday and online courses. Part-time and full-time options are available.

Program Requirements

Check off when completed

Course	Cr
<input type="checkbox"/> BUSN 1441 Consumer Behavior	3
<input type="checkbox"/> BUSN 1444 Advertising and Promotional Strategies	3
<input type="checkbox"/> BUSN 1490 E-Marketing	3
<input type="checkbox"/> BUSN 1492 Social Media Marketing	3
<input type="checkbox"/> BUSN 2110 Principles of Marketing	3
<input type="checkbox"/> DGIM 1540 Blogging Applications	2
Total Program Credits	17

Program Start Dates

Fall, Spring

Course Sequence

The following sequence is recommended; however, this sequence is not required. Contact Program Faculty with questions.

First Semester

BUSN 1441 Consumer Behavior (fall only)	3
BUSN 1490 E-Marketing (fall only)	3
BUSN 2110 Principles of Marketing	3
Total Semester Credits	9

Second Semester

BUSN 1444 Advertising and Promotional Strategies (spring only)	3
BUSN 1492 Social Media Marketing (spring only)	3
DGIM 1540 Blogging Applications (spring only)	2
Total Semester Credits	8

Total Program Credits 17

Minimum Program Entry Requirements

Students entering this program must meet the following minimum program entry requirements:

Reading: Score of 38+

Writing: Score of 38+

Arithmetic: Score of 20+

Assessment Results and Prerequisites:

Students admitted into Saint Paul College programs may need to complete additional courses based on assessment results and course prerequisite requirements. Certain MATH, READ, and ENGL courses have additional prerequisites.

Degree option may have a greater requirement than this certificate.

338C

*Information is subject to change.
This Program Requirements Guide is not a contract.*

Supply Chain Logistics AAS DEGREE

Program Overview

Logistics management is concerned with the procurement, movement, storage and processing of materials and information across the whole of the supply chain, from acquisition of raw materials and components, through manufacturing, to delivery of finished products to end users.

This program provides students the opportunity to understand modern supply chain management. Supply Chain management demands a multidisciplinary and cross-functional approach to business that transcends the traditional functional boundaries and management disciplines that characterize many organizations.

Career Opportunities

Supply Chain Logistics offers a wide variety of employment opportunities. Some of these are purchasing and supplier management, manufacturing logistics, inventory management, transport management, distribution, warehousing management, customer service management, information management and logistics and supply chain strategy. Because of the wide range of jobs open to graduates, prospective students are asked to consult with the program instructor for specific job forecasts.

Program Outcomes

1. Graduates will have knowledge and skills in distribution, transportation management, logistics, and purchasing.
2. Graduates will have knowledge and skills in customer service.
3. Graduates will be prepared for positions in transportation, distribution, and supply chain management.
4. Graduates will have knowledge and skills to provide foresight of potential opportunities in the management of supply chain.
5. Graduates will have critical thinking skills.



The mission of the Business Department at Saint Paul College is to sustain the College mission by providing quality, lifelong business education supported by technology for a diverse, metropolitan student population.

Accreditation Council for Business Schools and Programs

Information is subject to change.
This Program Requirements Guide is not a contract.

Program Faculty

Jon Stambaugh jon.stambaugh@saintpaul.edu
651.846.1592

Part-time/Full-time Options

This program can be completed by using a combination of day, evening, Saturday and online courses. Part-time and full-time options are available.

Program Requirements

Check off when completed

Required Business Core Cr

Professional Component

- ACCT 2410 Financial Accounting 4
- BTEC 1421 Business Information Applications 1 . . . 3
- BUSN 1410 Introduction to Business 3
- BUSN 1449 Business Communications 3
- BUSN 2465 Business Ethics 3
- Required Business Core 16**

Course Cr

- BSLM 1410 Transportation Management 3
- BSLM 1510 Distribution Management 3
- BSLM 2420 Supply Chain Management 4
- BSLM 2450 Procurement Principles and Applications 3
- BUSN 2110 Principles of Marketing 3
- BUSN 2472 Business Negotiation Skills 3
- INTL 1512 Export Shipping and Compliance 3
- INTL 2420 U. S. Customs and Importing 3
- Business Elective 2
- Subtotal 27**

General Education/MnTC Requirements Cr

Refer to the Minnesota Transfer Curriculum Course List for each Goal Area

- Goal 1: Communication 7
ENGL 1711 Composition 1 – 4 cr
COMM 17XX – 3 cr
- Goal 3 or Goal 4 3
Goal 3: Natural Sciences OR
Goal 4: Mathematical/Logical Reasoning
- Goal 5: History, Social Science, and Behavioral Sciences 3
ECON 1720 Macroeconomics – 3 cr OR
ECON 1730 Microeconomics – 3 cr
- Goal 6: Humanities and Fine Arts 3
- Goals 1-10 of the Minnesota Transfer Curriculum
Select a minimum of 1 additional credit. 1
- General Education Requirements 17**

Total Program Credits 60

Program Start Dates

Fall, Spring, Summer

Transfer Opportunities

Saint Paul College has a transfer articulation agreement between the following program and post-secondary institutions for the baccalaureate degree programs listed below.

For more information please go to saintpaul.edu/Transfer.

Supply Chain Logistics AAS

- BA Individualized Studies
Metropolitan State University
- BA Marketing & Innovative Management
Concordia University, St. Paul
- BS Business Administration
Saint Mary's University,
Twin Cities Campus
- BS Global Supply Chain Management
Minnesota State University, Moorhead
- BS Marketing
Saint Mary's University,
Twin Cities Campus
- BS Supply Chain and
Operation Management
Metropolitan State University

Course Sequence

The course sequence listed on the back of this guide is recommended for a full-time student; however, this sequence is not required. Contact Program Faculty with questions.

See back of this guide for Course Sequence

Minimum Program Entry Requirements

Students entering this program must meet the following minimum program entry requirements:

Reading: Score of 78+ or grade of "C" or better in READ 0722

Writing: Score of 78+ or grade of "C" or better in ENGL 0922

Arithmetic: Score of 20+

Assessment Results and Prerequisites:

Students admitted into Saint Paul College programs may need to complete additional courses based on assessment results and course prerequisite requirements. Certain MATH, READ, and ENGL courses have additional prerequisites.

314A (7159)

Supply Chain Logistics AAS DEGREE *(continued)*

Course Sequence

The following sequence is recommended for a fulltime student; however, this sequence is not required. Contact Program Faculty with questions.

First Semester

ACCT 2410 Financial Accounting 1	4
BTEC 1421 Business Info Applications 1	3
BUSN 1410 Introduction to Business	3
BUSN 1449 Business Communications	3
Goal 1: ENGL 1711 Composition 1	4
Total Semester Credits	17

Second Semester

BSLM 2420 Supply Chain Management (spring only)	4
BSLM 2450 Procurement Principles and Applications (spring only)	3
BUSN 2472 Business Negotiation Skills	3
INTL 1512 Export Shipping and Compliance (spring only)	3
Goal 1: COMM 17XX	3
Total Semester Credits	16

Third Semester

BSLM 1410 Transportation Management (fall only)	3
BSLM 1510 Distribution Management (fall only)	3
BUSN 2110 Principles of Marketing	3
BUSN 2465 Business Ethics	3
Goal 5: ECON 1720 Macroeconomics OR ECON 1730 Microeconomics	3
Total Semester Credits	15

Fourth Semester

INTL 2420 U. S. Customs and Importing (spring only)	3
Business Elective	2
Goal 3 or 4: Natural Sciences OR Mathematical/Logical Reasoning	3
Goal 6: Humanities and Fine Arts	3
Mn Transfer Curriculum	1
Total Semester Credits	12

Total Program Credits60

Supply Chain Logistics CERTIFICATE

Program Overview

In order to be admitted to the Supply Chain Logistics certificate program, the student must have previous related work experience or a business degree (minimum – AAS). Program Faculty approval is required for admission. This certificate is not designed for entry level to the logistics field, but as an add-on certificate to enhance and build on prior knowledge.

Logistics management is concerned with the procurement, movement, storage and processing of materials and information across the whole of the supply chain, from acquisition of raw materials and components, through manufacturing, to delivery of finished products to end users.

This program provides students the opportunity of understanding modern supply chain management. Supply chain management demands a multidisciplinary and cross-functional approach to business which transcends the traditional functional boundaries and management disciplines that characterize many organizations.

This certificate program is transferable to the Supply Chain Logistics AAS Degree.

Career Opportunities

Supply Chain Logistics offers a wide variety of employment opportunities. Some of these are purchasing and supplier management, manufacturing logistics, inventory management, transport management, distribution, warehousing management, customer service management, information management and logistics and supply chain strategy. Because of the wide range of jobs open to graduates, prospective students are asked to consult with the program instructor for specific job forecasts.

Program Outcomes

1. Graduates will have knowledge and skills in distribution planning, transportation management, and logistics.
2. Graduates will have knowledge and skills in customer service.
3. Graduates will be prepared for positions in transportation, distribution, and supply chain management.
4. Graduates will have knowledge and skills to provide foresight of potential opportunities in the management of the supply chain.

Program Faculty

Jon Stambaugh jon.stambaugh@saintpaul.edu
651.846.1592

Part-time/Full-time Options

This program can be completed by using a combination of day, evening, Saturday and online courses. Part time and full-time options are available.

Program Faculty approval required for admission

This certificate is not designed for entry level to the logistics field, but as an add-on certificate to enhance and build on prior knowledge.

Program Requirements

Check off when completed

The student must have related work experience or a business degree (minimum – AAS) to be admitted to the Supply Chain Logistics Certificate.

Program Faculty approval required for admission.

Course	Cr
<input type="checkbox"/> BSLM 1410 Transportation Management	3
<input type="checkbox"/> BSLM 1510 Distribution Management	3
<input type="checkbox"/> BSLM 2420 Supply Chain Management	4
<input type="checkbox"/> BSLM 2450 Procurement Principles and Applications	3
<input type="checkbox"/> BUSN 2110 Principles of Marketing	3
<input type="checkbox"/> BUSN 2472 Business Negotiation Skills	3
Total Program Credits	19

Program Start Dates

Fall, Spring

Course Sequence

The following sequence is recommended; however, this sequence is not required. Contact Program Faculty with questions.

First Semester

BSLM 1410 Transportation Management (fall only)	3
BSLM 1510 Distribution Management (fall only)	3
BUSN 2472 Business Negotiation Skills	3
Total Semester Credits	9

Second Semester

BSLM 2420 Supply Chain Management (spring only)	4
BSLM 2450 Procurement Principles and Applications (spring only)	3
BUSN 2110 Principles of Marketing	3
Total Semester Credits	10

Total Program Credits 19

Minimum Program Entry Requirements

Students entering this program must meet the following minimum program entry requirements:

Reading: Score of 78+ or grade of "C" or better in READ 0722

Writing: Score of 78+ or grade of "C" or better in ENGL 0922

Arithmetic: Score of 20+

Requires additional education and/or experience in the field in addition to assessment requirements.

Assessment Results and Prerequisites:

Students admitted into Saint Paul College programs may need to complete additional courses based on assessment results and course prerequisite requirements. Certain MATH, READ, and ENGL courses have additional prerequisites.

In order to be admitted to the Supply Chain Logistics program, the student must have related work experience or a business degree (minimum – AAS Degree).

Faculty approval required for admission.

Degree option may have a greater requirement than this certificate.

315C (7186)

*Information is subject to change.
This Program Requirements Guide is not a contract.*

Career & Technical Education Programs

Automotive Service Technician

Automotive Service Technician AAS Degree (72 Credits)	64-65
Automotive Service Technician Diploma (56 Credits)	66-67

Truck Technician

Truck Technician Diploma (67 Credits)	68-69
---	-------

Cabinetmaking

Cabinetmaking Diploma (37 Credits)	70
--	----

Carpentry

Carpentry Diploma (42 Credits)	71
--	----

Electrical Technology

Electrical Technology Diploma (74 Credits)	72-73
--	-------

Electromechanical Systems

Electromechanical Systems Diploma (48 Credits)	74
Electromechanical Systems Certificate (32 Credits)	75

Pipefitting

Pipefitting Apprenticeship Building Trades (40 Credits)	76-77
Pipefitting Apprenticeship Service Diploma (40 credits)	78-79

Plumbing

Plumbing Diploma (44 Credits)	80
---	----

Sheet Metal

Sheet Metal/HVAC Ducts & Fittings AAS Degree (60 Credits)	81
Sheet Metal/HVAC Ducts & Fittings Diploma (40 Credits)	82

Welding

Welding Technology Certificate (16 Credits)	83
Welding Technology Diploma (48 Credits)	84
Robotic Welding Certificate (17 Credits)	85

CNC Toolmaking

CNC Toolmaking Diploma (63 Credits)	86
Machine Operator Certificate (Right Skills Now) (20 Credits)	87

Individualized Studies

Individualized Studies AAS (60 Credits)	88
---	----

360° eTECH Programs

Automation Technologies Certificate (30 Credits)	89
Machine Technologist Certificate (30 Credits)	90
Machining & Automation Diploma (52 Credits)	91-92
Production Technologies Certificate (16 Credits)	93
Welding Technology Certificate (30 Credits)	94

Automotive Service Technician AAS DEGREE

Program Overview

Automotive repair requires trained technicians skilled in the use of testing equipment, special tools, and the latest information and specifications to service the many types of automobiles. Technicians diagnose trouble in any one of thousands of automotive components. They work with many new systems each year that require new service techniques and training. Some of these include air conditioning units, emission control devices, alternators, electronic ignition, and electronic fuel injection.

Students are prepared to take the ASE certification tests when they have completed the program. ASE certifies technicians nationwide.

Students should have good mechanical aptitude, be in good physical condition and have the ability to get along with others. Students also need to be able to read and process technical information.

Career Opportunities

Opportunities are expected to be plentiful for automotive technicians with technical training according to the U.S. Department of Labor. The department also states that the growing complexity of automotive technology, such as the use of electronic and emissions control equipment increasingly necessitates that cars be serviced by professionals.

The auto technician may work in a dealership garage, an independent garage, or as a specialist. Opportunities exist for a technician to become a shop service sales person, new car dealership service manager, or shop owner.

Program Outcomes

1. Graduates will be prepared to pass all 8 ASE tests.
2. Graduates will have knowledge and skills in use of testing equipment, special tools, and specifications for servicing automobiles.
3. Graduates will have the knowledge and skills to diagnose problems in automotive systems.
4. Graduates will be prepared for employment as Automotive Service Technicians.
5. Graduates will have proficient communication skills for customer service.
6. Graduates will have business and management skills required of an automotive service technician.

*Information is subject to change.
This Program Requirements Guide is not a contract.*

Program Faculty

Llewellyn Olivier llewellyn.olivier@saintpaul.edu
 John Purcell john.purcell@saintpaul.edu
 David Vorderbruggen david.vorderbruggen@saintpaul.edu
 Jake Yernberg jake.yernberg@saintpaul.edu

Tool Costs

Students will need to supply their own basic tools and tool box. The estimated cost for professional quality tools and tool box is approximately \$2,000–\$3,000. Tool vendors will be on campus during the first week.

Program Requirements

Check off when completed

Successful completion of each semester in this program is a prerequisite for participation in the following semester.

Course	Cr
<input type="checkbox"/> AUTO 1415 Introduction to Automotive Technology	4
<input type="checkbox"/> AUTO 1430 Brakes	4
<input type="checkbox"/> AUTO 1441 Alignment & Suspension	4
<input type="checkbox"/> AUTO 1510 Clutch/Driveline Manual Transmission	3
<input type="checkbox"/> AUTO 1523 Four Wheel Drive Differential	3
<input type="checkbox"/> AUTO 1530 Basic Electrical & Battery	3
<input type="checkbox"/> AUTO 1540 Basic Engine Management	3
<input type="checkbox"/> AUTO 1550 Heating & Air Conditioning	4
<input type="checkbox"/> AUTO 2410 Starting & Charging Systems	3
<input type="checkbox"/> AUTO 2420 Electrical Accessories	3
<input type="checkbox"/> AUTO 2430 Engine Theory & Repair	4
<input type="checkbox"/> AUTO 2440 Engine Installation	2
<input type="checkbox"/> AUTO 2450 Introduction to Auto Computers	2
<input type="checkbox"/> AUTO 2513 Fuel Systems	3
<input type="checkbox"/> AUTO 2520 Engine Drivability	3
<input type="checkbox"/> AUTO 2530 Automatic Transmission Theory	2
<input type="checkbox"/> AUTO 2542 Automatic Transmission Diagnosis & Repair	4
<input type="checkbox"/> AUTO 2550 Specialized Lab 1	2
Subtotal	56
<hr/>	
General Education/MnTC Requirements	Cr
Refer to the Minnesota Transfer Curriculum Course List for each Goal Area	
<input type="checkbox"/> Goal 1: Communication	7
ENGL 1711 Composition 1 – 4 cr COMM 17XX – 3 cr	
<input type="checkbox"/> Goal 3 or Goal 4	3
Goal 3: Natural Sciences OR Goal 4: Mathematical/Logical Reasoning	
<input type="checkbox"/> Goal 5: History, Social Science, and Behavioral Sciences	3
<input type="checkbox"/> Goal 6: Humanities and Fine Arts	3
General Education Requirements	16
Total Program Credits	72

Program Start Dates

Fall, (Spring - if space available and with instructor permission)

Length of Program

This is a full-time, day and evening program. The program can be completed in four semesters. Students can enroll in the program only in the fall.

Admission Requirement

Admission requires completion of the Automotive Service Technician Diploma, or concurrent enrollment in the second year Auto Technician program.

Course Sequence

The course sequence listed on the back of this guide is recommended for a full-time student; however, this sequence is not required. Contact Program Faculty with questions.

See back of this guide for Course Sequence

Minimum Program Entry Requirements

Students entering this program must meet the following minimum program entry requirements:

Reading: Score of 60+ or grade of "C" or better in READ 0721

Writing: Score of 60+ or grade of "C" or better in ENGL 0921

Arithmetic: Score of 31+

Spatial assessment required: Score 10+

Shop/classroom visit recommended

Student must have a valid driver's license

Assessment Results and Prerequisites: Students admitted into Saint Paul College programs may need to complete additional courses based on assessment results and course prerequisite requirements. Certain MATH, READ, and ENGL courses have additional prerequisites.

278A (7164)

Automotive Service Technician AAS DEGREE *(continued)*

Course Sequence

The following sequence is recommended; however, this sequence is not required. Contact Program Faculty with questions.

First Semester

AUTO 1415 Introduction to Automotive Technology	4
AUTO 1430 Brakes	4
AUTO 1510 Clutch/Driveline Manual Transmission	3
AUTO 1530 Basic Electrical & Battery	3
ENGL 1711 Composition 1	4
Total Semester Credits	18

Second Semester

AUTO 1441 Alignment & Suspension	4
AUTO 1523 Four Wheel Drive Differential	3
AUTO 1540 Basic Engine Management	3
AUTO 1550 Heating & Air Conditioning	4
Goal 1: COMM 17XX	3
Total Semester Credits	17

Third Semester

AUTO 2410 Starting & Charging Systems	3
AUTO 2420 Electrical Accessories	3
AUTO 2430 Engine Theory & Repair	4
AUTO 2440 Engine Installation	2
AUTO 2450 Introduction to Auto Computers	2
Goal Area 5	3
Goal Area 3 or 4	3
Total Semester Credits	20

Fourth Semester

AUTO 2513 Fuel Systems	3
AUTO 2520 Engine Drivability	3
AUTO 2530 Auto Transmission Theory	2
AUTO 2542 Auto Tran Diagnosis & Repair	4
AUTO 2550 Specialized Lab 1	2
Goal Area 6	3
Total Semester Credits	17

Any Semester

General Education requirement courses may be taken before, after or concurrently with the Automotive Service Technician courses.

General Education Requirements	16
---	-----------

Total Program Credits	72
--	-----------

Transfer Opportunities

Saint Paul College has a transfer articulation agreement between the following program and post-secondary institutions for the baccalaureate degree programs listed below.

For more information please go to saintpaul.edu/Transfer.

Automotive Service Technician AAS

BS	Operations Management	Minnesota State University, Moorhead
BS	Automotive Engineering Technology	Minnesota State University, Mankato

Automotive Service Technician DIPLOMA

Program Overview

Automotive repair requires trained technicians skilled in the use of testing equipment, special tools, and the latest information and specifications to service the many types of automobiles. Technicians diagnose trouble in any one of thousands of automotive components. They work with many new systems each year that require new service techniques and training. Some of these include air conditioning units, emission control devices, alternators, electronic ignition, and electronic fuel injection. Students are prepared to take the ASE certification tests when they have completed the program. ASE certifies technicians nationwide.

Students should have good mechanical aptitude, be in good physical condition and have the ability to get along with others. Students also need to be able to read and process technical information.

Career Opportunities

Opportunities are expected to be plentiful for automotive technicians with technical training according to the U.S. Department of Labor.

The department also states that the growing complexity of automotive technology, such as the use of electronic and emissions control equipment increasingly necessitates that cars be serviced by professionals.

The auto technician may work in a dealership garage, an independent garage, or as a specialist. Opportunities exist for a technician to become shop service sales person, new car dealership service manager, or shop owner.

Program Outcomes

1. Graduates will be prepared to pass all 8 ASE tests.
2. Graduates will have knowledge and skills in use of testing equipment, special tools, and specifications for servicing automobiles.
3. Graduates will have the knowledge and skills to diagnose problems in automotive systems.
4. Graduates will be prepared for employment as Automotive Service Technicians.

Program Faculty

Llewellyn Olivier llewellyn.olivier@saintpaul.edu
 John Purcell john.purcell@saintpaul.edu
 David Vorderbruggen david.vorderbruggen@saintpaul.edu
 Jake Yernberg jake.yernberg@saintpaul.edu

Length of Program

This is a full-time, day and evening program. The program can be completed in four semesters. Students can enroll in the program only in the fall.

Tool costs

Students will need to supply their own basic tools and tool box. The estimated cost for professional quality tools and tool box is approximately \$2,000–\$3,000.

Tool vendors will be on campus during the first week.

Program Requirements

Check off when completed

Successful completion of each semester in this program is a prerequisite for participation in the following semester.

Course	Cr
<input type="checkbox"/> AUTO 1415 Introduction to Automotive Technology	4
<input type="checkbox"/> AUTO 1430 Brakes	4
<input type="checkbox"/> AUTO 1441 Alignment & Suspension	4
<input type="checkbox"/> AUTO 1510 Clutch/Driveline Manual Transmission	3
<input type="checkbox"/> AUTO 1523 Four Wheel Drive Differential	3
<input type="checkbox"/> AUTO 1530 Basic Electrical & Battery	3
<input type="checkbox"/> AUTO 1540 Basic Engine Management	3
<input type="checkbox"/> AUTO 1550 Heating & Air Conditioning	4
<input type="checkbox"/> AUTO 2410 Starting/Charging Systems	3
<input type="checkbox"/> AUTO 2420 Electrical Accessories	3
<input type="checkbox"/> AUTO 2430 Engine Theory & Repair	4
<input type="checkbox"/> AUTO 2440 Engine Installation	2
<input type="checkbox"/> AUTO 2450 Introduction to Auto Computers	2
<input type="checkbox"/> AUTO 2513 Fuel Systems	3
<input type="checkbox"/> AUTO 2520 Engine Drivability	3
<input type="checkbox"/> AUTO 2530 Automatic Transmission Theory	2
<input type="checkbox"/> AUTO 2542 Automatic Transmission Diagnosis & Repair	4
<input type="checkbox"/> AUTO 2550 Specialized Lab 1	2
Total Program Credits	56

*Information is subject to change.
 This Program Requirements Guide is not a contract.*

Program Start Dates

Fall

Transfer Opportunities

Saint Paul College has a transfer articulation agreement between the following program and post-secondary institution for the baccalaureate degree program listed below.

For more information please go to saintpaul.edu/Transfer.

Automotive Service Technician Diploma
 BS Operations Management
 Minnesota State University, Moorhead

Course Sequence

The course sequence listed on the back of this guide is recommended for a full-time student; however, this sequence is not required. Contact Program Faculty with questions.

See back of this guide for Course Sequence

Minimum Program Entry Requirements
 Students entering this program must meet the following minimum program entry requirements:

Reading: Score of 60+ or grade of "C" or better in READ 0721

Writing: Score of 38+

Arithmetic: Score of 31+

Spatial assessment required: Score 10+

Shop/classroom visit recommended

Student must have a valid driver's license

Assessment Results and Prerequisites:
 Students admitted into Saint Paul College programs may need to complete additional courses based on assessment results and course prerequisite requirements. Certain MATH, READ, and ENGL courses have additional prerequisites.

084D (7004)

Automotive Service Technician DIPLOMA *(continued)*

Course Sequence

The following full-time sequence is recommended.

First Semester

AUTO 1415 Introduction to Automotive Technology	4
AUTO 1430 Brakes	4
AUTO 1510 Clutch/Driveline Manual Transmission	3
AUTO 1530 Basic Electrical & Battery	3
Total Semester Credits.	14

Second Semester

AUTO 1441 Alignment & Suspension	4
AUTO 1523 Four Wheel Drive & Differential	3
AUTO 1540 Basic Engine Management	3
AUTO 1550 Heating & Air Conditioning	4
Total Semester Credits.	14

Third Semester

AUTO 2410 Starting & Charging Systems	3
AUTO 2420 Electrical Accessories	3
AUTO 2430 Engine Theory & Repair	4
AUTO 2440 Engine Installation	2
AUTO 2450 Introduction to Auto Computers	2
Total Semester Credits.	14

Fourth Semester

AUTO 2513 Fuel Systems	3
AUTO 2520 Engine Drivability	3
AUTO 2530 Auto Transmission Theory	2
AUTO 2542 Auto Tran Diagnosis & Repair	4
AUTO 2550 Specialized Lab 1	2
Total Semester Credits.	14

Total Program Credits 56

Truck Technician DIPLOMA

Program Overview

Truck Technicians diagnose trouble accurately with the use of modern testing equipment. They repair and service the entire truck and trailer including gas and diesel engines. They also work on air brakes, multi-speed transmissions, differentials, electrical systems, chassis and engine electronics, cooling systems, air conditioning and refrigeration, and many more components of today's modern truck.

Career Opportunities

Maintenance departments, which have the responsibility for the repair and the maintenance of the entire truck, need skilled graduates to fill truck technician positions. Many technicians find employment with companies that own a fleet of vehicles such as truck lines, bus lines, and construction companies. Other technicians work for small repair shops, truck dealerships, heavy equipment dealers and the government. Employment of truck technicians is expected to increase faster than average according to the U.S. Department of Labor.

Program Outcomes

1. Graduates will have the knowledge and skills to service and repair medium and heavy duty trucks and trailers.
2. Graduates will have acquired supervised work experience servicing and repairing medium and heavy duty trucks and trailers.
3. Graduates will be prepared for employment as entry level truck technicians and truck preventative maintenance technicians.
4. Graduates will have mastered the general education program requirements for work and life roles.

Additional Requirements/Recommendations

The student should be capable of passing a rigorous physical examination with emphasis on eyesight, color vision, hearing, back condition and motor coordination.

Applicants should be high school graduates or equivalent with good reading ability and an understanding of basic mathematics in order to understand and apply technical information.

Drug test, background check, driving record, and a commercial drivers license may also be required by many employers.

Program Faculty

Joel Pearson joel.pearson@saintpaul.edu
651.846-1795

Patrick Rafferty patrick.rafferty@saintpaul.edu
651.846.1414

Textbook and supply costs

The following are estimated costs:

- Textbooks: \$450
- Tools: \$1,000–\$2,000 depending on brand of tools purchased.

Program Requirements

Check off when completed

Course	Cr
<input type="checkbox"/> TRKM 1400 Introduction and Safety	1
<input type="checkbox"/> TRKM 1445 Truck Welding 1	2
<input type="checkbox"/> TRKM 1455 Truck Welding 2	2
<input type="checkbox"/> TRKM 1521 Electrical 1	5
<input type="checkbox"/> TRKM 1522 Electrical 2	5
<input type="checkbox"/> TRKM 1551 Clutch and Transmission	5
<input type="checkbox"/> TRKM 1552 Driveshafts and Differentials	4
<input type="checkbox"/> TRKM 1553 Automatic and Automated Transmissions	4
<input type="checkbox"/> TRKM 1560 Truck Brake Systems	6
<input type="checkbox"/> TRKM 2401 Steering and Suspension Systems	6
<input type="checkbox"/> TRKM 2425 Truck Cab Climate Control Systems	3
<input type="checkbox"/> TRKM 2440 Gasoline Engines	6
<input type="checkbox"/> TRKM 2511 Diesel Engines 1	6
<input type="checkbox"/> TRKM 2512 Diesel Engines 2	6
<input type="checkbox"/> TRKM 2540 Preventive Maintenance	3
Subtotal	64

General Education/MnTC Requirements Cr

Refer to the Minnesota Transfer Curriculum Course List for each Goal Area

- Any college level general education course 3
- General Education Requirements 3**

Total Program Credits 67

Program Start Dates

Fall

Full-time enrollment is required

This is a two-year, full-time day program.

- Introduction and Safety must be taken concurrently with the other truck technician classes at the start of the program.
- It is recommended that the general education requirements be taken in the summer term before the first year or between the first and second years.

Transfer Opportunities

Saint Paul College has a transfer articulation agreement between the following program and post-secondary institution for the baccalaureate degree program listed below.

For more information please go to saintpaul.edu/Transfer.

Truck Technician Diploma

BS Operations Management
Minnesota State University, Moorhead

Course Sequence

The course sequence listed on the back of this guide is recommended for a full-time student; however, this sequence is not required. Contact Program Faculty with questions.

See back of this guide for Course Sequence

Minimum Program Entry Requirements

Students entering this program must meet the following minimum program entry requirements:

Reading: Score of 60+ or grade of "C" or better in READ 0721

Writing: Score of 38+

Arithmetic: Score of 31+

Spatial assessment required: Score 10+

Assessment Results and Prerequisites:

Students admitted into Saint Paul College programs may need to complete additional courses based on assessment results and course prerequisite requirements. Certain MATH, READ, and ENGL courses have additional prerequisites.

100D (7066)

*Information is subject to change.
This Program Requirements Guide is not a contract.*

Truck Technician DIPLOMA *(continued)*

Course Sequence

This diploma program generally includes four semesters of full-time study. The course sequence will depend upon when a student starts the Truck Technician program. Each of the four required semester blocks is offered once every other year. Students beginning Fall Semester will follow the following sequence outlined.

First Semester

TRKM 1400 Introduction and Safety	1
TRKM 1445 Truck Welding 1	2
TRKM 1521 Electrical 1	5
TRKM 1522 Electrical 2	5
TRKM 1552 Driveshafts and Differentials	4
Total Semester Credits	17

Second Semester

TRKM 1455 Truck Welding 2	2
TRKM 1551 Clutch and Transmission	5
TRKM 1553 Automatic and Automated Transmissions	4
TRKM 1560 Truck Brake Systems	6
Total Semester Credits	17

Third Semester

TRKM 2401 Steering and Suspension Systems	6
TRKM 2425 Truck Cab Climate Control Systems	3
TRKM 2440 Gasoline Engines	6
Total Semester Credits	15

Fourth Semester

TRKM 2511 Diesel Engines 1	6
TRKM 2512 Diesel Engines 2	6
TRKM 2540 Preventive Maintenance	3
Total Semester Credits	15

General Education Requirement (any)3
 May be taken any semester, but Summer Term is recommended.

Total Program Credits67

Cabinetmaking DIPLOMA

Program Overview

Cabinetmakers are skilled in the phases of cabinet construction from the initial drafting and layout, to material cutting, assembly, finishing and installation. The principles used in building kitchen cabinets are also used in building store fixtures, furniture and all other types of woodworking. The program prepares students to work for cabinet manufacturers and custom cabinet shops.

Career Opportunities

New construction in housing and industry, and the renovation and modernization of existing structures are expected to increase the demand for cabinetmakers.

Cabinetmaking graduates find positions in kitchen cabinet shops, lumber companies, sash and door factories, store fixture manufacturers, display shops, wood specialty shops, and furniture repair shops. Some graduates operate their own business.

Program Outcomes

1. Graduates will have acquired supervised hands-on experience building framed and frameless cabinetry.
2. Graduates will have knowledge, skill, and hands-on experience in the use of CAD/CAM software and CNC equipment.
3. Graduates will have knowledge, skill, and hands-on experience with wood stains, finishes and finishing equipment.
4. Graduates will have knowledge, skill, and hands-on experience in plastic laminate technology and fabrication.
5. Graduates will have acquired supervised hands-on experience in raised panel door layout, machinery set up, and production.
6. Graduates will have the knowledge, skills, and hands-on experience on the safe operation of woodworking equipment.

Transfer Opportunities

Saint Paul College has a transfer articulation agreement between the following program and post-secondary institution for the baccalaureate degree program listed below.

For more information please go to saintpaul.edu/Transfer.

Cabinetmaking Diploma

BS Operations Management
Minnesota State University, Moorhead

Program Faculty

Thomas Hillstead
thomas.hillstead@saintpaul.edu

Part-time/Full-time options

Part-time and full-time options available. Technical courses are offered during days.

Textbook, tool, and supply costs

Additional program costs total approximately \$1,250 for the following:

- Tools: \$500.00
- Books & Supplies: \$350.00
- Projects (costs vary) about: \$400.00

Program Requirements

Check off when completed

MATH 1411 – Applied Math is required for program graduation. It should be taken by the end of the first semester.

Course	Cr
<input type="checkbox"/> CABT 1450 Print Reading	2
<input type="checkbox"/> CABT 1455 Traditional Machining Methods	5
<input type="checkbox"/> CABT 1460 Wood Technology	2
<input type="checkbox"/> CABT 1465 Furniture & Residential Cabinetry	5
<input type="checkbox"/> CABT 1470 CAD/CNC	2
<input type="checkbox"/> CABT 1475 Industrial Machining Methods	4
<input type="checkbox"/> CABT 2450 Surface Applications	4
<input type="checkbox"/> CABT 2455 Casework & Millwork	5
<input type="checkbox"/> CABT 2515 CNC Cabinet Design	3
<input type="checkbox"/> Choose one of the following	2
CABT 2690 Capstone Project/Open Lab	
CABT 2695 Internship	
<input type="checkbox"/> MATH 1411 Applied Math	3
Total Program Credits	37

Program Start Dates

Fall, Spring

Additional Requirements/Recommendations

Mathematics and drawing skills are helpful.

Students need to be alert, physically fit and have good vision.

Students are expected to attend all classes and be prompt.

It is necessary to have good hand and eye coordination. Safety will be a major factor in operating all equipment. Safety is taught and students must pass all safety tests before operating equipment.

Course Sequence

The following sequence is recommended for a full-time student; however, this sequence is not required. Not all courses are offered each semester.

Fall Semester

CABT 1450 Print Reading	2
CABT 1455 Traditional Machining Methods	5
CABT 1460 Wood Technology	2
CABT 1465 Furniture & Residential Cabinetry	5
CABT 1470 CAD/CNC	2
MATH 1411 Applied Math	3
Total Semester Credits	19

Spring Semester

CABT 1475 Industrial Machining Methods	4
CABT 2450 Surface Applications	4
CABT 2455 Casework & Millwork	5
CABT 2515 CNC Cabinet Design	3
Choose one of the following	2
CABT 2690 Capstone Project/Open Lab	
CABT 2695 Internship	
Total Semester Credits	18

Total Program Credits 37

Minimum Program Entry Requirements

Students entering this program must meet the following minimum program entry requirements:

Reading: Score of 60+ or grade of "C" or better in READ 0721

Writing: Score of 38+

Arithmetic: Score of 31+

Assessment Results and Prerequisites:

Students admitted into Saint Paul College programs may need to complete additional courses based on assessment results and course prerequisite requirements. Certain MATH, READ, and ENGL courses have additional prerequisites.

085D (7040)

*Information is subject to change.
This Program Requirements Guide is not a contract.*

Carpentry DIPLOMA

Program Overview

Construction is the largest industry in terms of investment and manpower expended. Carpenters make up the largest trade group in the construction industry. They erect the wood framework in buildings; they install wood paneling, cabinets, door and window frames, and hardware; and they build stairs and frame roofs. Carpenters work under a wide variety of conditions, indoors and out, in all types of weather. They use many different hand and power tools working with wood, concrete, metals, plastics, and other construction materials.

Good work habits, mechanical aptitude, and strong communication and math skills are necessary to become a successful carpenter. Carpenters must be able to climb, lift, carry, measure, calculate, and plan their work. They often work at considerable heights.

Career Opportunities

Construction activity continues to be strong. Demand for quality carpenters exists in residential, commercial, and heavy construction. Increased activity in infrastructure and building renovation has provided additional opportunities for carpenters.

Carpenters can be involved in the many different phases of a building project or choose to specialize in areas such as framing, drywall, acoustic ceilings, concrete form building, hardware, and millwork. Many graduates continue their training by entering a formal apprentice program. Carpenter apprentices advance to journey person by working on the job and attending classes related to their work. Advancement can continue to lead carpenter, carpenter foreman, and job superintendent. Carpenters are employed by a wide variety of construction contractors, or they may choose to become self-employed in their own business.

Transfer Opportunities

Saint Paul College has a transfer articulation agreement between the following program and post-secondary institution for the baccalaureate degree program listed below.

For more information please go to saintpaul.edu/Transfer.

Carpentry Diploma

BS Operations Management
Minnesota State University, Moorhead

*Information is subject to change.
This Program Requirements Guide is not a contract.*

Program Outcomes

1. Graduates will have the knowledge and skills to safely use hand and portable power tools used by carpenters in the construction industry.
2. Graduates will be able to work with wood, plastics, concrete, metals, gypsum, and various fiber composite products used by carpenters in the construction industry.
3. Graduates will have practiced procedures used by carpenters in framing layout, stair construction, wood and steel framing, and installation of doors, windows, and cabinets.
4. Graduates will be familiar with forming systems and types of scaffold used in concrete construction.
5. Graduates will be familiar with and have practiced job site safety requirements.
6. Graduates will be able to operate instruments and demonstrate procedures used in building layout.
7. Graduates will display effective work habits deemed necessary by employers.
8. Graduates will be prepared for entry level employment as carpenters and admission to the Carpenters Apprentice Training Program.

Program Faculty

Perry Franzen perry.franzen@saintpaul.edu
651.846.1391

Full-time enrollment is required

This is a full-time day program. Students should plan for a full day of classes.

Special supplies and tool costs

Students should expect to spend approximately \$1,100, beyond the cost of tuition, fees, and books, for special supplies and tools. A list is available from the advisor.

Program Requirements

Check off when completed

Course	Cr
<input type="checkbox"/> CARP 1410 Project Estimating	3
<input type="checkbox"/> CARP 1420 Construction Blueprint Reading	2
<input type="checkbox"/> CARP 1430 Intro to Carpentry & Hand Tools	3
<input type="checkbox"/> CARP 1510 Intermediate Carpentry	5
<input type="checkbox"/> CARP 1521 Building Technology	5
<input type="checkbox"/> CARP 1522 Power Tool and Shop Procedures	5
<input type="checkbox"/> CARP 2410 Advanced Carpentry	6
<input type="checkbox"/> CARP 2421 Fieldwork and Carpentry Procedures	5
<input type="checkbox"/> CARP 2422 Carpentry Concrete Technology and Installation	5
<input type="checkbox"/> MATH 1411 Applied Mathematics	3

Total Program Credits 42

Program Start Dates

Summer

Course Sequence

The following sequence is required.

First Term

CARP 1410 Project Estimating	3
CARP 1420 Construction Blueprint Reading	2
CARP 1430 Intro to Carpentry & Hand Tools	3
Total Semester Credits	8

Second Semester

CARP 1510 Intermediate Carpentry	5
CARP 1521 Building Technology	5
CARP 1522 Power Tool and Shop Procedures	5
MATH 1411 Applied Mathematics	3
Total Semester Credits	18

Third Semester

CARP 2410 Advanced Carpentry	6
CARP 2421 Fieldwork and Carpentry Procedures	5
CARP 2422 Carpentry Concrete Technology and Installation	5
Total Semester Credits	16

Total Program Credits 42

Minimum Program Entry Requirements

Students entering this program must meet the following minimum program entry requirements:

Reading: Score of 60+ or grade of "C" or better in READ 0721

Writing: Score of 38+

Arithmetic: Score of 31+

Assessment Results and Prerequisites: Students admitted into Saint Paul College programs may need to complete additional courses based on assessment results and course prerequisite requirements. Certain MATH, READ, and ENGL courses have additional prerequisites.

086D (7039)

Electrical Technology DIPLOMA

Program Overview

An electrician is employed to install electrical wiring and equipment for lighting, heating, cooling and other power requirements in residential, commercial and industrial buildings. Using blueprints, diagrams and specifications, students perform installations in accordance with national, state and local safety codes. Considerable physical exertion is often required and the work may be performed outdoors or under such hazardous conditions as heights, unfinished construction or high voltages.

Students should have an interest and aptitude in applied algebra, trigonometry, drawing and science. Good eyesight and color vision are important.

Career Opportunities

According to the U.S. Department of Labor, "As the population and the economy grow... more electricians will be needed to maintain the electrical systems used by industry and to install electrical devices and wiring in new homes, factories, offices and other structures."

Graduates are employed as apprentices by electrical construction firms. Upon completion of apprenticeship and the obtaining of a journey person's license, students are open to opportunities as master electricians, inspectors, contractors, estimators and repair persons.

Program Outcomes

1. Graduates will have the ability to communicate and conduct themselves in a professional manner with the customers and co-workers.
2. Graduates will have the skills for performing entry level tasks required of an apprentice electrician in residential, commercial and industrial construction.
3. Graduates will have knowledge of the National Electric Code, enabling them to legally and safely install electrical services with supervision.
4. Graduates will have the ability to apply electrical theory to practical applications.
5. Graduates will meet the MN Department of Labor and Industry's electrical program requirement of specific curriculum and 95% course attendance policy.

Apprenticeship opportunity

Completion of the Electrical Technology Diploma program meets the Minnesota Department of Labor and Industry requirements. 95% attendance in each course and completion of the diploma may qualify for one year of apprenticeship credit.

Program Faculty

George Schaus	george.schaus@saintpaul.edu 651.846.1631
Julie Selton	julie.selton@saintpaul.edu 651.846.1770
Keith Setley	keith.setley@saintpaul.edu 651.846.1539
Dean Weikle	dean.weikle@saintpaul.edu 651.846.1790

Textbook, tool, and supply costs

- Textbooks are required the first day of class. Go to www.saintpaulcollegebookstore.com for textbook information.
- Multimeter and hand tools, approximately \$500 new.

Program Requirements

Check off when completed

Certain classes must be taken concurrently and certain classes are prerequisites to other classes.

Course	Cr
<input type="checkbox"/> ELTN 1410 National Electrical Code 1 and Trade Calculations	4
<input type="checkbox"/> ELTN 1422 Direct Current Circuit Analysis	5
<input type="checkbox"/> ELTN 1432 Alternating Current Circuit Analysis	5
<input type="checkbox"/> ELTN 1442 Single-Phase Motors and Generators	5
<input type="checkbox"/> ELTN 1512 Three-Phase Systems Motors and Generators	5
<input type="checkbox"/> ELTN 1522 Introduction to Electronics and Test Equipment	5
<input type="checkbox"/> ELTN 1532 Intermediate Electronics and PLC's	5
<input type="checkbox"/> ELTN 1540 Low Voltage Systems and Job Site Safety	4
<input type="checkbox"/> ELTN 2410 Distribution Power and Specialty Transformers	4
<input type="checkbox"/> ELTN 2420 Motor Controls	4
<input type="checkbox"/> ELTN 2430 Residential Wiring and Blueprint Reading	4
<input type="checkbox"/> ELTN 2440 Heating and Cooling System Controls	4
<input type="checkbox"/> ELTN 2510 Wiring Methods and Systems	4
<input type="checkbox"/> ELTN 2522 Commercial Wiring Methods	5
<input type="checkbox"/> ELTN 2532 Industrial Wiring Methods and Service Entrance	5
<input type="checkbox"/> ELTN 2540 National Electrical Code 2	4
<input type="checkbox"/> ELTN 2550 Renewable Energy	2

Total Program Credits 74

*Information is subject to change.
This Program Requirements Guide is not a contract.*

Program Start Dates

Fall, Spring

Students must attend orientation.

Transfer Opportunities

Saint Paul College has a transfer articulation agreement between the following program and post-secondary institution for the baccalaureate degree program listed below.

For more information please go to saintpaul.edu/Transfer.

Electrical Technology Diploma

BS Operations Management
Minnesota State University, Moorhead

Course Sequence

The course sequence listed on the back of this guide is recommended for a full-time student; however, this sequence is not required. Contact Program Faculty with questions.

See back of this guide for Course Sequence

Minimum Program Entry Requirements

Students entering this program must meet the following minimum program entry requirements:

Reading: Score of 60+ or a grade of "C" or better in READ 0721

Writing: Score of 60+ or a grade of "C" or better in ENGL 0921

Arithmetic: Score of 31+

Assessment Results and Prerequisites: Students admitted into Saint Paul College programs may need to complete additional courses based on assessment results and course prerequisite requirements. Certain MATH, READ, and ENGL courses have additional prerequisites.

309D (7158)

Electrical Technology DIPLOMA *(continued)*

Course Sequence

The following full-time sequence is recommended.

First Semester

ELTN 1410 National Electrical Code 1 and Trade Calculations	4
ELTN 1422 Direct Current Circuit Analysis	5
ELTN 1432 Alternating Current Circuit Analysis	5
ELTN 1442 Single-Phase Motors and Generators.	5
Total Semester Credits.	19

Second Semester

ELTN 1512 Three-Phase Systems Motors and Generators	5
ELTN 1522 Introduction to Electronics and Test Equipment.	5
ELTN 1532 Intermediate Electronics and PLC's	5
ELTN 1540 Low Voltage Systems and Job Site Safety	4
Total Semester Credits.	19

Third Semester

ELTN 2410 Distribution Power and Specialty Transformers	4
ELTN 2420 Motor Controls	4
ELTN 2430 Residential Wiring and Blueprint Reading.	4
ELTN 2440 Heating and Cooling System Controls	4
Total Semester Credits.	16

Fourth Semester

ELTN 2510 Wiring Methods and Systems.	4
ELTN 2522 Commercial Wiring Methods	5
ELTN 2532 Industrial Wiring Methods and Service Entrance	5
ELTN 2540 National Electrical Code 2	4
ELTN 2550 Renewable Energy	2
Total Semester Credits.	20

Total Program Credits	74
--	-----------

Electromechanical Systems DIPLOMA

Program Overview

Electromechanical systems, also referred to as mechatronics, is a new and rapidly growing field that integrates electronics, mechanics, pneumatics, hydraulics, and computer control systems to create new and improved automated manufacturing production systems. This program is designed for people who are interested in plant maintenance (troubleshooting & repair), process set up, installation, and commissioning.

Electromechanical Systems move beyond simply cross-training employees, as the discipline recognizes that individuals need to be trained in five areas: mechanical, electrical, fluid power, process control, and industrial programming.

Students/electricians that previously acquired a diploma/AAS degree in the study of electricity may transfer in credits toward the Electromechanical Systems diploma. Students should have an interest and aptitude in applied algebra, trigonometry, drawing and science. Good eyesight and color vision are important.

Career Opportunities

The Electromechanical Systems program prepares students for careers requiring specialized skills in electricity, electronics, instrumentation, programmable logic controllers, microprocessors, automation and robotics. Students will become multi-skilled technicians capable of solving the many complex problems of manufacturing automation. Students will be prepared for a wide variety of careers including: Instrument Technician, Electrical Technician, Electromechanical Technician, Robotics Technician, Electronics Mechanic, Machine Repair & Maintenance, Motor Installer, Instrumentation Calibration Technician, Industrial Programmer, PLC Programmer, and Field Service.

These jobs are found in a wide range of fields including: oil refineries, water treatment, wastewater treatment, manufacturing plants, chemical, medical, electronics, agriculture, biotechnology and automotive industries.

Program Outcomes

1. Graduates will have the ability to communicate and conduct themselves in a professional manner with the customers and co-workers.
2. Graduates will be able to work on various styles of drives and pumps.
3. Graduates will be able to program using specialized industrial languages.
4. Graduates will have an understanding of machine logic and how electric, pneumatic, and hydraulic circuits interact with it.
5. Graduates will be able to work with various process controls systems.

Program Faculty

Travis Schachtner

travis.schachtner@saintpaul.edu

651.403.4163

Program Delivery

Class work for this program consists of online course delivery with hands-on labs to reinforce that lessons learned as well as one-on-one with instructors.

Additional Program Requirements/Costs

Students must attend orientation.

- Textbooks are required the first day of class. Go to saintpaulcollegebookstore.com for textbook information.
- Students are responsible for having their own Personal Protective Equipment (PPE) to participate in the labs.

Program Requirements

Check off when completed

Certain classes must be taken concurrently and certain classes are prerequisites to other classes.

Course	Cr
<input type="checkbox"/> EMEC 1511 AC/DC Fundamentals	4
<input type="checkbox"/> EMEC 1521 Electrical Motors	4
<input type="checkbox"/> EMEC 1530 Motor Controls	4
<input type="checkbox"/> EMEC 1540 Motor Drives	4
<input type="checkbox"/> EMEC 2400 Industrial Basics	4
<input type="checkbox"/> EMEC 2500 Fluid System Fundamentals	4
<input type="checkbox"/> EMEC 2620 Mechanical Fundamentals I	4
<input type="checkbox"/> EMEC 2625 Mechanical Fundamentals 2	4
<input type="checkbox"/> EMEC 2741 Electromechanical Troubleshooting & Maintenance	4
<input type="checkbox"/> EMEC 2751 Automated Process Control	4
<input type="checkbox"/> EMEC 2760 Programming for Robotic Manufacturing	4
<input type="checkbox"/> EMEC 2770 Advanced PLC Programming	4

Total Program Credits 48

Program Start Dates

Fall, Spring

Course Sequence

This course sequence is recommended for a full-time student; however, this sequence is not required. Students should consult with the Program Advisor each semester.

Not all courses are offered each semester.

First Semester

EMEC 1511 AC/DC Fundamentals	4
EMEC 1521 Electrical Motors	4
EMEC 1530 Motor Controls	4
EMEC 1540 Motor Drives	4
Total Semester Credits	16

Second Semester

EMEC 2400 Industrial Basics	4
EMEC 2500 Fluid System Fundamentals	4
EMEC 2620 Mechanical Fundamentals I	4
EMEC 2625 Mechanical Fundamentals 2	4
Total Semester Credits	16

Third Semester

EMEC 2741 Electromechanical Troubleshooting & Maintenance	4
EMEC 2751 Automated Process Controls	4
EMEC 2760 Programming for Robotic Manufacturing	4
EMEC 2770 Advanced PLC Programming	4
Total Semester Credits	16

Total Program Credits 48

Minimum Program Entry Requirements

Students entering this program must meet the following minimum program entry requirements:

Reading: Score of 60+ or grade of "C" or better in READ 0721

Writing: Score of 60+ or grade of "C" or better in ENGL 0921

Arithmetic: Score of 52+

Assessment Results and Prerequisites:

Students admitted to Saint Paul College programs may need to complete additional courses based on assessment results and course prerequisite requirements. Certain MATH, READ, and ENGL courses have additional prerequisites.

349D (7224)

*Information is subject to change.
This Program Requirements Guide is not a contract.*

Electromechanical Systems CERTIFICATE

Program Overview

Note: Students must be a journeyman electrician, have a Construction Electricity (CNEL) or Electrical Technology (ELTN) Diploma/AAS, or have Instructor approval.

Electromechanical systems, also referred to as mechatronics, is a new and rapidly growing field that integrates electronics, mechanics, pneumatics, hydraulics, and computer control systems to create new and improved automated manufacturing production systems. This program is designed for people who are interested in plant maintenance (troubleshooting & repair), process set up, installation, and commissioning.

Electromechanical Systems move beyond simply cross-training employees, as the discipline recognizes that individuals need to be trained in five areas: mechanical, electrical, fluid power, process control, and industrial programming.

The Electromechanical Systems Certificate program requires high school graduation or equivalent. Students/electricians that previously acquired a diploma/AAS degree in the study of electricity may transfer in credits toward the Electromechanical certificate. Students should have an interest and aptitude in applied algebra, trigonometry, drawing and science. Good eyesight and color vision are important.

Career Opportunities

The Electromechanical Systems program prepares students for careers requiring specialized skills in electricity, electronics, instrumentation, programmable logic controllers, microprocessors, automation and robotics. Students will become multi-skilled technicians capable of solving the many complex problems of manufacturing automation. Students will be prepared for a wide variety of careers including: Instrument Technician, Electrical Technician, Electromechanical Technician, Robotics Technician, Electronics Mechanic, Machine Repair & Maintenance, Motor Installer, Instrumentation Calibration Technician, Industrial Programmer, PLC Programmer, and Field Service.

These jobs are found in a wide range of fields including: electrical utilities, oil refineries, water treatment, wastewater treatment, manufacturing plants, chemical, medical, electronics, agriculture, biotechnology and automotive industries.

Program Outcomes

1. Graduates will have the ability to communicate and conduct themselves in a professional manner with the customers and co-workers.
2. Graduates will be able to work on various styles of drives and pumps.
3. Graduates will be able to program using specialized industrial languages.
4. Graduates will have an understanding of machine logic and how electric, pneumatic, and hydraulic circuits interact with it.
5. Graduates will be able to work with various process controls systems.

Program Faculty

Travis Schachtner
travis.schachtner@saintpaul.edu
651.403.4163

Program Requirements

Check off when completed

Certain classes must be taken concurrently and certain classes are prerequisites to other classes.

Course	Cr
<input type="checkbox"/> EMEC 2400 Industrial Basics	4
<input type="checkbox"/> EMEC 2500 Fluid System Fundamentals	4
<input type="checkbox"/> EMEC 2620 Mechanical Fundamentals I	4
<input type="checkbox"/> EMEC 2625 Mechanical Fundamentals 2	4
<input type="checkbox"/> EMEC 2741 Electromechanical Troubleshooting & Maintenance	4
<input type="checkbox"/> EMEC 2751 Automated Process Control	4
<input type="checkbox"/> EMEC 2760 Programming for Robotic Manufacturing	4
<input type="checkbox"/> EMEC 2770 Advanced PLC Programming	4
Total Program Credits	32

Additional Program Materials Costs

- Students must attend orientation.
- Textbooks are required the first day of class. Go to www.saintpaulcollegebookstore.com for textbook information.
- Students are responsible for having their own Personal Protective Equipment (PPE) to participate in the labs.

*Information is subject to change.
This Program Requirements Guide is not a contract.*

Program Start Dates

Fall, Spring

Class work for this program consist of online course delivery with hands-on labs to reinforce that lessons learned as well as one-on-one with instructors.

Course Sequence

This course sequence is recommended for a full-time student; however, this sequence is not required.

Students should consult with a Program Advisor each semester.

Not all courses are offered each semester.

First Semester

EMEC 2400 Industrial Basics	4
EMEC 2500 Fluid System Fundamentals	4
EMEC 2620 Mechanical Fundamentals 1	4
EMEC 2625 Mechanical Fundamentals 2	4
Total Semester Credits	16

Second Semester

EMEC 2741 Electromechanical Troubleshooting & Maintenance	4
EMEC 2751 Automated Process Control	4
EMEC 2760 Programming for Robotic Manufacturing	4
EMEC 2770 Advanced PLC Programming	4
Total Semester Credits	16

Total Program Credits 32

Minimum Program Entry Requirements

Students entering this program must meet the following minimum program entry requirements:

Reading: Score of 60+ or grade of "C" or better in READ 0721

Writing: Score of 60+ or grade of "C" or better in ENGL 0921

Arithmetic: Score of 52+

Assessment Results and Prerequisites:

Students admitted to Saint Paul College programs may need to complete additional courses based on assessment results and course prerequisite requirements. Certain MATH, READ, and ENGL courses have additional prerequisites.

349C

Pipefitting Apprenticeship Building Trades DIPLOMA

Program Overview

Pipefitters install, maintain, and repair high and low pressure steam systems, high and low pressure hot water systems, snow melting systems, refrigeration systems, heating, gas and oil piping, pneumatic, electronic controls, air conditioning and also provide instrumentation and valve repair. These skills are used working in residential, commercial, and industrial installations. These systems are installed in all types of weather conditions. Applicants must be high school graduates or the equivalent and should enjoy working in a demanding trade that requires both mental alertness and physical stamina. Pipefitters do heavy lifting and are required to work both indoors and outside, often times in confined spaces.

Career Opportunities

Pipefitters, Steamfitters, and HVACR Technicians work in all aspects of the heating, air conditioning, refrigeration, and temperature control fields. They are also employed at oil refineries, chemical plants, food processing facilities, manufacturing plants, retail and wholesale food stores, and ice rinks.

We also have maintenance pipefitters working at the University of Minnesota, Saint Paul School District, Metropolitan Council, Saint Paul Government Center, and Energy Park. We have pipefitters installing and maintaining refrigeration trucks, trailers, and buses at Thermo King Sales and Service.

Program Outcomes

1. Graduates will have the science and math skills needed in the piping systems.
2. Graduates will have the basic knowledge and skills necessary to install piping systems in commercial and industrial buildings.
3. Graduates will have basic knowledge to properly install and operate low- and high-pressure steam systems.

Transfer Opportunities

Saint Paul College has a transfer articulation agreement between the following program and post-secondary institution for the baccalaureate degree program listed below.

For more information please go to saintpaul.edu/Transfer.

Pipefitting Apprenticeship Building Trades Diploma

BS Operations Management
Minnesota State University, Moorhead

Program Faculty

Bill Lombard Training Coordinator
bill.lombard@local455jatc.com

Program Requirements

Check off when completed

Course	Cr
<input type="checkbox"/> PIPE 2606 Pipefitting 2	2
<input type="checkbox"/> PIPE 2615 Pipe Layout & Installation 1.	2
<input type="checkbox"/> PIPE 2616 Pipe Layout & Installation 2.	2
<input type="checkbox"/> PIPE 2625 Steam, Hot Water & Gas Controls	2
<input type="checkbox"/> PIPE 2631 Industrial Pneumatics	2
<input type="checkbox"/> PIPE 2641 Foreman Leadership	1
<input type="checkbox"/> PIPE 2642 Piping Design	1
<input type="checkbox"/> PIPE 2651 Refrigeration Code	1
<input type="checkbox"/> PIPE 2652 Oil Code	1
<input type="checkbox"/> PIPE 2653 Gas Code	2
<input type="checkbox"/> PIPE 2654 Hot Water Code	2
<input type="checkbox"/> PIPE 2655 Ammonia Code	2
<input type="checkbox"/> PIPE 2656 High Pressure Steam Code	2
<input type="checkbox"/> PIPE 2658 OSHA30/Pro10/UA Heritage	2
<input type="checkbox"/> PIPE 2660 Industrial Rigging	2
<input type="checkbox"/> RWLD 2621 Apprentice Pipe Weld 1.	2
<input type="checkbox"/> RWLD 2622 Apprentice Pipe Weld 2.	2
<input type="checkbox"/> RWLD 2623 Apprentice Pipe Weld 3.	2
<input type="checkbox"/> RWLD 2624 Apprentice Pipe Weld 4.	2
<input type="checkbox"/> RWLD 2660 Apprentice Pipe Weld 1 Advanced	2
<input type="checkbox"/> RWLD 2661 Apprentice Pipe Weld 2 Advanced	2
<input type="checkbox"/> RWLD 2662 Apprentice Pipe Weld 3 Advanced	2
<input type="checkbox"/> RWLD 2663 Apprentice Pipe Weld 4 Advanced	2

Total Program Credits 40

Special Features

Students are employed by contractors who are signatory with UA Local Union 455 St. Paul Pipefitters.

Restricted Enrollment

The Pipefitting Apprenticeship Building Trades Diploma is a restricted enrollment joint program offered through the St. Paul Pipefitters Local 455 and Saint Paul College. Admission to the Pipefitters Apprenticeship program is required for enrollment in this program. Courses are offered only as part-time evening and cannot be combined with any other apprenticeship program. Call 651.455.5282 for application information.

Course Sequence

The following sequence is subject to Training Coordinator/Committee approval. This program begins fall semester.

See back of this guide for Course Sequence

Minimum Program Entry Requirements

Students entering this program must meet the following minimum program entry requirements:

Reading Comprehension: Score of 85+

Arithmetic: Score of 72 or better

Spatial: 70% or better

Students must maintain a GPA of 2.5 to continue in the program.

Students are accepted through St. Paul Pipefitters Local 455 JACT; 651.455.5282 or www.local455jatc.com.

305D

*Information is subject to change.
This Program Requirements Guide is not a contract.*

Pipefitting Apprenticeship Building Trades DIPLOMA *(continued)*

Course Sequence

The following sequence is subject to Training Coordinator/Committee approval. This program begins fall semester.

1st year - Fall

RWLD 2621 Apprentice Pipe Weld 1	2
PIPE 2658 OSHA30/Pro10/UA Heritage	2

1st year - Spring

RWLD 2660 Apprentice Pipe Weld 1 Advanced	2
PIPE 2615 Pipe Layout & Installation 1	2

2nd year - Fall

RWLD 2622 Apprentice Pipe Weld 2	2
PIPE 2616 Pipe Layout & Installation 2	2

2nd year - Spring

RWLD 2661 Apprentice Pipe Weld 2 Advanced	2
PIPE 2660 Industrial Rigging	2

3rd year - Fall

RWLD 2623 Apprentice Pipe Weld 3	2
PIPE 2625 Steam, Hot Water & Gas Controls	2

3rd year - Spring

RWLD 2662 Apprentice Pipe Weld 3 Advanced	2
Plus one of the following:	
PIPE 2631 Industrial Pneumatics	2
PIPE 2606 Pipefitting 2	2

4th year - Fall

RWLD 2624 Apprentice Pipe Weld 4	2
PIPE 2642 Piping Design	2

4th year - Spring

RWLD 2663 Apprentice Pipe Weld 4 Advanced	2
PIPE 2641 Foreman Leadership	2

5th year - Fall

PIPE 2655 Ammonia Code	2
PIPE 2656 High Pressure Steam Code	2

5th year - Spring

PIPE 2653 Gas Code	1
PIPE 2651 Refrigeration Code	1
PIPE 2652 Oil Code	1
PIPE 2654 Hot Water Code	1

Any combination of the following courses also fulfills the program requirements with Training Coordinator or Committee approval:

PIPE 2614 Boiler Systems	2
PIPE 2661 Pipefitting for HVAC	2
PIPE 2623 Refrigeration/AC	2
PIPE 2626 Basic Service Applications	2
PIPE 2627 Basic Electricity	2
PIPE 2628 Commercial Pneumatics	2
PIPE 2632 Commercial Refrigeration	2
PIPE2636 Electrical Controls/Diagrams	2
PIPE 2638 Computer Controls	2
PIPE 2639 Steam, Hot Water & Gas Controls	2
PIPE 2642 Piping Design	2
PIPE 2643 Start/Test/Balance of Systems	2
PIPE 2644 Power Burners & Controls	2
PIPE 2643 Start/Test/Balance of Systems	2
PIPE 2645 DDC	2
PIPE 2657 Advanced Boiler Systems	2
PIPE 2659 Commercial Building Systems	2
PIPE 2657 Advanced Boiler Systems	2
PIPE 2659 Commercial Building Systems	2

Pipefitting Apprenticeship Service DIPLOMA

Program Overview

HVACR Technicians install, maintain, and repair high and low pressure steam systems, high and low pressure hot water systems, snow melting systems, refrigeration systems, heating, gas and oil piping, pneumatic, electronic controls, air conditioning and also provide instrumentation and valve repair. These skills are used working in residential, commercial, and industrial installations. These systems are installed in all types of weather conditions.

Applicants must be high school graduates or the equivalent and have completed an accredited two-year HVACR program or equivalent. HVACR Technicians must have a clean driving record and be able to pass job site specific drug testing. HVACR Technicians spend a lot of time outside in extreme weather and are often under stress to get a piece of mechanical equipment back on line. There may be times when an HVACR Technician is required to perform heavy lifting.

Career Opportunities

HVACR Technicians work in all aspects of the heating, air conditioning, refrigeration, and temperature control fields. We are employed at oil refineries, chemical plants, food processing facilities, manufacturing plants, retail and wholesale food stores, and ice rinks.

The University of Minnesota, Saint Paul School District, Metropolitan Council, Saint Paul Government Center, and Energy Park also employ maintenance HVACR Technicians to keep their systems on line.

We have pipefitters installing and maintaining refrigeration trucks, trailers, and buses at Thermo King Sales and Service.

Program Outcomes

1. Graduates will have the science and math skills needed in the piping systems.
2. Graduates will have the basic knowledge and skills necessary to install piping systems in commercial and industrial buildings.
3. Graduates will have basic knowledge to properly install and operate low- and high-pressure steam systems.

Transfer Opportunities

Saint Paul College has a transfer articulation agreement between the following program and post-secondary institution for the baccalaureate degree program listed below.

For more information please go to saintpaul.edu/Transfer.

Pipefitting Apprenticeship Service Diploma
 BS Operations Management
 Minnesota State University, Moorhead

Program Faculty

Bill Lombard Training Coordinator
 bill.lombard@local455jatc.com

Program Requirements

Check off when completed

Course	Cr
<input type="checkbox"/> PIPE 2614 Boiler Systems	2
<input type="checkbox"/> PIPE 2615 Pipe Layout & Installation 1.	2
<input type="checkbox"/> PIPE 2623 Apprenticeship Refrigeration/AC	2
<input type="checkbox"/> PIPE 2626 Basic Service Applications.	2
<input type="checkbox"/> PIPE 2627 Basic Electricity	2
<input type="checkbox"/> PIPE 2628 Commercial Pneumatics	2
<input type="checkbox"/> PIPE 2632 Commercial Refrigeration	2
<input type="checkbox"/> PIPE 2636 Electrical Controls/Diagrams.	2
<input type="checkbox"/> PIPE 2638 Computer Controls	2
<input type="checkbox"/> PIPE 2642 Piping Design	2
<input type="checkbox"/> PIPE 2643 Start/Test/Balance of Systems.	2
<input type="checkbox"/> PIPE 2644 Power Burners & Controls.	2
<input type="checkbox"/> PIPE 2645 DDC	2
<input type="checkbox"/> PIPE 2651 Refrigeration Code	1
<input type="checkbox"/> PIPE 2652 Oil Code	1
<input type="checkbox"/> PIPE 2653 Gas Code.	1
<input type="checkbox"/> PIPE 2654 Hot Water Code	1
<input type="checkbox"/> PIPE 2655 Ammonia Code	2
<input type="checkbox"/> PIPE 2656 High Pressure Steam Code	2
<input type="checkbox"/> PIPE 2657 Advanced Boiler Systems	2
<input type="checkbox"/> PIPE 2658 OSHA30/Pro10/UA Heritage	2
<input type="checkbox"/> PIPE 2659 Commercial Building Systems.	2
Total Program Credits	40

Special Features

Students are employed by contractors who are signatory with UA Local Union 455 St. Paul Pipefitters.

Restricted Enrollment

The Pipefitting Apprenticeship Service Diploma is a restricted enrollment joint program offered through the St. Paul Pipefitters Local 455 and Saint Paul College. Admission to the Pipefitters Apprenticeship program is required for enrollment in this program. Call 651.455.5282 for application information.

Course Sequence

The following sequence is subject to Training Coordinator/Committee approval. This program begins fall semester.

See back of this guide for Course Sequence

Minimum Program Entry Requirements

Students entering this program must meet the following minimum program entry requirements:

Reading Comprehension: Score of 85+

Arithmetic: Score of 72 or better

Spatial: 70% or better

Students must maintain a GPA of 2.5 to continue in the program.

Students are accepted through St. Paul Pipefitters Local 455 JACT; 651.455.5282 or www.local455jatc.com.

306D

*Information is subject to change.
 This Program Requirements Guide is not a contract.*

Pipefitting Apprenticeship Service DIPLOMA *(continued)*

Course Sequence

The following sequence is subject to Training Coordinator/Committee approval. This program begins fall semester.

1st year-Fall

PIPE 2658 OSHA 30/Pro10/UA Heritage/Standard for Excellence 2
 PIPE 2615 Pipe Layout & Inst 2

1st year-Spring

PIPE 2627 Basic Electricity 2
 PIPE 2623 Apprenticeship Refrigeration/AC 2

2nd year-Fall

PIPE 2628 Commercial Pneumatics 2
 PIPE 2636 Electrical Controls/Diagrams 2

2nd year-Spring

PIPE 2659 Commercial Building Systems 2
 PIPE 2626 Basic Service Applications 2

3rd year-Fall

PIPE 2614 Boiler Systems 2
 PIPE 2657 Boiler Systems Advanced 2

3rd year-Spring

PIPE 2638 Computer Controls 2
 PIPE 2632 Commercial Refrigeration 2

4th year-Fall

PIPE 2642 Piping Design 2
 PIPE 2644 Oil Burners/Controls 2

4th year-Spring

PIPE 2643 Start/Test/Balance 2
 PIPE 2645 DDC 2

5th year-Fall

PIPE 2655 Ammonia Code 2
 PIPE 2656 High Pressure Steam Code 2

5th year-Spring

PIPE 2653 Gas Code 1
 PIPE 2651 Refrigeration Code 1
 PIPE 2652 Oil Code 1
 PIPE 2654 Hot Water Code 1

Any combination of the following courses also fulfills the program requirements with Training Coordinator or Committee approval:

PIPE 2606 Pipefitting 2 2
 PIPE 2615 Pipe Layout & Installation 1 2
 PIPE 2616 Pipe Layout & Installation 2 2
 PIPE 2625 Steam, Hot Water & Gas Controls 2
 PIPE 2631 Industrial Pneumatics 2
 PIPE 2641 Foreman Leadership 1
 PIPE 2660 Industrial Rigging 2
 RWLD 2621 Apprentice Pipe Weld 1 2
 RWLD 2622 Apprentice Pipe Weld 2 2
 RWLD 2623 Apprentice Pipe Weld 3 2
 RWLD 2624 Apprentice Pipe Weld 4 2
 RWLD 2660 Apprentice Pipe Weld 1 Advanced 2
 RWLD 2661 Apprentice Pipe Weld 2 Advanced 2
 RWLD 2662 Apprentice Pipe Weld 3 Advanced 2
 RWLD 2663 Apprentice Pipe Weld 4 Advanced 2

Plumbing DIPLOMA

Program Overview

The Plumbing program trains apprentices in commercial, residential and industrial plumbing.

Plumbers install and maintain the water, waste disposal, soil and vent, drainage and gas systems in homes and in commercial and industrial buildings. Plumbers also install faucets, bathtubs, sinks and toilets, and such appliances as dishwashers and water heaters. Plumbers often work from blueprints and specifications and are knowledgeable about building and plumbing codes which govern installations.

Applicants must be high school graduates or equivalent. High school courses in mathematics, science, mechanical drawing and wood or metal shop will be helpful.

Career Opportunities

According to the U.S. Department of Labor, employment of plumbers is expected to grow as fast as the average for all occupations.

Before becoming a journeyman plumber, the apprentice must pass the Minnesota State Plumbing Examination. Licensing is by the State Board of Health.

Program Outcomes

1. Graduates will demonstrate safe and proper use of tools used in the plumbing field.
2. Graduates will have knowledge and skills to install piping in commercial, residential and industrial buildings.
3. Graduates will demonstrate knowledge in blueprint reading.
4. Graduates will demonstrate knowledge in code and proper installation practices.
5. Graduates will demonstrate science and math skills needed in the plumbing field.

Transfer Opportunities

Saint Paul College has a transfer articulation agreement between the following program and post-secondary institution for the baccalaureate degree program listed below.

For more information please go to saintpaul.edu/Transfer.

Plumbing Diploma

BS Operations Management
Minnesota State University, Moorhead

*Information is subject to change.
This Program Requirements Guide is not a contract.*

Program Faculty

Adjunct faculty members, who are experienced in plumbing and represent private practice, local government, and industry sectors.

Program Requirements

Check off when completed

Certain classes must be taken concurrently and certain classes are prerequisites to other classes.

Course	Cr
<input type="checkbox"/> PLMB 2610 Pre-Apprentice Plumbing	2
<input type="checkbox"/> PLMB 2612 Job Safety & Health	2
<input type="checkbox"/> PLMB 2614 Applied Math for Plumbing	4
<input type="checkbox"/> PLMB 2616 Plumbing Welding	4
<input type="checkbox"/> PLMB 2618 Basic Drawing	4
<input type="checkbox"/> PLMB 2621 Plumbing 1	4
<input type="checkbox"/> PLMB 2622 Plumbing 2	4
<input type="checkbox"/> PLMB 2623 Plumbing 3 Gas Installations and Gas Controls OR PLMB 2650 Industrial Plumbing	4
<input type="checkbox"/> PLMB 2624 Plumbing 4 Commercial and Residential Service	4
<input type="checkbox"/> PLMB 2640 Advanced Plan Reading and Heavy Rigging	4
<input type="checkbox"/> PLMB 2631 Plumbing Code 1	2
<input type="checkbox"/> PLMB 2632 Plumbing Code 2	2
<input type="checkbox"/> PLMB 2633 Plumbing Code 3	2
<input type="checkbox"/> PLMB 2634 Plumbing Code 4	2

Total Program Credits 44

Program Start Dates

This part-time, evening program starts each spring. Please check with Rick Gale, Program Coordinator, at 651.846.1389 for information on application deadlines for this program.

Restricted Enrollment

The Plumbing Diploma program is a restricted enrollment program offered through the Plumbers and Gasfitters Local 34 and Saint Paul College. Admission to the Plumbing Apprenticeship program is required for enrollment in this diploma program. Those enrolled in the Plumbing Diploma program are subject to the St. Paul Plumbers & Gasfitters Apprenticeship Standards, as well as the Saint Paul College Student Code of Conduct and Academic Integrity Policy. Violations of these standards or policies may result in removal from both the apprenticeship program and the plumbing diploma classes. Concurrent enrollment in both the apprenticeship program and plumbing classes is required.

Contact Rick Gale at 651.846.1389 for application information.

Course Sequence

Spring Semester

Students must complete the Pre-Apprenticeship classes (PLMB 2610 and PLMB 2612) prior to work eligibility.

PLMB 2610 Pre-Apprentice Plumbing	2
PLMB 2612 Job Safety and Health	2

1st Year Apprentice

PLMB 2614 Applied Math for Plumbers	4
-------------------------------------	---

2nd Year Apprentice

PLMB 2622 Plumbing 2	4
----------------------	---

3rd Year Apprentice

PLMB 2623 Plumbing 3 Gas Installations and Gas Controls OR PLMB 2650 Industrial Plumbing	4
---	---

4th year Apprentice

PLMB 2640 Advanced Plan Reading and Heavy Rigging	4
---	---

5th Year Apprentice

PLMB 2633 Plumbing Code 3	2
PLMB 2634 Plumbing Code 4	2

Fall Semester

1st Year Apprentice

PLMB 2621 Plumbing 1	4
----------------------	---

2nd Year Apprentice

PLMB 2616 Plumbing Welding	4
----------------------------	---

3rd year Apprentice

PLMB 2624 Plumbing 4 Commercial and Residential Service	4
---	---

4th Year Apprentice

PLMB 2618 Basic Drawing	4
-------------------------	---

5th Year Apprentice

PLMB 2631 Plumbing Code 1	2
PLMB 2632 Plumbing Code 2	2

Total Program Credits 44

Minimum Program Entry Requirements

Students entering this program must meet the following minimum program entry requirements:

Reading: Score of 74+

Writing: Any

Arithmetic: Score of 49+

Spatial assessment required: Score of 50+

Assessment Results and Prerequisites:

Students admitted into Saint Paul College programs may need to complete additional courses based on assessment results and course prerequisite requirements. Certain MATH, READ, and ENGL courses have additional prerequisites.

097D (7036)

Sheet Metal-HVAC Ducts and Fittings AAS DEGREE

Program Overview

The sheet metal worker reads blueprints, prepares layouts and operates fabricating devices such as special hand tools, power shears, nibbler, brake, bar folder, turning machines, spot and arc welders, soldering equipment and plasma cutting systems. The skilled sheet metal worker gathers general information and specifications from blueprints for the fabrication and installation of ducts for heating, cooling, filtering and humidifying air. Also, sheet metal workers fabricate and install metal roofing and siding, stainless steel equipment for homes and industry, chutes for material transfer, signs and rain dispersal equipment. Satisfactory preparation for the sheet metal program may include high school courses in algebra and geometry. Other helpful courses are mechanical drafting and metal shop. Much of the sheet metal work starts with two-dimensional objects and ends with a three-dimensional product. Sheet metal work requires good spatial perception.

Career Opportunities

According to the U.S. Department of Labor, employment of sheet metal workers in construction is expected to increase about as fast as the average for all occupations. Graduates may go to work for firms that fabricate sheet metal products and become skilled production, precision, or construction sheet metal workers.

Program Outcomes

1. Graduates will have the knowledge and skills to layout, fabricate, and assemble all types of sheet metal products.
2. Graduates will have the ability to safely operate all types of sheet metal fabricating equipment.
3. Graduates will have the knowledge and skills to complete sheet metal welding and soldering processes.
4. Graduates will have the knowledge and skills to use computer-aided drafting for the design and fabrication of sheet metal products.
5. Graduates will have the knowledge and skills to use drafting and blueprint reading to design HVAC duct systems.

Transfer Opportunities

Saint Paul College has a transfer articulation agreement between the following program and post-secondary institutions for the baccalaureate degree programs listed below. For more information please go to saintpaul.edu/Transfer.

Sheet Metal/HVAC Ducts & Fittings AAS

- BA Individualized Studies
Metropolitan State University
- BS Operations Management
Minnesota State University, Moorhead

Program Faculty

Viangsavanh Paborriboon
viangsavanh.paborriboon@saintpaul.edu
651.846.1367

Program Requirements

Check off when completed

Special supplies, tools, and estimated costs

The list for required tools is supplied by the program advisor. The cost of tools for the program is approximately \$300. Contact program faculty for more information.

Course	Cr
<input type="checkbox"/> SMET 1410 Sheet Metal Fitting Layout and Design	4
<input type="checkbox"/> SMET 1415 OSHA 30 HR Training	2
<input type="checkbox"/> SMET 1420 Sheet Metal Fitting Fabrication	4
<input type="checkbox"/> SMET 1430 Sheet Metal Drafting & Blueprint Reading	2
<input type="checkbox"/> SMET 1440 Sheet Metal Welding	5
<input type="checkbox"/> SMET 1450 Sheet Metal Practical Problem Solving	2
<input type="checkbox"/> SMET 1510 Duct System Layout & Design	4
<input type="checkbox"/> SMET 1520 Duct System Fabrication	4
<input type="checkbox"/> SMET 1530 Architectural Sheet Metal	4
<input type="checkbox"/> SMET 1540 Power Machine Operation	3
<input type="checkbox"/> SMET 1550 Sheet Metal CAD/CAM Systems	3
Subtotal	37

General Education/MnTC Requirements Cr

- Refer to the Minnesota Transfer Curriculum Course List for each Goal Area
- Goal 1: Communication7
ENGL 1711 Composition 1 – 4 cr
COMM 17XX – 3 cr
 - Goal 3 or Goal 46
Goal 3: Natural Sciences OR
Goal 4: Mathematical/Logical Reasoning
 - Goal 5: History, Social Science and Behavioral Sciences3
 - Goal 6: Humanities and Fine Arts.3
Select a minimum of 4 additional credits
 - Goals 1 – 10 of the Minnesota Transfer Curriculum. . .4
Select a minimum of 4 additional credits

General Education Requirements 23
General Education requirement courses may be taken before, after or concurrently with Sheet Metal courses.

Total Program Credits 60

*Information is subject to change.
This Program Requirements Guide is not a contract.*

Program Start Dates

Fall

Full-time enrollment is required

Students must be enrolled full-time with a cohort of students. Technical courses only offered during days.

Course Sequence

The following sequence is recommended.

First Semester

SMET 1410 Sheet Metal Fitting Layout and Design	4
SMET 1415 OSHA 30 HR Training	2
SMET 1420 Sheet Metal Fitting Fabrication	4
SMET 1430 Sheet Metal Drafting & Blueprint Reading	2
SMET 1440 Sheet Metal Welding	5
SMET 1450 Sheet Metal Practical Problem Solving	2
Goal 1: COMM 17XX	3
Total Semester Credits	22

Second Semester

SMET 1510 Duct System Layout & Design	4
SMET 1520 Duct System Fabrication	4
SMET 1530 Architectural Sheet Metal	4
SMET 1540 Power Machine Operation	3
SMET 1550 Sheet Metal CAD/CAM Systems	3
Total Semester Credits	18

General Education Requirements (20 additional credits)

Total Program Credits 60

Minimum Program Entry Requirements

Students entering this program must meet the following minimum program entry requirements:

Reading: Score of 60+ or grade of "C" or better in READ 0721

Writing: Score of 60+ or grade of "C" or better in ENGL 0921

Arithmetic: Score of 31+

Spatial assessment required: Score 50+ on spatial assessment

Assessment Results and Prerequisites: Students admitted into Saint Paul College programs may need to complete additional courses based on assessment results and course prerequisite requirements. Certain MATH, READ, and ENGL courses have additional prerequisites.

368A

Sheet Metal-HVAC Ducts and Fittings DIPLOMA

Program Overview

The sheet metal worker reads blueprints, prepares layouts, and operates fabricating devices such as special hand tools, power shears, nibbler, brake, bar folder, turning machines, spot and arc welders, soldering equipment, and plasma cutting systems. The skilled sheet metal worker gathers general information and specifications from blueprints for the fabrication and installation of ducts for heating, cooling, filtering, and humidifying air. Also, sheet metal workers fabricate and install metal roofing and siding, stainless steel equipment for homes and industry, chutes for material transfer, signs, and rain dispersal equipment.

Satisfactory preparation for the sheet metal program may include high school courses in algebra and geometry. Other helpful courses are mechanical drafting and metal shop. Much of the sheet metal work starts with two-dimensional objects and ends with a three-dimensional product. Sheet metal work requires good spatial perception.

Career Opportunities

According to the U.S. Department of Labor, employment of sheet metal workers in construction is expected to increase about as fast as the average for all occupations. Graduates may go to work for firms that fabricate sheet metal products and become skilled production, precision, or construction sheet metal workers.

Program Outcomes

1. Graduates will have the knowledge and skills to layout, fabricate, and assemble all types of sheet metal products.
2. Graduates will have the ability to safely operate all types of sheet metal fabricating equipment.
3. Graduates will have the knowledge and skills to complete sheet metal welding and soldering processes.
4. Graduates will have the knowledge and skills to use computer-aided drafting for the design and fabrication of sheet metal products.
5. Graduates will have the knowledge and skills to use drafting and blueprint reading to design HVAC duct systems.

Transfer Opportunities

Saint Paul College has a transfer articulation agreement between the following program and post-secondary institution for the baccalaureate degree program listed below.

For more information please go to saintpaul.edu/Transfer.

Sheet Metal-HVAC Ducts and Fittings Diploma

BS Operations Management
Minnesota State University, Moorhead

Program Faculty

Viangsavanh Paborriboon
viangsavanh.paborriboon@saintpaul.edu
651.846.1367

Special supplies, tools, and estimated costs

The list for required tools is supplied by the program advisor. The cost of tools for the program is approximately \$300. Contact program faculty for more information.

Program Requirements

Check off when completed

Course	Cr
<input type="checkbox"/> SMET 1410 Sheet Metal Fitting Layout and Design	4
<input type="checkbox"/> SMET 1415 OSHA 30 HR Training	2
<input type="checkbox"/> SMET 1420 Sheet Metal Fitting Fabrication	4
<input type="checkbox"/> SMET 1430 Sheet Metal Drafting & Blueprint Reading	2
<input type="checkbox"/> SMET 1440 Sheet Metal Welding	5
<input type="checkbox"/> SMET 1450 Sheet Metal Practical Problem Solving	2
<input type="checkbox"/> SMET 1510 Duct System Layout & Design	4
<input type="checkbox"/> SMET 1520 Duct System Fabrication	4
<input type="checkbox"/> SMET 1530 Architectural Sheet Metal	4
<input type="checkbox"/> SMET 1540 Power Machine Operation	3
<input type="checkbox"/> SMET 1550 Sheet Metal CAD/CAM Systems	3
Subtotal	37

General Education/MnTC Requirements

Refer to the Minnesota Transfer Curriculum Course List for each Goal Area

<input type="checkbox"/> Goal 1: Communication	3
COMM 17XX – 3 cr	
General Education Requirements	3

Total Program Credits **40**

Program Start Dates

Fall

Full-time enrollment is required

Students must be enrolled full-time with a cohort of students. Technical courses only offered during days.

Course Sequence

The following sequence is recommended.

First Semester

SMET 1410 Sheet Metal Fitting Layout and Design	4
SMET 1415 OSHA 30 HR Training	2
SMET 1420 Sheet Metal Fitting Fabrication	4
SMET 1430 Sheet Metal Drafting & Blueprint Reading	2
SMET 1440 Sheet Metal Welding	5
SMET 1450 Sheet Metal Practical Problem Solving	2
Goal 1: COMM 17XX	3
Total Semester Credits	22

Second Semester

SMET 1510 Duct System Layout & Design	4
SMET 1520 Duct System Fabrication	4
SMET 1530 Architectural Sheet Metal	4
SMET 1540 Power Machine Operation	3
SMET 1550 Sheet Metal CAD/CAM Systems	3
Total Semester Credits	18

Total Program Credits **40**

Minimum Program Entry Requirements

Students entering this program must meet the following minimum program entry requirements:

Reading: Score of 60+ or grade of "C" or better in READ 0721

Writing: Score of 38+

Arithmetic: Score of 31+

Spatial assessment required: Score 50+ on spatial assessment

Assessment Results and Prerequisites:

Students admitted into Saint Paul College programs may need to complete additional courses based on assessment results and course prerequisite requirements. Certain MATH, READ, and ENGL courses have additional prerequisites.

368D

*Information is subject to change.
This Program Requirements Guide is not a contract.*

Welding Technology CERTIFICATE

Program Overview

Welding is a common method for joining two pieces of metal together. This is a skill that is required throughout manufacturing and the construction trades. Entry level welders are required to be experienced in common welding methods and set-up procedures. Additionally, they will need to read blueprint drawings to create product, use various measuring devices efficiently, and be able to identify various metals that may be welded on.

Physical Requirements include good eyesight, good hand and eye coordination and the ability to perform heavy, physical work.

Career Opportunities

According to the U.S. Department of Labor, it is projected within the next 10 years to see a 15% growth rate, adding 50,000 new jobs.

In manufacturing, welders are needed in Aerospace, Structural, Precision Sheet Metal, Architectural, and many other industries. Welders are also needed in various construction trades: such as Pipefitting, Sheet Metal, Ironworker, and others.

Program Outcomes

1. Identify correct welding techniques for multiple processes.
2. Follow safety requirements in set-up, operation, and break down of metal shop equipment.
3. Produce weldments to AWS/Industry standards for multiple processes.
4. Analyze the quality of welds to determine if proper techniques/settings are being used.
5. Use blueprints and measuring devices to aid in welding.

Transfer Opportunities

Saint Paul College has a transfer articulation agreement between the following program and post-secondary institution for the baccalaureate degree program listed below.

For more information please go to saintpaul.edu/Transfer.

Welding Technology Diploma

BS Operations Management
Minnesota State University, Moorhead

Program Faculty

Todd Hankel todd.hankel@saintpaul.edu
Victoria LeMay victoria.lemay@saintpaul.edu
Caleb Paulson caleb.paulson@saintpaul.edu

Supply costs

Estimated cost for student supplies \$250.

Program Requirements

Check off when completed

Certain classes must be taken concurrently and certain classes are prerequisites to other classes.

Course	Cr
<input type="checkbox"/> WLDG 1402 Industrial Shop Practices 1	4
<input type="checkbox"/> WLDG 1410 Welding Basics	2
<input type="checkbox"/> WLDG 1420 SMAW: E6010	2
<input type="checkbox"/> WLDG 1431 SMAW: E7018	2
<input type="checkbox"/> WLDG 1441 GMAW: Short Arc	3
<input type="checkbox"/> WLDG 1450 Intro to Blueprint/Measuring Devices	3

Total Program Credits16

Program Start Dates

Fall, Spring

Course Sequence

The following sequence is recommended for a full-time student.

First Semester

WLDG 1402 Industrial Shop Practices 1	4
WLDG 1410 Welding Basics	2
WLDG 1420 SMAW: E6010	2
WLDG 1431 SMAW: E7018	2
WLDG 1441 GMAW: Short Arc	3
WLDG 1450 Intro to Blueprint/Measuring Devices	3
Total Semester Credits	16

Total Program Credits16

Minimum Program Entry Requirements

Students entering this program must meet the following minimum program entry requirements:

Reading: Score of 60+ or grade of "C" or better in READ 0721

Writing: Score of 38+

Arithmetic: Score of 31+

Assessment Results and Prerequisites: Students admitted into Saint Paul College programs may need to complete additional courses based on assessment results and course prerequisite requirements. Certain MATH, READ, and ENGL courses have additional prerequisites.

Degree option may have a greater requirement than this diploma.

312C

*Information is subject to change.
This Program Requirements Guide is not a contract.*

Welding Technology DIPLOMA

Program Overview

Welding and fabrication operations require skilled workers who are well-trained in the use of advanced arc welding process, layout fabrication techniques, blueprint reading and measuring devices. Skilled welding fabricators are thoroughly familiar with both welding and shop equipment, understanding the breakdown and setup procedures, test standards, and knowledge of the various types of metals. Physical requirements include good eyesight, good hand and eye coordination and the ability to perform heavy, physical work.

Career Opportunities

According to the U.S. Department of Labor, it is projected within the next 10 years to see a 15% growth rate, adding 50,000 new jobs. Welders and fabricators work in manufacturing plants both in structural and non-structural settings as production welders, maintenance welders, specialty welders, layout fabricators, press brake operators, CNC plasma/laser cutting operators, and robotic welding operators. Welding fabrication is widely used in the aircraft, automobile, trucking, shipbuilding, pipefitting, plumbing, sheetmetal, ironworking and other trades that use metals. Skilled welders may become layout specialists, engineers, technicians, supervisors, Certified Welding Inspectors or private shop owners.

Program Outcomes

1. Identify correct welding techniques for multiple processes.
2. Follow safety requirements in the set-up, operation, and break down of metal shop equipment.
3. Produce weldments to AWS/Industry standards for multiple processes.
4. Analyze the quality of welds to determine if proper techniques/settings are being used.
5. Use blueprints and measuring devices to aid in welding.
6. Distinguish between the characteristics of commonly used metal types.
7. Apply mathematical tools to metalworking techniques.
8. Construct projects using metalworking fabrication techniques.

Transfer Opportunities

Saint Paul College has a transfer articulation agreement between the following program and post-secondary institution for the baccalaureate degree program listed below. For more information please go to saintpaul.edu/Transfer.

Welding Technology Diploma

BS Operations Management
Minnesota State University, Moorhead

Program Faculty

Todd Hankel todd.hankel@saintpaul.edu
Victoria LeMay victoria.lemay@saintpaul.edu
Caleb Paulson caleb.paulson@saintpaul.edu

Supply costs

Estimated cost for student supplies \$520.

Program Requirements

Check off when completed

Certain classes must be taken concurrently and certain classes are prerequisites to other classes.

Course	Cr
<input type="checkbox"/> WLDG 1402 Industrial Shop Practices 1	4
<input type="checkbox"/> WLDG 1410 Welding Basics	2
<input type="checkbox"/> WLDG 1420 SMAW: E6010	2
<input type="checkbox"/> WLDG 1431 SMAW: E7018	2
<input type="checkbox"/> WLDG 1441 GMAW: Short Arc	3
<input type="checkbox"/> WLDG 1450 Intro to Blueprint/Measuring Devices	3
<input type="checkbox"/> WLDG 1502 Industrial Shop Practices	4
<input type="checkbox"/> WLDG 1510 GMAW Spray and Pulse Spray	3
<input type="checkbox"/> WLDG 1520 GMAW Core Wires	3
<input type="checkbox"/> WLDG 1530 Intro to GTAW	3
<input type="checkbox"/> WLDG 1540 Blueprint Welding Symbols/Math/Welder Qualification	3
<input type="checkbox"/> WLDG 2402 Industrial Shop Practices 3	4
<input type="checkbox"/> WLDG 2411 GMAW: Aluminum and Stainless Steel	3
<input type="checkbox"/> WLDG 2420 GTAW: Aluminum and Stainless Steel	4
<input type="checkbox"/> WLDG 2430 Grinding and Finishing	2
<input type="checkbox"/> WLDG 2442 Intro to Robotics	3
Subtotal	48

Total Program Credits48

Program Start Dates

Fall, Spring

Course Sequence

The following sequence is recommended for a full-time student.

First Semester

WLDG 1402 Industrial Shop Practices 1	4
WLDG 1410 Welding Basics	2
WLDG 1420 SMAW: E6010	2
WLDG 1431 SMAW: E7018	2
WLDG 1441 GMAW: Short Arc	3
WLDG 1450 Intro to Blueprint/Measuring Devices	3
Total Semester Credits	16

Second Semester

WLDG 1502 Industrial Shop Practices	4
WLDG 1510 GMAW Spray and Pulse Spray	3
WLDG 1520 GMAW Core Wires	3
WLDG 1530 Intro to GTAW	3
WLDG 1540 Blueprint Welding Symbols/Math/Welder Qualification	3
Total Semester Credits	16

Third Semester

WLDG 2402 Industrial Shop Practices 3	4
WLDG 2411 GMAW: Aluminum and Stainless Steel	3
WLDG 2420 GTAW: Aluminum and Stainless Steel	4
WLDG 2430 Grinding and Finishing	2
WLDG 2442 Intro to Robotics	3
Total Semester Credits	16

Total Program Credits48

Minimum Program Entry Requirements

Students entering this program must meet the following minimum program entry requirements:

Reading: Score of 60+ or grade of "C" or better in READ 0721

Writing: Score of 38+

Arithmetic: Score of 31+

Assessment Results and Prerequisites:

Students admitted into Saint Paul College programs may need to complete additional courses based on assessment results and course prerequisite requirements. Certain MATH, READ, and ENGL courses have additional prerequisites.

Degree option may have a greater requirement than this diploma.

324D (7187)

*Information is subject to change.
This Program Requirements Guide is not a contract.*

Robotic Welding CERTIFICATE

Program Overview

Professional fabricators and CNC operators are highly skilled individuals who excel in math, geometry, formulations, programming, critical thinking and blueprint reading. Physical requirements include good eyesight, good hand and eye coordination, standing for long periods of time and the ability to perform heavy, physical work.

Robotic welding is an exciting and growing part of the welding profession. Robotic tools can automate some high production applications, such as resistance spot welding and arc welding.

Students must be a graduate of the Welding Technology Diploma (WLDG) or have instructor approval.

Career Opportunities

Fabricators and CNC operators work in manufacturing plants as production welders, specialist welders, layout engineers, press brake and CNC operators both in structural and non-structural settings. Welding/fabricating is widely used in the aircraft, automotive, heavy equipment, sheet metal, and other trades that use fabrication and CNC equipment.

Program Outcomes

1. Graduates will have the knowledge and skills in setup and break-down procedures of CNC equipment including press brake, CNC plasma cutting and robotic welding.
2. Graduates will have knowledge and skills in sheet metal bend deduction formulation.
3. Graduates will have acquired supervised hands-on experience in using various welding and finishing processes and fabrication equipment.
4. Graduates will be prepared for employment in the welding industry and related fabrication fields.

Transfer Opportunities

Saint Paul College has a transfer articulation agreement between the following program and post-secondary institution for the baccalaureate degree program listed below.

For more information please go to saintpaul.edu/Transfer.

Robotic Welding Certificate

BA Individualized Studies
Metropolitan State University

Program Faculty

Todd Hankel todd.hankel@saintpaul.edu
Caleb Paulson caleb.paulson@saintpaul.edu

Supply Costs

Estimated cost for student supplies \$520.

Program Requirements

Students must have a Welding Diploma or instructor approval.

Check off when completed

Course	Cr
<input type="checkbox"/> WLDG 2500 2D CAD	2
<input type="checkbox"/> WLDG 2510 Safety	1
<input type="checkbox"/> WLDG 2520 CNC Plasma	2
<input type="checkbox"/> WLDG 2530 Press Brake Operations	3
<input type="checkbox"/> WLDG 2540 Robotic Welding Operations	3
<input type="checkbox"/> WLDG 2550 Industrial Equipment	2
<input type="checkbox"/> WLDG 2560 Layout Practices	4

Total Program Credits 17

Program Start Dates

Fall, Spring

Course Sequence

The following sequence is recommended for a full-time student.

First Semester

WLDG 2500 2D CAD	2
WLDG 2510 Safety	1
WLDG 2520 CNC Plasma	2
WLDG 2530 Press Brake Operations	3
WLDG 2540 Robotic Welding Operations	3
WLDG 2550 Industrial Equipment	2
WLDG 2560 Layout Practices	4
Total Semester Credits	17

Total Program Credits 17

Minimum Program Entry Requirements

Students entering this program must meet the following minimum program entry requirements:

Reading: Score of 60+ or grade of "C" or better in READ 0721

Writing: Score of 38+

Arithmetic: Score of 31+

Assessment Results and Prerequisites:

Students admitted into Saint Paul College programs may need to complete additional courses based on assessment results and course prerequisite requirements. Certain MATH, READ, and ENGL courses have additional prerequisites.

Degree option may have a greater requirement than this certificate.

350C

*Information is subject to change.
This Program Requirements Guide is not a contract.*

CNC Toolmaking DIPLOMA

Program Overview

This area produces skilled craftspeople who make precision metal parts that are highly specialized and not mass produced. Machinists produce parts from metal castings, forgings, stampings, or from solid metal stock. They make parts to exact specifications by removing excess metal with the aid of machine tools, numerically controlled machines, computer assisted machinery, and precise measuring and gauging equipment.

Career Opportunities

As the economy expands, so will the demand for manufactured goods that need machine metal parts. CNC Toolmaking graduates are hired by industries that manufacture automobiles, industrial machinery, military equipment, and other metal products. At many places of employment, graduates can apply training received at the College towards the completion of apprenticeship requirements.

Program Outcomes

1. Graduates will have the knowledge and skills to make precision-machined parts and tooling.
2. Graduates will have the knowledge and skills to program and operate CNC equipment using CAD and CAM.
3. Graduates will have the knowledge and skills to operate and set-up inspection and gauging equipment.
4. Graduates will have the knowledge and skills to meet national entry-level skills standards.
5. Graduates will have acquired shop communication skills such as blueprint reading, practical geometric dimensioning, and shop CAD/CAM skills.
6. Graduates will have successfully mastered the general education program requirements for work and life skills.
7. Graduates will use SolidWorks, design parts and collaborate with engineers.

Transfer Opportunities

Saint Paul College has a transfer articulation agreement between the following program and post-secondary institution for the baccalaureate degree program listed below.

For more information please go to saintpaul.edu/Transfer.

CNC Toolmaking Diploma

BS Operations Management
Minnesota State University, Moorhead

Program Faculty

Garrett Byrne garrett.byrne@saintpaul.edu
Ben Johnson ben.johnson@saintpaul.edu
Scott Nordahl scott.nordahl@saintpaul.edu

Estimated Cost for Student Supplies

The estimated cost for student supplies is \$850.

Program Requirements

Check off when completed

Certain classes must be taken concurrently and certain classes are prerequisites to other classes.

Course	Cr
<input type="checkbox"/> CNCT 1410 Introduction to Manufacturing Processes	4
<input type="checkbox"/> CNCT 1420 Engineering Drawings	4
<input type="checkbox"/> CNCT 1430 Materials Processes 1	4
<input type="checkbox"/> CNCT 1431 Materials Processes 2	4
<input type="checkbox"/> CNCT 1710 Shop Calculations	2
<input type="checkbox"/> CNCT 1720 Geometric Dimensioning	2
<input type="checkbox"/> CNCT 1730 CNC 1	4
<input type="checkbox"/> CNCT 1731 CNC 2	4
<input type="checkbox"/> CNCT 1744 Metrology	4
<input type="checkbox"/> CNCT 2412 Tool Design	4
<input type="checkbox"/> CNCT 2421 Mechanical Systems/EDM	4
<input type="checkbox"/> CNCT 2431 Mold/Plastic Technology	4
<input type="checkbox"/> CNCT 2441 CNC Applications	4
<input type="checkbox"/> CNCT 2520 CAD	4
<input type="checkbox"/> CNCT 2530 CNC Lathe	4
<input type="checkbox"/> CNCT 2540 Computer Aided Manufacturing	4
Subtotal	60

General Education/MnTC Requirements Cr

Refer to the Minnesota Transfer Curriculum Course List for each Goal Area

<input type="checkbox"/> Any college level general education course	3
General Education Requirements	3

Total Program Credits 63

Program Start Dates

Fall, Spring

Course Sequence

The following sequence is recommended for a full-time student; however, this sequence is not required.

First Semester

CNCT 1410 Introduction to Manufacturing Processes	4
CNCT 1420 Engineering Drawings	4
CNCT 1430 Materials Processes 1	4
CNCT 1431 Materials Processes 2	4
CNCT 2520 CAD	4
Total Semester Credits	20

Second Semester

CNCT 1710 Shop Calculations	2
CNCT 1720 Geometric Dimensioning	2
CNCT 1730 CNC 1	4
CNCT 1731 CNC 2	4
CNCT 1744 Metrology	4
CNCT 2540 Computer Aided Manufacturing	4
Total Semester Credits	20

Summer Term

General Education Requirement (any) 3

May be taken any semester, but Summer Term is recommended.

Total Credits 3

Third Semester

CNCT 2412 Tool Design	4
CNCT 2421 Mechanical Systems/EDM	4
CNCT 2431 Mold/Plastic Technology	4
CNCT 2441 CNC Applications	4
CNCT 2530 CNC Lathe	4
Total Semester Credits	20

Total Program Credits 63

Minimum Program Entry Requirements

Students entering this program must meet the following minimum program entry requirements:

Reading: Score of 60+ or grade of "C" or better in READ 0721

Writing: Score of 38+

Arithmetic: Score of 31+

Assessment Results and Prerequisites:

Students admitted into Saint Paul College programs may need to complete additional courses based on assessment results and course prerequisite requirements. Certain MATH, READ, and ENGL courses have additional prerequisites.

249D (7120)

*Information is subject to change.
This Program Requirements Guide is not a contract.*

Machine Operator CERTIFICATE

Right Skills Now for Manufacturing

Program Overview

The Right Skills Now (for Manufacturing) certificate is designed to provide training in the following areas: Job planning, benchwork, materials, manual milling, manual turning, blue print reading, CNC milling and CNC turning. This program was designed to address the current shortage of CNC operators. Graduates from this program are prepared to enter the industry as entry-level manual and CNC machine tool production operators with minimum skills.

The Right Skills Now (for Manufacturing) certificate will introduce manufacturing workplace safety, blueprint reading, general manufacturing processes, basic production manual machining skills, and introduction to operations.

The curriculum closely aligns with standards set forth by the National Institute of Metalworking Skills (NIMS). Students may choose to apply these credits towards a CNC Toolmaking Diploma. The additional coursework will enhance the students' communication, mathematics, machining, CAD/CAM, and critical thinking skills.

Career Opportunities

Right Skills Now is a pathway of the National Association of Manufacturers (NAM)–Endorsed Manufacturing Skills Certification System, which includes nationally portable, industry-recognized certifications that are combined with for-credit education programs. These education pathways are directly aligned to career pathways in manufacturing, so students progressing through the programs earn college credit towards a degree, have an opportunity to earn a national certification with labor market value, and the hands-on technical experience to be successful on the job.

Program Outcomes

1. Students will have skills to operate computer- controlled machine tools; lathes, drills, and milling machines.
2. Graduates will acquire knowledge of workplace safety.
3. Graduates will have on the job learning opportunities through an internship.



Program Faculty

Garrett Byrne garrett.byrne@saintpaul.edu
 Ben Johnson ben.johnson@saintpaul.edu
 Scott Nordahl scott.nordahl@saintpaul.edu

Estimated Cost for Student Supplies

The estimated cost for student supplies is \$850.

Program Requirements

Check off when completed

Certain classes must be taken concurrently and certain classes are prerequisites to other classes.

Course	Cr
<input type="checkbox"/> CNCT 1410 Introduction to Manufacturing Processes	4
<input type="checkbox"/> CNCT 1420 Engineering Drawing	4
<input type="checkbox"/> CNCT 1430 Materials Processes 1	4
<input type="checkbox"/> CNCT 1431 Materials Processes 2	4
<input type="checkbox"/> CNCT 2550 Industry Internship	4

Total Program Credits 20

Program Start Dates

Fall, Spring

Course Sequence

The following sequence is recommended.

First Semester

CNCT 1410 Introduction to Manufacturing Processes	4
CNCT 1420 Engineering Drawing.	4
CNCT 1430 Materials Processes 1	4
CNCT 1431 Materials Processes 2	4
Total Semester Credits	16

Second Semester

CNCT 2550 Industry Internship*	4
Prerequisite CNCT 1410, 1420, 1430, and 1431 must be completed with a grade of "C" or better.	
Total Semester Credits.	4

Total Program Credits 20

* Students are responsible for their own transportation to and from the internship site. Internship locations may not be accessible through public transportation.

Minimum Program Entry Requirements

Students entering this program must meet the following minimum program entry requirements:

Reading: Score of 60+ or grade of "C" or better in READ 0721

Writing: Score of 38+

Arithmetic: Score of 31+

Assessment Results and Prerequisites:

Students admitted into Saint Paul College programs may need to complete additional courses based on assessment results and course prerequisite requirements. Certain MATH, READ, and ENGL courses have additional prerequisites

342C

*Information is subject to change.
 This Program Requirements Guide is not a contract.*

Individualized Studies AAS DEGREE

Program Overview

The Individualized Studies degree is a personalized degree which provides students the opportunity to fulfill a unique career goal that cannot be met through the completion of any single technical program offered by the College. An example would be the combination of a technical program (e.g. automotive technology) with technical coursework in business for those planning to open their own automotive repair business. In the first semester of the Individualized Studies degree, students work to design a degree plan that meets their individualized educational needs while also fulfilling 16 credits within the Minnesota Transfer Curriculum. Students will develop an individualized program sequence through a structured advising process with faculty and college advisor, to facilitate meeting the requirements of the AAS degree in Individualized Studies.

Career Opportunities

The Individualized Studies AAS degree is intended for students who select a unique degree that meets their career interests. Career opportunities include personally owned business, advancement to middle management, sales, and training in the area of their discipline.

Program Outcomes

1. Graduates will have designed an individualized studies learning plan that focuses on work and life goals.
2. Graduates will recognize the need for and develop an ability to engage in life-long professional development and learning.

Transfer Opportunities

Saint Paul College has a transfer articulation agreement between the following program and post-secondary institution for the baccalaureate degree program listed below.

For more information please go to saintpaul.edu/Transfer.

Individualized Studies AAS

BA Individualized Studies
Metropolitan State University

Program Dean

Career and Technical Education

Rainer Haarbusch
rainer.haarbusch@saintpaul.edu

Program Requirements

- Check off when completed

Recommended Courses Cr

- INDS 1401 Study Skills and Strategies for Individualized Studies Planning. 3
- Subtotal. 3**

Program Focus: Approved Course Plan Cr

- The specific plan will be determined after meeting with the Program Faculty or Dean. Courses will be selected from existing technical coursework on campus.
- Subtotal. 41**

General Education/MnTC Requirements Cr

- Refer to the Minnesota Transfer Curriculum Course List for each Goal Area
- Goal 1: Communication 7
ENGL 1711 Composition 1 – 4 cr
COMM 17XX – 3 cr
- Goal 3: Natural Sciences OR
Goal 4: Mathematical/Logical Reasoning. 3
- Goal 5 History, Social Science and Behavioral Sciences 3
- Goal 6: Humanities & Fine Arts 3
- General Education Requirements 16**

Total Program Credits 60

Note: Any changes or modification of the program plan must be approved by the Dean.

Program Start Dates

Fall, Spring, Summer

Course Sequence

First Semester

- INDS 1401 Study Skills and Strategies for Individualized Studies Planning. 3
- Total Semester Credits. 3**

First, Second, Third and Fourth Semesters

The specific plan will be determined after meeting with the Program Faculty or Dean. Courses will be selected from existing technical coursework on campus.

Total Program Credits 60

Minimum Program Entry Requirements

Students entering this program must meet the following minimum program entry requirements:

Reading: Score of 78+ or grade of "C" or better in READ 0722

Writing: Score of 78+ or grade of "C" or better in ENGL 0922

Arithmetic: Score of 20+

Assessment Results and Prerequisites:

Students admitted to Saint Paul College programs may need to complete additional courses based on assessment results and course prerequisite requirements. Certain MATH, READ, and ENGL courses have additional prerequisites.

9ISA

*Information is subject to change.
This Program Requirements Guide is not a contract.*

Automation Technologies CERTIFICATE

An eTECH 360° Program

Program Overview

This certificate will provide students with knowledge of manufacturing processes and plant operations, along with an advanced skill set in electronic and automotive systems. Students will engage in coursework topics of technical mathematics, introductory computer skills, print interpretation, manufacturing processes, quality control, maintenance and safety. Also included in coursework is an advanced skill set of AC/DC power, digital electronics, analog circuits, and motor controls.

Career Opportunities

The nationwide Manufacturing Skills Standards Council (MSSC) System, based upon industry-defined and federally-endorsed national standards, offers both entry-level and incumbent workers the opportunity to demonstrate that they have acquired the skills increasingly needed in the high-growth, technology-intensive jobs of the 21st century. The MSSC System awards certificates to individuals who pass any of its four Production modules: Safety; Quality Practices & Measurement; Manufacturing Processes & Production; and Maintenance Awareness and a full Certified Production Technician (CPT) Certification to those who pass all four. Students completing this Certificate will have gained the knowledge required to pass the MSSC full-certified Production Technician Certification.

According to the Manufacturing Career Network, manufacturing is the second largest industry in Minnesota, second only to educational services, healthcare and social assistance. Minnesota manufacturers employ 390,435 people, which represents 14.4 percent of total employment. Further, manufacturing jobs in the state pay wages that are approximately 8 percent higher than those paid to the rest of the workforce. These numbers are evidence that a thriving manufacturing sector is critical to the state economy.

Program Outcomes

Graduates will be able to:

1. Identify and apply appropriate safety procedures.
2. Apply knowledge and skills in electrical systems.
3. Use and understand test equipment for analysis.
4. Design, build, and troubleshoot circuits.
5. Analyze and apply specific manufacturing process procedures.
6. Identify and apply specific quality procedures.
7. Interpret symbols and blueprints accurately for a variety of projects.

Program Faculty

This program is taught by a variety of faculty from consortium schools.

Rainer Haarbusch

rainer.haarbusch@saintpaul.edu

Program Requirements

Check off when completed

Certain classes must be taken concurrently and certain classes are prerequisites to other classes.

Course	Cr
<input type="checkbox"/> CMAE 1502 Technical Math	3
<input type="checkbox"/> CMAE 1510 Print Reading	2
<input type="checkbox"/> CMAE 1550 DC Power	3
<input type="checkbox"/> CMAE 1518 Manufacturing Processes	2
<input type="checkbox"/> CMAE 1514 Safety Awareness	2
<input type="checkbox"/> CMAE 1552 AC Power	3
<input type="checkbox"/> CMAE 1506 Intro to Computers	2
<input type="checkbox"/> CMAE 1554 Digital Electronics	3
<input type="checkbox"/> CMAE 1556 Analog Circuits	3
<input type="checkbox"/> CMAE 1526 Maintenance Awareness	2
<input type="checkbox"/> CMAE 1522 Quality Practices	2
<input type="checkbox"/> CMAE 1558 Motor Controls	3

Total Program Credits 30

eTECH Programs

The eTECH programs are offered by a group of partner institutions working together integrates traditional classroom learning with partial on-site lab work for the online delivery of courses where learners can advance their skills in manufacturing and engineering, while continuing to work in their current profession. Many courses are available online. The programs are designed to offer entry-level and operator-level skills and knowledge, which prepares them for a career, instead of just an entry-level job. Because eTECH is part of the 360° consortium of two-year colleges and a four-year university, it provides a unique ability to implement seamless career pathways from secondary to two-year college to four-year university.



*Information is subject to change.
This Program Requirements Guide is not a contract.*

Program Start Date

Fall, Spring

Course Sequence

First Semester

(First 8 weeks)

CMAE 1502 Technical Math	3
CMAE 1510 Print Reading	2
CMAE 1550 DC Power	3

(Second 8 weeks)

CMAE 1518 Manufacturing Processes	2
CMAE 1514 Safety Awareness	2
CMAE 1552 AC Power	3
Total Semester Credits	15

Second Semester

(First 8 Weeks)

CMAE 1506 Intro to Computers	2
CMAE 1554 Digital Electronics	3
CMAE 1556 Analog Circuits	3

(Second 8 Weeks)

CMAE 1526 Maintenance Awareness	2
CMAE 1522 Quality Practices	2
CMAE 1558 Motor Controls	3
Total Semester Credits	15

Total Program Credits 30

Minimum Program Entry Requirements

Students entering this program must meet the following minimum program entry requirements:

Reading: Score of 52+

Writing: Any

Arithmetic: Score of 45+

Assessment Results and Prerequisites:

Students admitted into Saint Paul College programs may need to complete additional courses based on assessment results and course prerequisite requirements. Certain MATH, READ, and ENGL courses have additional prerequisites.

374C

Machine Technologist CERTIFICATE

An eTECH 360^o Program

Program Overview

This certificate will provide students with knowledge of manufacturing processes and plant operations, along with an advanced skill set in machine tool technology. Students will engage in topics of technical mathematics, introductory computer skills, print interpretation, manufacturing processes, quality control, maintenance, and safety. Also included in coursework, students will engage in topics of machine tool print reading, machine tool technology theory and lab principles, machining math, introduction to computer numerical control, and geometric dimensioning and tolerancing.

Career Opportunities

The nationwide Manufacturing Skills Standards Council (MSSC) System, based upon industry-defined and federally-endorsed national standards, offers both entry-level and incumbent workers the opportunity to demonstrate that they have acquired the skills increasingly needed in the high-growth, technology-intensive jobs of the 21st century. The MSSC System awards certificates to individuals who pass any of its four Production modules: Safety; Quality Practices & Measurement; Manufacturing Processes & Production; and Maintenance Awareness and a full Certified Production Technician (CPT) Certification to those who pass all four. Students completing this Certificate will have gained the knowledge required to pass the MSSC full-certified Production Technician Certification.

According to the Manufacturing Career Network, manufacturing is the second largest industry in Minnesota, second only to educational services, healthcare and social assistance. Minnesota manufacturers employ 390,435 people, which represents 14.4 percent of total employment. Further, manufacturing jobs in the state pay wages that are approximately 8 percent higher than those paid to the rest of the workforce. These numbers are evidence that a thriving manufacturing sector is critical to the state economy.

Program Outcomes

Graduates will be able to:

1. Identify and apply appropriate safety procedures.
2. Apply knowledge and skills to make precision-machined parts and tooling.
3. Apply knowledge and skills to operate and set-up inspection and gauging equipment.
4. Demonstrate an understanding of computer numerically controlled machining centers.
5. Analyze and apply specific manufacturing process procedures.
6. Identify and apply specific quality procedures.
7. Interpret symbols and blueprints accurately for a variety of projects.

Program Faculty

This program is taught by a variety of faculty from consortium schools.

Rainer Haarbusch

rainer.haarbusch@saintpaul.edu

Program Requirements

Check off when completed

Certain classes must be taken concurrently and certain classes are prerequisites to other classes.

Course	Cr
<input type="checkbox"/> CMAE 1502 Technical Math	3
<input type="checkbox"/> CMAE 1510 Print Reading	2
<input type="checkbox"/> CMAE 1518 Manufacturing Processes	2
<input type="checkbox"/> CMAE 1514 Safety Awareness	2
<input type="checkbox"/> CMAE 1530 Machining Math	2
<input type="checkbox"/> CMAE 1532 Machine Tool Print Reading	2
<input type="checkbox"/> CMAE 1506 Intro to Computers	2
<input type="checkbox"/> CMAE 1534 Machine Tool Technology Theory	2
<input type="checkbox"/> CMAE 1536 Machine Tool Technology Lab 1	2
<input type="checkbox"/> CMAE 1542 Geo Dimensioning and Tolerancing	2
<input type="checkbox"/> CMAE 1526 Maintenance Awareness	2
<input type="checkbox"/> CMAE 1522 Quality Practices	2
<input type="checkbox"/> CMAE 1538 Machine Tool Technology Lab 2	2
<input type="checkbox"/> CMAE 1540 Introduction to CNC	3

Total Program Credits 30

eTECH Programs

The eTECH programs are offered by a group of partner institutions working together integrates traditional classroom learning with partial on-site lab work for the online delivery of courses where learners can advance their skills in manufacturing and engineering, while continuing to work in their current profession. Many courses are available online. The programs are designed to offer entry-level and operator-level skills and knowledge, which prepares them for a career, instead of just an entry-level job. Because eTECH is part of the 360^o consortium of two-year colleges and a four-year university, it provides a unique ability to implement seamless career pathways from secondary to two-year college to four-year university.



*Information is subject to change.
This Program Requirements Guide is not a contract.*

Program Start Date

Fall, Spring

Course Sequence

First Semester

(First 8 weeks)

CMAE 1502 Technical Math	3
CMAE 1510 Print Reading	2

(Second 8 weeks)

CMAE 1518 Manufacturing Processes	2
CMAE 1514 Safety Awareness	2
CMAE 1530 Machining Math	2
CMAE 1532 Machine Tool Print Reading	2
Total Semester Credits	13

Second Semester

(First 8 Weeks)

CMAE 1506 Intro to Computers	2
CMAE 1534 Machine Tool Technology Theory	2
CMAE 1536 Machine Tool Technology Lab 1	2
CMAE 1542 Geo Dimensioning and Tolerancing	2

(Second 8 Weeks)

CMAE 1526 Maintenance Awareness	2
CMAE 1522 Quality Practices	2
CMAE 1538 Machine Tool Technology Lab 2	2
CMAE 1540 Introduction to CNC	3
Total Semester Credits	17

Total Program Credits 30

Minimum Program Entry Requirements

Students entering this program must meet the following minimum program entry requirements:

Reading: Score of 52+

Writing: Any

Arithmetic: Score of 45+

Assessment Results and Prerequisites:

Students admitted into Saint Paul College programs may need to complete additional courses based on assessment results and course prerequisite requirements. Certain MATH, READ, and ENGL courses have additional prerequisites.

360C

Machining and Automation DIPLOMA

An eTECH 360° Program

Program Overview

This diploma will provide students with a valuable skill set designed to meet the needs of the advanced manufacturing industry. Students may choose the Machining and Automation emphasis. Through coursework, the student will develop fundamental knowledge of manufacturing processes, safety, quality, machine tool technology, and automation technology.

Career Opportunities

The nationwide Manufacturing Skills Standards Council (MSSC) System, based upon industry-defined and federally-endorsed national standards, offers both entry-level and incumbent workers the opportunity to demonstrate that they have acquired the skills increasingly needed in the high-growth, technology-intensive jobs of the 21st century. The MSSC System awards certificates to individuals who pass any of its four Production modules: Safety; Quality Practices & Measurement; Manufacturing Processes & Production; and Maintenance Awareness and a full Certified Production Technician (CPT) Certification to those who pass all four. Students completing this Diploma will have gained the knowledge required to pass the MSSC full-certified Production Technician Certification.

According to the Manufacturing Career Network, manufacturing is the second largest industry in Minnesota, second only to educational services, healthcare and social assistance. Minnesota manufacturers employ 390,435 people, which represents 14.4 percent of total employment. Further, manufacturing jobs in the state pay wages that are approximately 8 percent higher than those paid to the rest of the workforce. These numbers are evidence that a thriving manufacturing sector is critical to the state economy.

Program Outcomes

Graduates will be able to:

1. Identify and apply appropriate safety procedures.
2. Apply knowledge and skills in electrical systems.
3. Apply knowledge and skills to make precision-machined parts and tooling.
4. Apply knowledge and skills to operate and set-up inspection and gauging equipment.
5. Analyze and apply specific manufacturing process procedures.
6. Identify and apply specific quality procedures.
7. Interpret symbols and blueprints accurately for a variety of projects.
8. Demonstrate effective oral and written communications.

Program Faculty

This program is taught by a variety of faculty from consortium schools.

Rainer Haarbusch

rainer.haarbusch@saintpaul.edu

Program Requirements

Check off when completed

Certain classes must be taken concurrently and certain classes are prerequisites to other classes.

Course	Cr
<input type="checkbox"/> CMAE 1502 Technical Math	3
<input type="checkbox"/> CMAE 1510 Print Reading	2
<input type="checkbox"/> CMAE 1550 DC Power	3
<input type="checkbox"/> CMAE 1518 Manufacturing Processes	2
<input type="checkbox"/> CMAE 1514 Safety Awareness	2
<input type="checkbox"/> CMAE 1552 AC Power	3
<input type="checkbox"/> CMAE 1506 Intro to Computers	2
<input type="checkbox"/> CMAE 1554 Digital Electronics	3
<input type="checkbox"/> CMAE 1556 Analog Circuits	3
<input type="checkbox"/> CMAE 1526 Maintenance Awareness	2
<input type="checkbox"/> CMAE 1522 Quality Practices	2
<input type="checkbox"/> CMAE 1558 Motor Controls	3
<input type="checkbox"/> CMAE 1530 Machining Math	2
<input type="checkbox"/> CMAE 1532 Machine Tool Print Reading	2
<input type="checkbox"/> CMAE 1534 Machine Tool Technology Theory	2
<input type="checkbox"/> CMAE 1536 Machine Tool Technology Lab 1	2
<input type="checkbox"/> CMAE 1542 Geo Dimensioning and Tolerancing	2
<input type="checkbox"/> CMAE 1538 Machine Tool Technology Lab 2	2
<input type="checkbox"/> CMAE 1540 Introduction to CNC	3
Subtotal	45
General Education	
<input type="checkbox"/> MATH 1730 College Algebra	3
<input type="checkbox"/> ENGL 1711 Composition 1	4
Total General Education	7

Total Program Credits 52

*Information is subject to change.
This Program Requirements Guide is not a contract.*

Program Start Date

Fall, Spring

Course Sequence

The following sequence is subject to Training Coordinator/Committee approval. This program begins fall semester.

See back of this guide for Course Sequence

eTECH Programs

The eTECH programs are offered by a group of partner institutions working together integrates traditional classroom learning with partial on-site lab work for the online delivery of courses where learners can advance their skills in manufacturing and engineering, while continuing to work in their current profession. Many courses are available online. The programs are designed to offer entry-level and operator-level skills and knowledge, which prepares them for a career, instead of just an entry-level job. Because eTECH is part of the 360° consortium of two-year colleges and a four-year university, it provides a unique ability to implement seamless career pathways from secondary to two-year college to four-year university.



Minimum Program Entry Requirements

Students entering this program must meet the following minimum program entry requirements:

Reading: Score of 52+

Writing: Any

Arithmetic: Score of 45+

Assessment Results and Prerequisites:

Students admitted into Saint Paul College programs may need to complete additional courses based on assessment results and course prerequisite requirements. Certain MATH, READ, and ENGL courses have additional prerequisites.

Machining and Automation DIPLOMA - An eTECH 360^o Program *(continued)*

Course Sequence

First Semester

(First 8 weeks)

CMAE 1502 Technical Math3
 CMAE 1510 Print Reading2
 CMAE 1550 DC Power3

(Second 8 weeks)

CMAE 1518 Manufacturing Processes2
 CMAE 1514 Safety Awareness2
 CMAE 1552 AC Power3
Total Semester Credits 15

Second Semester

(First 8 Weeks)

CMAE 1506 Intro to Computers2
 CMAE 1554 Digital Electronics3
 CMAE 1556 Analog Circuits3

(Second 8 Weeks)

CMAE 1526 Maintenance Awareness2
 CMAE 1522 Quality Practices2
 CMAE 1558 Motor Controls3
Total Semester Credits 15

Third Semester

(First 8 Weeks)

MATH 1730 College Algebra3
 ENGL 1711 Composition 14

(Second 8 Weeks)

CMAE 1530 Machining Math2
 CMAE 1532 Machine Tool Print Reading2
Total Semester Credits 11

Fourth Semester

(First 8 Weeks)

CMAE 1534 Machine Tool Technology Theory2
 CMAE 1536 Machine Tool Technology Lab 12
 CMAE 1542 Geo Dimensioning and Tolerancing2

(Second 8 Weeks)

CMAE 1538 Machine Tool Technology Lab 22
 CMAE 1540 Introduction to CNC3
Total Semester Credits 11

Total Program Credits52

Production Technologies CERTIFICATE

An eTECH 360° Program

Program Overview

This certificate will provide students with the training, education, and skills to build a base knowledge of manufacturing processes and plant operations, generally for entry-level positions. Graduates can use the knowledge gained in this Certificate to build upon a manufacturing career path leading to higher-level careers like Automation, Machining, and Welding. Students will engage in coursework topics of career success skills, technical mathematics, introductory computer skills, print interpretation, manufacturing processes, quality control, maintenance, and safety.

Career Opportunities

The nationwide Manufacturing Skills Standards Council (MSSC) System, based upon industry-defined and federally-endorsed national standards, offers both entry-level and incumbent workers the opportunity to demonstrate that they have acquired the skills increasingly needed in the high-growth, technology-intensive jobs of the 21st century. The MSSC System awards certificates to individuals who pass any of its four Production modules: Safety; Quality Practices & Measurement; Manufacturing Processes & Production; and Maintenance Awareness and a full Certified Production Technician (CPT) Certification to those who pass all four. Students completing the Production Technologies Certificate will have gained the knowledge required to pass the MSSC full-certified Production Technician Certification.

According to the Manufacturing Career Network, manufacturing is the second largest industry in Minnesota, second only to educational services, healthcare and social assistance. Minnesota manufacturers employ 390,435 people, which represents 14.4 percent of total employment. Further, manufacturing jobs in the state pay wages that are approximately 8 percent higher than those paid to the rest of the workforce. These numbers are evidence that a thriving manufacturing sector is critical to the state economy.

Program Outcomes

Graduates will be able to:

1. Identify and apply appropriate safety procedures.
2. Use technical mathematics to solve problems.
3. Demonstrate use of common computer software.
4. Analyze and apply specific manufacturing process procedures.
5. Identify and apply specific quality procedures.
6. Interpret symbols and blueprints accurately for a variety of projects.
7. Identify appropriate and inappropriate professional behavior.

Program Faculty

This program is taught by a variety of faculty from consortium schools.

Rainer Haarbusch

rainer.haarbusch@saintpaul.edu

Program Requirements

Check off when completed

Certain classes must be taken concurrently and certain classes are prerequisites to other classes.

Course	Cr
<input type="checkbox"/> CMAE 1502 Technical Math	3
<input type="checkbox"/> CMAE 1510 Print Reading	2
<input type="checkbox"/> CMAE 1518 Manufacturing Processes	2
<input type="checkbox"/> CMAE 1514 Safety Awareness	2
<input type="checkbox"/> CMAE 1506 Intro to Computers	2
<input type="checkbox"/> CMAE 1528 Career Success Skills	1
<input type="checkbox"/> CMAE 1526 Maintenance Awareness	2
<input type="checkbox"/> CMAE 1522 Quality Practices	2
Total Program Credits	16

eTECH Programs

The eTECH programs are offered by a group of partner institutions working together integrates traditional classroom learning with partial on-site lab work for the online delivery of courses where learners can advance their skills in manufacturing and engineering, while continuing to work in their current profession. Many courses are available online. The programs are designed to offer entry-level and operator-level skills and knowledge, which prepares them for a career, instead of just an entry-level job. Because eTECH is part of the 360° consortium of two-year colleges and a four-year university, it provides a unique ability to implement seamless career pathways from secondary to two-year college to four-year university.



*Information is subject to change.
This Program Requirements Guide is not a contract.*

Program Start Date

Fall, Spring

Course Sequence

First Semester

(First 8 weeks)

CMAE 1502 Technical Math	3
CMAE 1510 Print Reading	2

(Second 8 weeks)

CMAE 1518 Manufacturing Processes	2
CMAE 1514 Safety Awareness	2
Total Semester Credits	9

Second Semester

(First 8 Weeks)

CMAE 1506 Intro to Computers	2
CMAE 1528 Career Success Skills	1

(Second 8 Weeks)

CMAE 1526 Maintenance Awareness	2
CMAE 1522 Quality Practices	2
Total Semester Credits	7

Total Program Credits 16

Minimum Program Entry Requirements

Students entering this program must meet the following minimum program entry requirements:

Reading: Score of 52+

Writing: Any

Arithmetic: Score of 45+

Assessment Results and Prerequisites:

Students admitted into Saint Paul College programs may need to complete additional courses based on assessment results and course prerequisite requirements. Certain MATH, READ, and ENGL courses have additional prerequisites.

361C

Welding Technology CERTIFICATE

An eTECH 360^o Program

Program Overview

This certificate will provide students with knowledge of manufacturing processes and plant operations, along with an advanced skill set in welding technology and processes. Students will engage in topics of technical mathematics, introductory computer skills, print interpretation, manufacturing processes, quality control, maintenance, and safety. Also included in coursework, students will engage in topics of welding symbols, metallurgy, Plasma Arc Cutting and Air Carbon Arc Cutting (OxyFuel), Shielded Metal Arc Welding (SMAW), Gas Metal Arc Welding (GMAW) and Flux Cord Arc Welding (FCAW), and Gas Tungsten Arc Welding (GTAW).

Career Opportunities

The nationwide Manufacturing Skills Standards Council (MSSC) System, based upon industry-defined and federally-endorsed national standards, offers both entry-level and incumbent workers the opportunity to demonstrate that they have acquired the skills increasingly needed in the high-growth, technology-intensive jobs of the 21st century. The MSSC System awards certificates to individuals who pass any of its four Production modules: Safety; Quality Practices & Measurement; Manufacturing Processes & Production; and Maintenance Awareness and a full Certified Production Technician (CPT) Certification to those who pass all four. Students completing this Certificate will have gained the knowledge required to pass the MSSC full-certified Production Technician Certification. According to the Manufacturing Career Network, manufacturing is the second largest industry in Minnesota, second only to educational services, healthcare and social assistance. Minnesota manufacturers employ 390,435 people, which represents 14.4 percent of total employment. Further, manufacturing jobs in the state pay wages that are approximately 8 percent higher than those paid to the rest of the workforce. These numbers are evidence that a thriving manufacturing sector is critical to the state economy.

Program Outcomes

Graduates will be able to:

1. Identify and apply appropriate safety procedures.
2. Analyze and apply specific manufacturing process procedures.
3. Identify and apply specific quality procedures.
4. Identify and select the proper filler metal dependent on base metal to be welded.
5. Troubleshoot and solve common problems involved with everyday use of a welding machine.
6. Fabricate several different welding projects to demonstrate expected skills required by industry standards.
7. Interpret symbols and blueprints accurately for a variety of projects.

Program Faculty

This program is taught by a variety of faculty from consortium schools.

Rainer Haarbusch

rainer.haarbusch@saintpaul.edu

Program Requirements

Check off when completed

Certain classes must be taken concurrently and certain classes are prerequisites to other classes.

Course	Cr
<input type="checkbox"/> CMAE 1502 Technical Math	3
<input type="checkbox"/> CMAE 1510 Print Reading	2
<input type="checkbox"/> CMAE 1518 Manufacturing Processes	2
<input type="checkbox"/> CMAE 1562 Oxy Fuel	2
<input type="checkbox"/> CMAE 1506 Intro to Computers	2
<input type="checkbox"/> CMAE 1564 SMAW	3
<input type="checkbox"/> CMAE 1526 Maintenance Awareness	2
<input type="checkbox"/> CMAE 1570 Metallurgy	1
<input type="checkbox"/> CMAE 1566 GMAW/FCAW	3
<input type="checkbox"/> CMAE 1514 Safety Awareness	2
<input type="checkbox"/> CMAE 1560 Interpreting Symbols	2
<input type="checkbox"/> CMAE 1568 GTAW	3
<input type="checkbox"/> CMAE 1522 Quality Practices	2

Total Program Credits30

eTECH Programs

The eTECH programs are offered by a group of partner institutions working together integrates traditional classroom learning with partial on-site lab work for the online delivery of courses where learners can advance their skills in manufacturing and engineering, while continuing to work in their current profession. Many courses are available online. The programs are designed to offer entry-level and operator-level skills and knowledge, which prepares them for a career, instead of just an entry-level job. Because eTECH is part of the 360^o consortium of two-year colleges and a four-year university, it provides a unique ability to implement seamless career pathways from secondary to two-year college to four-year university.



*Information is subject to change.
This Program Requirements Guide is not a contract.*

Program Start Date

Fall, Spring

Course Sequence

First Semester

(First 8 weeks)

CMAE 1502 Technical Math	3
CMAE 1510 Print Reading	2

(Second 8 weeks)

CMAE 1518 Manufacturing Processes	2
CMAE 1562 Oxy Fuel	2
Total Semester Credits	10

Second Semester

(First 8 Weeks)

CMAE 1506 Intro to Computers	2
CMAE 1564 SMAW	3

(Second 8 Weeks)

CMAE 1526 Maintenance Awareness	2
CMAE 1570 Metallurgy	1
Total Semester Credits	8

Third Semester

(First 8 Weeks)

CMAE 1566 GMAW/FCAW	3
---------------------	---

(Second 8 Weeks)

CMAE 1514 Safety Awareness	2
CMAE 1560 Interpreting Symbols	2
Total Semester Credits	7

Fourth Semester

(First 8 Weeks)

CMAE 1568 GTAW	3
----------------	---

(Second 8 Weeks)

CMAE 1522 Quality Practices	2
Total Semester Credits	5

Total Program Credits30

Minimum Program Entry Requirements

Students entering this program must meet the following minimum program entry requirements:

Reading: Score of 52+

Writing: Any

Arithmetic: Score of 45+

Assessment Results and Prerequisites:

Students admitted into Saint Paul College programs may need to complete additional courses based on assessment results and course prerequisite requirements. Certain MATH, READ, and ENGL courses have additional prerequisites.

375C

Health Science Programs

Esthetics

Esthetician Spa AAS Degree (66 Credits)	96-97
Esthetician Advanced Practice AAS Degree (60 Credits)	98-99
Esthetician Diploma (64 Credits)	100-101
Esthetician Certificate (27 Credits)	102
Esthetics Advanced Practice Certificate (19 Credits)	103
Esthetics for Cosmetologist Certificate (12 Credits)	104
CIDESCO Readiness Certificate (30 Credits)	105

Health Information Technology and Medical Office Careers

Health Information Technology AAS Degree (64 Credits)	106-107
Healthcare Informatics AAS Degree (60 Credits)	108-109
Medical Office Professional AAS Degree (60 Credits)	110-111
Medical Coding Diploma (40 Credits)	112
Medical Office Certificate (20 Credits)	113
Healthcare Documentation Specialist Certificate (30 Credits)	114

Health Sciences

Health Sciences Broad Field AS Degree (60 Credits)	115-116
---	---------

Medical Laboratory Careers

Medical Laboratory Technician AAS Degree (72 Credits)	117-118
Phlebotomy Technician Certificate (17 Credits)	119-120

Nursing and Patient Care

Patient Care Technician AAS Degree (60 Credits)	121-122
Practical Nursing Diploma (40 Credits)	123-124
Nursing Assistant/Home Health Aide Certificate (5 Credits)	125

Pharmacy Technician

Pharmacy Technician AAS Degree (60 Credits)	126-127
Pharmacy Technician Diploma (35 Credits)	128-129

Public Health

Public Health AS Degree (60 Credits)	130-131
--	---------

Respiratory Therapist

Respiratory Therapist AAS Degree (78 Credits)	132-133
--	---------

Surgical Technology

Surgical Technology AAS Degree (60 Credits)	134-135
Sterile Processing Certificate (30 Credits)	136

Wellness and Fitness Careers

Clinical Sports Massage AAS Degree (66 Credits)	137-138
Clinical Sports Massage Certificate (23 Credits)	139
Massage Therapy Certificate (30 Credits)	140
Sport and Exercise Sciences AAS Degree (60 Credits)	141-142
Sport and Exercise Sciences Diploma (50 Credits)	143
Sport and Exercise Sciences Certificate (30 Credits)	144
Registered Yoga Teacher Certificate (16 Credits)	145

Esthetician Spa AAS DEGREE

Program Overview

Esthetician services include specialized work with skin care products, analysis of skin, skin exfoliation, massage techniques and facials. Students learn to tint brows and lashes, apply makeup, provide temporary hair removal, and use machines designed to administer skin treatments. The Esthetician Spa AAS Degree is designed for future employment in a spa/resort setting. This program also prepares the student for the CIDESCO examination.

Career Opportunities

After esthetician students complete 600 hours of skills and theory training and pass the written exam through the State designated testing service and skills certification, they are eligible for licensure through the Minnesota Board of Cosmetologist Examiners. Estheticians work in a variety of settings including salons, spas, fitness centers, as well as dermatologist, plastic surgeon's offices and hospitals. CIDESCO certification holders are able to license as an esthetician technician, certify as a massage therapist and license as a nail technician upon completion of clinic nail hours. Cross trained therapists are able to work in spas, medical offices, cruise ships and 5 star resorts. Licensure or certification exams are independent of graduation requirements.

Program Outcomes

1. Graduates will be prepared to take the esthetician skills certification.
2. Graduates will be prepared to take the Minnesota State Esthetician written exam and state law test administered through the state designated service (access through www.bceboard.state.us)
3. Graduates will have knowledge and skills in salon operations focusing on skin services.
4. Graduates will be prepared for employment as an esthetician.
5. Graduates will have knowledge in cosmetic care product ingredients.
6. Graduates will be prepared to take the CIDESCO exam.
7. Graduates can transfer credits for the baccalaureate degree.

Program Faculty

Lyubov Babina lyubov.babina@saintpaul.edu

Textbook and Supply Costs

Students should expect to spend approximately \$1900.00 for esthetics books and supplies (first semester). Tuition, college fees and books for remaining courses are not included in this cost. Items can be purchased in the College Bookstore. Be prepared to purchase all Esthetics kits with the instructor on the second day of class.

Financial aid must have been completed. In addition, there is a fee to take the Minnesota licensure exam.

Program Requirements

- Check off when completed
- Required Program Orientation**
All Cosmetology, Esthetics and Nail Technician applicants must attend a program orientation prior to enrollment as a full-time student. Please call the Clinic receptionist at 651.846.1329 to reserve your space at an orientation.

Course	Cr
<input type="checkbox"/> CHSN 1598 Body Systems & Diseases (online) . . .	4
<input type="checkbox"/> CHSN 1599 Preclinic Introduction (online)	4
<input type="checkbox"/> COSM 1603 Preclinic Nail Care	3
<input type="checkbox"/> ESTH 1645 Cosmetic Chemistry & Makeup Applications	4
<input type="checkbox"/> ESTH 1650 Skin Analysis & Massage	4
<input type="checkbox"/> ESTH 1651 Clinic 1 for Estheticians	4
<input type="checkbox"/> ESTH 1652 Clinic 2 for Estheticians	4
<input type="checkbox"/> ESTH 1670 CIDESCO Exam Student Preparation	3
<input type="checkbox"/> HLTH 1410 Medical Terminology	1
<input type="checkbox"/> HLTH 1421 Anatomy & Physiology for the Somatic Practitioner	4
<input type="checkbox"/> MASS 1400 Introduction to Therapeutic Massage .	4
<input type="checkbox"/> MASS 1421 Massage Spa Techniques	2
<input type="checkbox"/> MASS 1422 Massage Clinical Techniques	4
<input type="checkbox"/> MASS 1480 Massage Therapy Practicum	4
Subtotal	49

*Information is subject to change.
This Program Requirements Guide is not a contract.*

General Education/MnTC Requirements Cr

- Refer to the Minnesota Transfer Curriculum Course List for each Goal Area
- Goal 1: Communication 7
ENGL 1711 Composition 1 – 4 cr
COMM 17XX – 3 cr
 - Goal 3: Natural Sciences 7
BIOL 1760 Nutrition – 3 cr
CHEM 1711 Principles of Chemistry 1– 4 cr
 - Goal 5: History, Social Science and Behavioral Sciences 3
General Education Requirements 17

Total Program Credits 66

Program Start Dates

- Fall, Spring
- Summer – online CHSN 1598 & CHSN 1599 only

Course Sequence

The course sequence listed on the back of this guide is recommended for a full-time student. Not all courses are offered during summer session.

Cosmetology Student Handbook/ Agreement Form

All new and returning students will need to access D2L Brightspace PRIOR to the first day of classes to read the Cosmetology student handbook. After you have read the handbook, you MUST print and sign: Student Agreement Form, Hepatitis B Vaccination/Declination Form, Property and Equipment Form, and Rollabout Form and return them to your instructor on the FIRST DAY of class before you will be admitted to class. You will need to perform this task prior to the first day of each semester. Please direct questions to the assigned instructor of your first class.

See back of this guide for Course Sequence

Minimum Program Entry Requirements

Students entering this program must meet the following minimum program entry requirements:

Reading: Score of 60+ or grade of "C" or better in READ 0721

Writing: Score of 60+ or grade of "C" or better in ENGL 0921

Arithmetic: Score of 52+ or grade of "C" or better in MATH 0745

Assessment Results and Prerequisites: Students admitted to Saint Paul College programs may need to complete additional courses based on assessment results and course prerequisite requirements. Certain MATH, READ, and ENGL courses have additional prerequisites.

344A (7/20)

CIDESCO Saint Paul College – A Community and Technical College Esthetician Program is a CIDESCO school. This means the program is allowed to prepare candidates for the CIDESCO examination. CIDESCO is the World's Major International Beauty Therapy Association:

- Founded in 1946 with its Head Office in Zurich, Switzerland.
- CIDESCO is represented in over 37 countries.
- The CIDESCO Diploma is the world's most prestigious qualification in the field of Aesthetics and Beauty Therapy.

- Since 1957, the CIDESCO qualification has set standards that have been initiated over the five continents of the globe.



Comite International d' Esthetique et de Cosmetologie
e-mail: info@cidesco.com
website: www.cidesco.com

Esthetician Spa AAS DEGREE *(continued)*

Course Sequence

The following course sequence is required. Not all courses are offered during summer session.

First Semester

CHSN 1598 Body Systems & Diseases (online)	4
<i>This course is a prerequisite to or must be taken concurrently with , ESTH 1645, ESTH 1650, ESTH 1651 and ESTH 1652</i>	
CHSN 1599 Preclinic Introduction (online)	4
<i>This course is a prerequisite to or must be taken concurrently with ESTH 1645, ESTH 1650, ESTH 1651 and ESTH 1652</i>	
ESTH 1645 Cosmetic Chemistry & Makeup Applications	4
<i>This course is a prerequisite to ESTH 1650</i>	
ESTH 1650 Skin Analysis and Massage	4
ESTH 1651 Clinic 1 for Estheticians	4
ESTH 1652 Clinic 2 for Estheticians	4
Total Semester Credits.	24

Second Semester

COSM 1603 Preclinic Nail Care	3
HLTH 1410 Medical Terminology	1
HLTH 1421 Anatomy & Physiology for the Somatic Practitioner	4
MASS 1400 Introduction to Therapeutic Massage	4
Goal 1: COMM 17XX	3
Goal 3: BIOL 1760 Nutrition	3
Total Semester Credits.	18

Third Semester

MASS 1421 Massage Spa Techniques	2
MASS 1422 Massage Clinical Techniques	4
MASS 1480 Massage Therapy Practicum	4
Total Semester Credits.	10

Fourth Semester

ESTH 1670 CIDESCO Exam Student Prep	3
<i>Offered summer semester only</i>	
Goal 1: ENGL 1711 Composition 1	4
Goal 3: CHEM 1711 Principles of Chemistry 1	4
Goal 5: History, Social Science and Behavioral Sciences	3
Total Semester Credits.	14

Total Program Credits66

Transfer Opportunities

Saint Paul College has a transfer articulation agreement between the following program and post-secondary institutions for the baccalaureate degree programs listed below.

For more information please go to saintpaul.edu/Transfer.

Esthetician Spa AAS

BA	Health Care Administration Concordia University, St. Paul
BA	Individualized Studies Metropolitan State University
BS	Healthcare and Human Service Management Saint Mary's University, Twin Cities Campus

Esthetician Advanced Practice AAS DEGREE

Program Overview

Advanced Practice (AP) Esthetics AAS degree includes the complete basic esthetics certification program, the complete AP esthetics certificate program, and the general education requirements required for completion of a two year AAS degree. AP Esthetics service include specialized training and clinical practice in four AP esthetics categories: chemical exfoliation of the skin, exfoliation of the skin using a machine or device, advanced skin care techniques, and skin needling.

The Advanced Practice Esthetics AAS Degree is designed to be the next level of training for the esthetician or cosmetologist that wishes to specialize in the afore mentioned categories including advanced understanding of skin anatomy and physiology, skin history, skin care products and ingredients, pre and post treatment regiments, client consultation including skin analysis and skin typing, and risk management. Students learn to perform chemical peels, microdermabrasion, dermaplaning, skin needling, and facials utilizing machines, electrical devices and lymphatic drainage.

Career Opportunities

After AP Esthetics students complete all theory, practical training and state testing as defined in Rule by the State of Minnesota and the Minnesota Board of Cosmetology, they are eligible for licensure through the Minnesota Board of Cosmetology. AP estheticians work in a variety of settings including salons, spas, fitness centers, medi-spas, and skin clinics. AP estheticians may also have their own Advanced Practice Esthetics business.

Final licensing and/or state testing are independent of graduation requirements.

Program Outcomes

1. Graduates will be prepared to take the basic and AP esthetics practical skills test.
2. Graduates will be prepared to take the Minnesota State basic and AP esthetics written practical, theory, and state law test administered through the Sate designated testing service (access information at <http://mn.gov/boards/cosmetology/>).
3. Graduates will have advanced knowledge and skills in AP esthetician services.
4. Graduates will possess advanced knowledge and skills for personal care of the skin.
5. Graduates will have advanced knowledge and skills in products and ingredients.
6. Graduates will have advanced knowledge and skills in licensed salon operations focusing on AP esthetics services.
7. Graduates will have the advanced knowledge and skills for work and life roles.
8. Graduates will have prepared for employment as an AP esthetician
9. Graduates will have completed general education requirements.

Program Faculty

Julie Evans julie.evans@saintpaul.edu

Textbook and Supply Costs

Students should expect to spend approximately \$1,900.00 for esthetics books and supplies (first or third semester) and \$2,000.00 for AP esthetics books and supplies (second or fourth semester). Tuition, college fees and books for remaining courses are not included in this cost. Items can be purchased in the College Bookstore. Be prepared to purchase all Esthetics kits with the instructor on the second day of class during the corresponding semester.

Financial aid must have been completed. In addition, there are fees to take the Minnesota licensure exam and obtain a Minnesota license.

Program Requirements

- Check off when completed
- Required Program Orientation**
All Cosmetology, Esthetics, Advanced Practice Esthetician, and Nail Technician applicants must attend a program orientation prior to enrollment as a full-time student. Please call the Clinic Receptionist at 651.846.1329 to reserve your space at an orientation.

Course	Cr/HR
<input type="checkbox"/> CHSN 1598 Body Systems & Diseases (online)	4/80
<input type="checkbox"/> CHSN 1599 Preclinic Introduction (online).	4/80
<input type="checkbox"/> ESTH 1645 Cosmetic Chemistry & Makeup Applications	4/80
<input type="checkbox"/> ESTH 1650 Skin Analysis & Massage	4/112
<input type="checkbox"/> ESTH 1651 Clinic 1 for Estheticians	4/128
<input type="checkbox"/> ESTH 1652 Clinic 2 for Estheticians	4/128
<input type="checkbox"/> ESTH 1710 Risk Management for Estheticians (online)	2/40
<input type="checkbox"/> ESTH 1712 Advanced Exfoliation.	4/112
<input type="checkbox"/> ESTH 1714 Advanced Skin Care Techniques	5/128
<input type="checkbox"/> ESTH 1716 Advanced Clinic 1 for Estheticians	4/128
<input type="checkbox"/> ESTH 1718 Advanced Clinic 2 for Estheticians	4/128
Subtotal.	43/1144

*Information is subject to change.
This Program Requirements Guide is not a contract.*

General Education/MnTC Requirements Cr

Refer to the Minnesota Transfer Curriculum Course List for each Goal Area

- Goal 1: Communication. 7
ENGL 1711 Composition 1 – 4 cr
COMM 1720 Interpersonal Communication - 3 cr
- Goal 3: Natural Sciences 4
CHEM 1711 Principles of Chemistry 1 – 4 cr
- Goal 5: History, Social Science and Behavioral Sciences 3
PSYC 1720 Psychology Throughout the Lifespan
- Goal 6: Humanities & Fine Arts 3
General Education Requirements 17

Total Program Credits 60

Program Start Dates

Fall, Spring
Summer – online CHSN 1598 & CHSN 1599 only

Course Sequence

The course sequence listed on the back of this guide is required.

*See back of this guide for
Course Sequence & Transfer Opportunities*

Minimum Program Entry Requirements

Students entering this program must meet the following minimum program entry requirements:

Reading: Score of 60+ or grade of "C" or better in READ 0721

Writing: Score of 60+ or grade of "C" or better in ENGL 0921

Elementary Algebra: Score of 76+ or grade of "C" or better in MATH 0910

Assessment Results and Prerequisites: Students admitted to Saint Paul College programs may need to complete additional courses based on assessment results and course prerequisite requirements. Certain MATH, READ, and ENGL courses have additional prerequisites.

Esthetician Advanced Practice AAS DEGREE *(continued)*

Course Sequence

There are two options for course sequence:

OPTION ONE

First Semester

CHSN 1598 Body Systems & Diseases
(online) 4
This course is a prerequisite to or must be taken concurrently with CHSN . . . 1599, ESTH 1645, ESTH 1650, ESTH 1651 and ESTH 1652.
May be taken the semester prior to
FIRST SEMESTER, including summer.

CHSN 1599 Preclinic Introduction (online) 4
This course is a prerequisite to or must be taken concurrently with CHSN . . . 1598, ESTH 1645, ESTH 1645, ESTH 1650, ESTH 1651 and ESTH 1652.
May be taken the semester prior to
FIRST SEMESTER, including summer.

ESTH 1645 Cosmetic Chemistry & Makeup
Applications 4
This course is a prerequisite to ESTH 1650

ESTH 1650 Skin Analysis and Massage 4
ESTH 1651 Clinic 1 for Estheticians 4
ESTH 1652 Clinic 2 for Estheticians 4
Total Semester Credits 24

Second Semester

All 17XX level classes run concurrently in the same semester. In order to register for Advanced level esthetics classes series ESTH 17XX, students must have verification of: completion of all training and passing results of all state written and practical skills testing for basic esthetics or cosmetology in accordance with Law and Rule of the Minnesota Board of Cosmetology or current/active Minnesota basic esthetician, or Minnesota cosmetology license.

ESTH 1710 Risk Management for Estheticians
(online) 2
ESTH 1712 Advanced Exfoliation 4
ESTH 1714 Advanced Skin Care Techniques 5
ESTH 1716 Advanced Clinic 1
for Estheticians 4
ESTH 1718 Advanced Clinic 2
for Estheticians 4
Total Semester Credits 19

Third Semester

Goal 1: ENGL 1711 Composition 4
Goal 3: CHEM 1711 Principles of Chemistry 4
Total Semester Credits 8

Fourth Semester

Goal 1: COMM 1720 Interpersonal
Communication 3
Goal 5: PSYC 1720 Psychology Throughout
the Lifespan 3
Goal 6: Humanities and Fine Arts 3
Total Semester Credits 9

OPTION TWO

First Semester

Goal 1: COMM 1720 Interpersonal
Communication 3
Goal 3: CHEM 1711 Principles of Chemistry 1 4
Goal 5: PSYC 1720 Psychology Throughout
the Lifespan 3
Goal 6: Humanities and Fine Arts 3
Total Semester Credits 13

Second Semester

Goal 1: ENGL 1711 Composition 1 4
CHSN 1598 Body Systems and Disease
(online) 4
This course is a prerequisite to or must be taken concurrently with CHSN 1599, ESTH 1645, ESTH 1650, ESTH 1651 and ESTH 1652.
May be taken the semester prior to
FIRST SEMESTER, including summer.

CHSN 1599 Preclinic Introduction (online) 4
This course is a prerequisite to or must be taken concurrently with CHSN 1598, ESTH 1645, ESTH 1650, ESTH 1651 and ESTH 1652.
May be taken the semester prior to
FIRST SEMESTER, including summer.

Total Semester Credits 12

Third Semester

ESTH 1645 Cosmetic Chemistry & Makeup
Applications 4
This course is a prerequisite to ESTH 1650
ESTH 1650 Skin Analysis & Massage 4
ESTH 1651 Clinic 1 for Estheticians 4
ESTH 1652 Clinic 2 for Estheticians 4
Total Semester Credits 16

Fourth Semester

All 17XX level classes run concurrently in the same semester. In order to register for Advanced level esthetics classes series ESTH 17XX, students must have verification of: completion of all training and passing results of all state written and practical skills testing for basic esthetics or cosmetology in accordance with Law and Rule of the Minnesota Board of Cosmetology; or current/active Minnesota basic esthetician or Minnesota cosmetology license.

ESTH 1710 Risk Management for Estheticians
(online) 2
ESTH 1712 Advanced Exfoliation 4
ESTH 1714 Advanced Skin Care Techniques 5
ESTH 1716 Advanced Clinic 1 for Estheticians 4
ESTH 1718 Advanced Clinic 2 for Estheticians 4
Total Semester Credits 19

Total Program Credits 60

Cosmetology Student Handbook/ Agreement Form

All new and returning students will need to access D2L Brightspace PRIOR to the first day of classes to read the Cosmetology student handbook. After you have read the handbook, you MUST print and sign Student Agreement Form, Hepatitis B Vaccination/Declination Form, Property and Equipment Form, and Rollabout Form and return them to your instructor on the FIRST DAY of class before you will be admitted to class. You will need to perform this task prior to the first day of each semester. Please direct questions to the assigned instructor of your first class.

Advanced Esthetics Classes Prerequisite

In order to register for Advanced level esthetics classes series ESTH 17XX, students must have verification of: completion of all training and passing results of all state written and practical skills testing for basic esthetics or cosmetology in accordance with Law and Rule of the Minnesota Board of Cosmetology; or current/active Minnesota basic esthetician or Minnesota cosmetology license.

All necessary documents must be submitted to the program faculty for verification prior to registration.

Transfer Opportunities

Saint Paul College has a transfer articulation agreement between the following program and post-secondary institutions for the baccalaureate degree programs listed below.

For more information please go to saintpaul.edu/Transfer.

Esthetician Advanced Practice AAS

- BA Health Care Administration
Concordia University, St. Paul
- BA Individualized Studies
Metropolitan State University
- BS Healthcare and Human Service
Management
Saint Mary's University,
Twin Cities Camp

Esthetician DIPLOMA

Program Overview

Esthetician services include specialized work with skin care products, analysis of skin, massage techniques and facials. Students learn to tint brows and lashes, apply makeup, provide temporary hair removal and to use machines designed to administer skin treatments.

The Esthetic diploma program prepares the student for the CIDESCO examination.

Career Opportunities

After esthetician students complete 600 hours of skills and theory training and pass the written exam through the State designated testing service and skills certification, they are eligible for licensure through the Minnesota Board of Cosmetologist Examiners. Estheticians work in a variety of settings including salons, spas, fitness centers, dermatologist, plastic surgeon offices and hospitals.

CIDESCO certification holders are able to license as an esthetician technician, certify as a massage therapist, and license as a nail technician upon completion of clinic nail hours. Cross trained therapists are able to work in Spas, Medical Offices, Cruise Ships and 5 Star Resorts.

Licensing or certification exams are independent of graduation requirements.

Program Outcomes

1. Graduates will be prepared to take the Esthetician Practical Skills test.
2. Graduates will be prepared to take the Minnesota State Esthetician written exam and state law test administered through the state designated testing services (access through www.bceboard.state.mn.us)
3. Graduates will have knowledge and skills in salon operations focusing on skin services.
4. Graduates will have knowledge in cosmetic care product ingredients
5. Graduates will have knowledge in skin care, massage Spa Techniques and Nail Care.
6. Graduates will be prepared for employment as Esthetician, Massage Therapist and Nail Technician.
7. Graduates will have knowledge and skills in Spa operations focusing on therapeutic skin services, massage and nail care.
8. Graduates will be prepared to take the CIDESCO exam.

Program Faculty

Lyubov Babina lyubov.babina@saintpaul.edu

Textbook and Supply Costs

Students should expect to spend approximately \$1,900.00 for esthetics books and supplies (first semester). Tuition, college fees and books for remaining courses are not included in this cost. Items can be purchased in the College Bookstore. In addition, there is a fee to take the Minnesota licensure exam.

Be prepared to purchase all Esthetics kits with the instructor on the second day of class. Financial aid must have been completed.

CIDESCO Certification Exam

Graduates of this diploma program are eligible to take the CIDESCO certification exam. The cost of this exam is approximately \$350.00 for under graduate students and approximately \$650.00 for post graduate students. After passing the CIDESCO exam a fee of \$65.00 is charged for the CIDESCO diploma and pin. ESTH 1670 CIDESCO Exam Student Preparation class and the CIDESCO exam is offered summer semester only.

The Esthetician Diploma will meet the criteria for the CIDESCO exam requirement of 1200 hours of training in skin, massage and nail services.

The CIDESCO examination includes:

- a facial examination
- a body examination
- a waxing examination
- a make-up examination
- a tinting examination
- a massage examination
- an additional subject, and
- a written examination.

*Information is subject to change.
This Program Requirements Guide is not a contract.*

CIDESCO

Saint Paul College – A Community and Technical College Esthetician Program is a CIDESCO school. This means the program is allowed to prepare candidates for the CIDESCO examination. CIDESCO is the World's Major International Beauty Therapy Association:

- Founded in 1946 with its Head Office in Zurich, Switzerland.
- CIDESCO is represented in over 37 countries.
- The CIDESCO Diploma is the world's most prestigious qualification in the field of Aesthetics and Beauty Therapy.
- Since 1957, the CIDESCO qualification has set standards that have been initiated over the five continents of the globe.

Program Start Dates

Fall, Spring
Summer – online CHSN 1598 & CHSN 1599 only

Course Sequence

The course sequence listed on the back of this guide is required.

Cosmetology Student Handbook/ Agreement Form

All new and returning students will need to access D2L Brightspace PRIOR to the first day of classes to read the Cosmetology student handbook. After you have read the handbook, you must print and sign Student Agreement Form, Hepatitis B Vaccination/Declination Form, Property and Equipment Form, and Rollabout Form and return them to your instructor on the first day of class before you will be admitted to class. You will need to perform this task prior to the first day of each semester. Please direct questions to the assigned instructor of your first class.

*See back of this guide for
Program Requirements & Course Sequence*

Minimum Program Entry Requirements

Students entering this program must meet the following minimum program entry requirements:

Reading: Score of 60+ or grade of "C" or better in READ 0721

Writing: Score of 60+ on Reading Comprehension or grade "C" or better in ENGL 0921

Arithmetic: Score of 52+ or grade of "C" or better in MATH 0745

Assessment Results and Prerequisites: Students admitted into Saint Paul College programs may need to complete additional courses based on assessment results and course prerequisite requirements. Certain MATH, READ, and ENGL courses have additional prerequisites.

222D (7172)



Comite International d' Esthetique et de Cosmetologie
e-mail: info@cidesco.com
website: www.cidesco.com

Esthetician DIPLOMA *(continued)*

Program Requirements

<input checked="" type="checkbox"/>	Check off when completed	
<input type="checkbox"/>	Required Program Orientation	
	All Cosmetology, Esthetics and Nail Technician applicants must attend a program orientation prior to enrollment as a full-time student. Please call the Clinic receptionist at 651.846.1329 to reserve your space at an orientation.	
Course		Cr
<input type="checkbox"/>	CHSN 1598 Body Systems & Diseases (online)	4
<input type="checkbox"/>	CHSN 1599 Preclinic Introduction (online)	4
<input type="checkbox"/>	COSM 1603 Preclinic Nail Care	3
<input type="checkbox"/>	COSM 1908 Clinic 1 for Nail Technicians	3
<input type="checkbox"/>	ESTH 1645 Cosmetic Chemistry & Makeup Applications	4
<input type="checkbox"/>	ESTH 1650 Skin Analysis and Massage	4
<input type="checkbox"/>	ESTH 1651 Clinic 1 for Estheticians	4
<input type="checkbox"/>	ESTH 1652 Clinic 2 for Estheticians	4
<input type="checkbox"/>	ESTH 1670 CIDESCO Exam Student Preparation	3
	<i>This course is offered only Summer Term</i>	
<input type="checkbox"/>	HLTH 1410 Medical Terminology	1
<input type="checkbox"/>	HLTH 1421 Anatomy & Physiology for the Somatic Practitioner	4
<input type="checkbox"/>	HLTH 1425 Clinical Applications in Kinesiology	3
<input type="checkbox"/>	MASS 1400 Introduction to Therapeutic Massage	4
<input type="checkbox"/>	MASS 1421 Massage Spa Techniques	2
<input type="checkbox"/>	MASS 1422 Massage Clinical Techniques	4
<input type="checkbox"/>	MASS 1480 Massage Therapy Practicum	4
	Subtotal	55
General Education/MnTC Requirements		Cr
	Refer to the Minnesota Transfer Curriculum Course List for each Goal Area	
<input type="checkbox"/>	Goal 1: Communication	3
	COMM 17XX (COMM 1720 Interpersonal Communication recommended) 3 cr	
<input type="checkbox"/>	Goal 3: Natural Sciences	3
	BIOL 1760 Nutrition 3 cr	
<input type="checkbox"/>	Goals 1-10 of the Minnesota Transfer Curriculum	3
	Select a minimum of 3 additional credits	
	General Education Requirements	9
	Total Program Credits	64

Course Sequence

The following course sequence is required.
Not all courses are offered each semester.

First Semester

CHSN 1598 Body Systems & Diseases (online)	4
<i>This course is a prerequisite to or must be taken concurrently with ESTH 1645, ESTH 1650, ESTH 1651 and ESTH 1652</i>	
CHSN 1599 Preclinic Introduction (online)	4
<i>This course is a prerequisite to or must be taken concurrently with ESTH 1645, ESTH 1650, ESTH 1651 and ESTH 1652</i>	
ESTH 1645 Cosmetic Chemistry & Makeup Applications	4
ESTH 1650 Skin Analysis and Massage	4
ESTH 1651 Clinic 1 for Estheticians	4
ESTH 1652 Clinic 2 for Estheticians	4
<i>This course is a prerequisite to ESTH 1650</i>	
Total Semester Credits	24

Second Semester

COSM 1603 Preclinic Nail Care	3
COSM 1908 Clinic 1 for Nail Technicians	3
HLTH 1410 Medical Terminology	1
HLTH 1421 Anatomy & Physiology for the Somatic Practitioner	4
MASS 1400 Introduction to Therapeutic Massage	4
Goal 1: COMM 17XX (COMM 1720 Interpersonal Communication recommended)	3
Goal 3: BIOL 1760 Nutrition	3
Total Semester Credits	21

Third Semester

ESTH 1670 CIDESCO Exam Student Prep	3
<i>This course is offered only Summer Term</i>	
HLTH 1425 Clinical Applications in Kinesiology	3
MASS 1421 Massage Spa Techniques	2
MASS 1422 Massage Clinical Techniques	4
MASS 1480 Massage Therapy Practicum	4
Goals 1-10: General Education Electives	3
Total Semester Credits	19

Total Program Credits **64**

Esthetician CERTIFICATE

Program Overview

Esthetician services include specialized work with skin care products, analysis of skin, skin exfoliation, massage techniques, and facials. Students learn to tint brows and lashes, apply makeup, provide temporary hair removal, and use machines designed to administer skin treatments.

Career Opportunities

After esthetician students complete 600 hours of skills and theory training and pass the written exam through the State designated testing service and skills certification, they are eligible for licensure through the Minnesota Board of Cosmetologist Examiners. Estheticians work in a variety of settings including salons, spas, fitness centers, as well as dermatology and plastic surgeon's offices and hospitals.

Licensing or certification exams are independent of graduation requirements.

Program Outcomes

1. Graduates will be prepared to take the Esthetician Practical Skills Test.
2. Graduates will be prepared to take the Minnesota State Esthetician written exam and state law test administered through the state designated testing service (access through www.bceboard.state.mn.us)
3. Graduates will have knowledge and skills in esthetician (skin) services.
4. Graduates will have knowledge in cosmetic care product ingredients.
5. Graduates will be prepared for employment as an esthetician.

Minimum Program Entry Requirements

Students entering this program must meet the following minimum program entry requirements:

Reading: Score of 60+ or grade of "C" or better in READ 0721

Writing: Score of 60+ on Reading Comprehension or grade of "C" or better in ENGL 0921

Arithmetic: Score of 31+

Assessment Results and Prerequisites:

Students admitted into Saint Paul College programs may need to complete additional courses based on assessment results and course prerequisite requirements. Certain MATH, READ, and ENGL courses have additional prerequisites.

056C (7042)

Program Faculty

Lyubov Babina lyubov.babina@saintpaul.edu

Program Length

Full-time students can complete the program in one semester provided the 3-credit General Education requirement has also been met.

Full-time Options

Full-time students can complete the program in one semester by attending 32 hours per week (Tuesday – Friday, 8:00am–4:30pm).

Textbook and Supply Costs

Students should expect to spend approximately \$1,900.00 for books and supplies. This cost is beyond the cost of tuition and fees. In addition, there is a fee to take the Minnesota licensure exam.

Items can be purchased in the College Bookstore. Be prepared to purchase all esthetics kits with the instructor on the second day of class. Financial aid must have been completed.

Program Requirements

- Check off when completed
- Required Program Orientation**
All Cosmetology, Esthetics and Nail Technician applicants must attend a program orientation prior to enrollment as a full-time student. Please call the Clinic receptionist at 651.846.1329 to reserve your space at an orientation.

Course	Cr
<input type="checkbox"/> CHSN 1598 Body Systems & Diseases (online)	4
<input type="checkbox"/> CHSN 1599 Preclinic Introduction (online)	4
<input type="checkbox"/> ESTH 1645 Cosmetic Chemistry & Makeup Applications	4
<input type="checkbox"/> ESTH 1650 Skin Analysis & Massage	4
<input type="checkbox"/> ESTH 1651 Clinic 1 for Estheticians	4
<input type="checkbox"/> ESTH 1652 Clinic 2 for Estheticians	4
Subtotal	24

General Education/MnTC Requirements Cr

Refer to the Minnesota Transfer Curriculum Course List for each Goal Area (General education requirements must be completed and passed before paperwork for licensure will be released).

- Goals 1-10 of the Minnesota Transfer Curriculum. 3
(COMM 1720 Interpersonal Communication - recommended)
- General Education Requirements** 3

Total Program Credits 27

*Information is subject to change.
This Program Requirements Guide is not a contract.*

Program Start Dates

Fall, Spring,
Summer – online CHSN 1598 & CHSN 1599 only

Course Sequence

The following sequence is required. Not all courses are offered during summer session.

1 Semester – Day Full-time

CHSN 1598 Body Systems & Diseases (online)	4
<i>This course is a prerequisite to or must be taken concurrently with ESTH 1645, ESTH 1650, ESTH 1651 and ESTH 1652</i>	
CHSN 1599 Preclinic Introduction (online)	4
<i>This course is a prerequisite to or must be taken concurrently with ESTH 1645, ESTH 1650, ESTH 1651 and ESTH 1652</i>	
ESTH 1645 Cosmetic Chemistry and Makeup Applications	4
<i>This course is a prerequisite to ESTH 1650</i>	
ESTH 1650 Skin Analysis and Massage	4
ESTH 1651 Clinic 1 for Estheticians	4
ESTH 1652 Clinic 2 for Estheticians	4
General Education Requirements	3
<i>(General education requirements must be completed and passed before paperwork for licensure will be released)</i>	
Total Semester Credits	27

Total Program Credits 27

Cosmetology Student Handbook/ Agreement Form

All new and returning students will need to access D2L Brightspace PRIOR to the first day of classes to read the Cosmetology student handbook. After you have read the handbook, you must print and sign Student Agreement Form, Hepatitis B Vaccination/Declination Form, Property and Equipment Form, and Rollabout Form and return them to your instructor on the first day of class before you will be admitted to class. You will need to perform this task prior to the first day of each semester. Please direct questions to the assigned instructor of your first class.

CIDESCO

Saint Paul College – A Community and Technical College Esthetician Program is a CIDESCO school. This means the program is allowed to prepare candidates for the CIDESCO examination.



Comite International d'Esthetique
et de Cosmetologie
e-mail: info@cidesco.com
website: www.cidesco.com

Esthetics Advanced Practice CERTIFICATE

Program Overview

Advanced Practice (AP) esthetics services include specialized training and clinical practice in four AP esthetics categories: chemical exfoliation of the skin, waxfoliation of the skin using a machine or device, advanced skin care techniques, and skin needling.

The Advanced Practice Esthetics Certificate is designed to be the next level of training for the esthetician or cosmetologist that wishes to specialize in the aforementioned categories including advanced understanding of skin anatomy and physiology, skin histology, skin care products and ingredients, pre and post treatment regimens, client consultation including skin analysis and skin typing, and risk management. Students learn to perform chemical peels, microdermabrasion, dermaplaning, skin needling, and facials utilizing machines, electrical devices and lymphatic drainage.

This certificate is for the student who has a current/active Minnesota basic esthetician license, Minnesota cosmetology license; or for the student who has completed all theory, practical training and state testing as defined in Rule by the State of Minnesota and the Minnesota Board of Cosmetology and is progressing onto the next level of esthetics licensure.

Career Opportunities

After AP Esthetics students complete all theory, practical training and state testing as defined in Rule by the State of Minnesota and the Minnesota Board of Cosmetology, they are eligible for licensure through the Minnesota Board of Cosmetology. AP estheticians work in a variety of settings including salons, spas, fitness centers, medi-spa's, and skin clinics. AP estheticians may also have their own Advanced Practice Esthetics business.

Program Outcomes

1. Graduates will be prepared to take the AP esthetician practice skills test.
2. Graduates will be prepared to take the Minnesota State AP esthetics written practical, theory, and state law test administered through the state designated testing service (access information at <https://mn.gov/boards/cosmetology/>).
3. Graduates will have advanced knowledge and skills in AP esthetician services.
4. Graduates will possess advanced knowledge in skin care products and ingredients.
5. Graduates will have advanced knowledge of Pharmaceutical Grade Chemical Peels.
6. Graduates will have advanced knowledge and skills in licensed salon operations focusing on AP esthetics services.
7. Graduates will have the advanced knowledge and skills for work and life roles.
8. Graduates will be prepared for employment as an AP esthetician.

Program Faculty

Julie Evans julie.evans@saintpaul.edu

Textbook and Supply Costs

Students should expect to spend approximately \$2,00.00 for Advanced Practice esthetics books and supplies. Tuition, college fees and books for remaining courses are not included in this cost. Items can be purchased in the College Bookstore. Be prepared to purchase all esthetics kits with the instructor on the second day of class.

Financial aid must have been completed. In addition, there are required fees to take the Minnesota licensing exams and obtain a Minnesota license.

Cosmetology Student Handbook/ Agreement Form

All new and returning students will need to access D2L Brightspace PRIOR to the first day of classes to read the Cosmetology Student Handbook. After you have read the handbook, you MUST print and sign the Student Agreement Form, Hepatitis B Vaccination/Declination Form, Property and Equipment Form, and Rollabout form and return them to your instructor the FIRST DAY of class before you will be admitted to class. You will need to perform this task prior to the first day of EACH semester. Please direct questions to the assigned instructor of your first class.

Program Requirements

- Check off when completed
- Required Program Orientation**
All Cosmetology, Esthetics, Advanced Practice Esthetics and Nail Technician applicants must attend a program orientation prior to enrollment as a full-time student. Please call the Clinic Receptionist at 651.846.1329 to reserve your space at orientation.

Course	Cr/HR
<input type="checkbox"/> ESTH 1710 Risk Management for Estheticians (online)	2/40
<input type="checkbox"/> ESTH 1712 Advanced Exfoliation.	4/112
<input type="checkbox"/> ESTH 1714 Advanced Skin Care Techniques	5/128
<input type="checkbox"/> ESTH 1716 Advanced Clinic 1 for Estheticians	4/128
<input type="checkbox"/> ESTH 1718 Advanced Clinic 2 for Estheticians	4/128
Subtotal.	19/536
Total Program Credits	19

*Information is subject to change.
This Program Requirements Guide is not a contract.*

Program Start Dates

Fall, Spring

Course Sequence

The following course sequence is required and can be completed by full-time students in one semester.

First Semester

ESTH 1710 Risk Management for Estheticians (online)	2
ESTH 1712 Advanced Exfoliation	4
ESTH 1714 Advanced Skin Care Techniques	5
ESTH 1716 Advanced Clinic 1 for Estheticians	4
ESTH 1718 Advanced Clinic 2 for Estheticians	4
Total Semester Credits.	19

Total Program Credits 19

Current Minnesota Esthetics or Cosmetology License:

Students must bring a copy of their license on the first day of class. A copy will be added to the students' permanent file.

Advanced Esthetics Classes Prerequisite

In order to register for Advanced level esthetics classes series ESTH 17XX, students must have verification of: completion of all training and passing results of all state written and practical skills testing for basic esthetics or cosmetology in accordance with Law and Rule of the Minnesota Board of Cosmetology; or current/active Minnesota basic estheticians or Minnesota cosmetology license.

All necessary documents must be submitted to the program faculty for verification prior to registration.

Minimum Program Entry Requirements

Students entering this program must meet the following minimum program entry requirements:

Reading: Score of 60+ or grade of "C" or better in READ 0721

Writing: Score of 60+ or grade of "C" or better in ENGL 0921

Arithmetic: Score of 52+ or grade of "C" or better in MATH 0745

Assessment Results and Prerequisites: Students admitted to Saint Paul College programs may need to complete additional courses based on assessment results and course prerequisite requirements. Certain MATH, READ, and ENGL courses have additional prerequisites.

Esthetics for Cosmetologist CERTIFICATE

Program Overview

This certificate will provide advanced education for the licensed cosmetologist who would like to expand their knowledge of skin care services. The certificate can be completed within one semester. **Program enrollment requires current Minnesota Esthetics or Cosmetology license.**

Career Opportunities

The licensed cosmetologist would now be able to seek employment in a setting specializing in skin care. Employment opportunities include: salons, spas and fitness centers.

Program Outcomes

1. Graduates will have accrued an additional 320 hours of education focused on skin care.
2. Graduates will have demonstrated knowledge of skin care services.
3. Graduates will have demonstrated practical application of skin care services.
4. Graduates will have knowledge of cosmetic product ingredients.
5. Graduates will be prepared for employment offering skin care services.

Program Faculty

Lyubov Babina lyubov.babina@saintpaul.edu

Textbook and Supply Costs

Students should expect to spend approximately \$1850.00 for books and supplies. This cost is beyond the cost of tuition and fees. Items can be purchased in the College Bookstore.

Program Requirements

Check off when completed

Required Program Orientation

All Cosmetology, Esthetics and Nail Technician applicants must attend a program orientation prior to enrollment as a full-time student. Please call the Clinic receptionist at 651.846.1329 to reserve your space at an orientation.

Course	Cr
<input type="checkbox"/> ESTH 1645 Cosmetic Chemistry & Makeup Applications	4
<input type="checkbox"/> ESTH 1650 Skin Analysis & Massage	4
<input type="checkbox"/> ESTH 1651 Clinic 1 for Estheticians	4

Total Program Credits12

Program Start Dates

Fall, Spring

Course Sequence

The following sequence is recommended.

Full-time students can complete the program in one semester.

First Semester

ESTH 1645 Cosmetic Chemistry & Makeup Applications	4
ESTH 1650 Skin Analysis & Massage	4
ESTH 1651 Clinic 1 for Estheticians	4

Total Program Credits12

Current Minnesota Esthetics or Cosmetology License:

Students must bring a copy of their license on the first day of class. A copy will be added to the students' permanent file.

Minimum Program Entry Requirements

Students entering this program must meet the following minimum program entry requirements:

Reading: Score of 60+ or grade of "C" or better in READ 0721

Writing: Score of 60+ or grade of "C" or better in ENGL 0921

Arithmetic: Score of 31+

Assessment Results and Prerequisites:

Students admitted to Saint Paul College programs may need to complete additional courses based on assessment results and course prerequisite requirements. Certain MATH, READ, and ENGL courses have additional prerequisites.

365C

*Information is subject to change.
This Program Requirements Guide is not a contract.*

CIDESCO Readiness CERTIFICATE

Program Overview

This certificate is designed for the licensed esthetician or licensed cosmetologist who wants to examine for the International CIDESCO certification. It provides the course work to support the CIDESCO exam prep class and CIDESCO examination. With CIDESCO certification, the licensed esthetician is able to complete a massage program, certify as a massage therapist, complete a nail technician program and obtain a nail technician license. CIDESCO is the world's largest major International Beauty Association. **Program enrollment requires a current Minnesota Cosmetology or Esthetics license.**

Career Opportunities

The CIDESCO certification holder is cross trained and able to offer potential employers, skills in esthetics, massage therapy, body assessment and treatment and nail care. Cross trained therapists are able to work in spas, medical offices, fitness centers, 5 star resort spas, and on cruise ships.

Program Outcomes

1. Graduates will have knowledge and skills in esthetician services.
2. Graduates will have knowledge and skills needed for body assessment and body treatments.
3. Graduates will have knowledge and skills to assist clients with diet and exercise.
4. Graduates will have knowledge in cosmetic product ingredients.
5. Graduates will have knowledge and skills for work and life roles.
6. Graduates will have determined a topic for the CIDESCO special project.
7. Graduates will have prepared their CIDESCO special project for presentation during the exam.
8. Graduates will be prepared to take the International CIDESCO practical and written exam.

Program Faculty

Lyubov Babina lyubov.babina@saintpaul.edu

Program Requirements

Check off when completed

- Required Program Orientation**
All Cosmetology, Esthetics and Nail Technician applicants must attend a program orientation prior to enrollment as a full-time student. Please call the Clinic receptionist at 651.846.1329 to reserve your space at an orientation.

Course	Cr
<input type="checkbox"/> COSM 1603 Preclinic Nail Care	3
<input type="checkbox"/> ESTH 1645 Cosmetic Chemistry & Makeup Applications	4
<input type="checkbox"/> ESTH 1650 Skin Analysis & Massage	4
<input type="checkbox"/> ESTH 1651 Clinic 1 for Estheticians	4
<input type="checkbox"/> ESTH 1670 CIDESCO Exam Student Prep	3
<i>Class offered only summer term</i>	
<input type="checkbox"/> HLTH 1410 Medical Terminology	1
<input type="checkbox"/> HLTH 1421 Anatomy & Physiology for the Somatic Practitioner	4
<input type="checkbox"/> MASS 1400 Introduction to Therapeutic Massage	4
Subtotal	27

General Education/MnTC Requirements	Cr
Refer to the Minnesota Transfer Curriculum Course List for each Goal Area	
<input type="checkbox"/> Goal 3: Natural Sciences	3
BIOL 1760 Nutrition – 3 cr	
General Education Requirements	3
Total Program Credits	30

Textbook and Supply Costs

Students should expect to spend approximately \$1900.00 for esthetics books and supplies (ESTH 1645, 1650 & 1651). Tuition, college fees, and books required for remaining courses are not included in this cost. Items can be purchased in the College Bookstore. Financial aid must have been completed.

*Information is subject to change.
This Program Requirements Guide is not a contract.*

Program Start Dates

Fall, Spring

Course Sequence

The following sequence is recommended. Not all courses are offered during summer session.

Full-time students can complete the program in two semesters.

First Semester

ESTH 1645 Cosmetic Chemistry & Makeup Applications	4
ESTH 1650 Skin Analysis & Massage	4
ESTH 1651 Clinic 1 for Estheticians	4
Goal 3: BIOL 1760 Nutrition	3
Total Semester Credits	15

Second Semester

COSM 1603 Preclinic Nail Care	3
ESTH 1670 CIDESCO Exam Student Prep*	3
HLTH 1410 Medical Terminology	1
HLTH 1421 Anatomy & Physiology for the Somatic Practitioner	4
MASS 1400 Introduction to Therapeutic Massage	4
Total Semester Credits	15

Total Program Credits **30**

*This course is only offered summer term.

Current Minnesota Esthetics or Cosmetology License:

Students must bring a copy of their license on the first day of class. A copy will be added to the students' permanent file.

Minimum Program Entry Requirements

Students entering this program must meet the following minimum program entry requirements:

Reading: Score of 60+ or grade of "C" or better in READ 0721

Writing: Score of 60+ or grade of "C" or better in ENGL 0921

Arithmetic: Score of 31+

Assessment Results and Prerequisites: Students admitted to Saint Paul College programs may need to complete additional courses based on assessment results and course prerequisite requirements. Certain MATH, READ, and ENGL courses have additional prerequisites.

This advanced certificate is designed for the licensed esthetician or licensed cosmetologist.

343C

CIDESCO

Saint Paul College – A Community and Technical College Esthetician Program is a CIDESCO school. This means the program is allowed to prepare candidates for the CIDESCO examination.



Comite International d'Esthetique et de Cosmetologie
e-mail: info@cidesco.com
website: www.cidesco.com

Health Information Technology AAS DEGREE

Program Overview

Health Information Technicians play a vital role in the health care industry by participating in the creation, completion, distribution and retention of medical record documentation according to policies and procedures outlined by several regulating bodies such as the Joint Commission on Accreditation of Healthcare Organization (JCAHO) and Medicare.

Individuals enrolled in the program will obtain a broad body of knowledge that will allow them to become employed in many capacities within a health information department. Some of the positions include such tasks as: release of information, various registries, incomplete chart room, processing of medical documentation, coding and abstracting, and may include supervisory or leadership roles based on skill and ability. Students who successfully complete the Health Information Technology degree are allowed to sit for the national examination given by the American Health Information Management Association to become a Registered Health Information Technician upon successful completion of the examination.

Career Opportunities

Graduates of the Health Information Technology degree will find positions in various health care settings such as private physician offices, clinics, specialty clinics, hospitals, long-term care facilities, and rehabilitation facilities. Employment can also be found in government offices, the insurance industry, dental and chiropractic clinics, and information technology suppliers.

Program Outcomes

1. Graduates will apply policies and procedures to assure the accuracy of health information.
2. Graduates will use specialized software in the completion of HIM processes such as record tracking, release of information, coding, grouping, registries, billing, and quality improvement.
3. Graduates will apply procedure codes using ICD-10 PCS & CM and CPT/HCPCS.
4. Graduates will apply policies and procedures to comply with the changing regulations among various payment systems for healthcare services.
5. Graduates will possess a knowledge base which will allow them to find employment in the health care industry.
6. Graduates of a Commission on Accreditation of Health Informatics and Information Management accredited Health Information Technology program are eligible to apply to write the American Health Information Management Association, Registered Health Information Technician (RHIT) certificate examination.

Program Faculty

Jennifer Anglin jennifer.anglin@saintpaul.edu
 Kelly Dale kelly.dale@saintpaul.edu

Part-time/Full-time Options

This program can be completed by using a combination of online, day, evening, and Saturday courses. Part-time and full-time options are available.

Program Requirements

- Check off when completed
- All classes must be successfully completed with grade "C" or better.

Course	Cr
<input type="checkbox"/> BTEC 1421 Business Information Applications 1 . . . 3	
<input type="checkbox"/> BUSN 1480 Business Career Resources 1	
<input type="checkbox"/> MEDS 1420 Health Information Foundations. 3	
<input type="checkbox"/> MEDS 1470 Anatomy & Physiology/Medical Office. . 3	
<input type="checkbox"/> MEDS 1480 Medical Terminology 3	
<input type="checkbox"/> MEDS 1560 Computerized Health Information . . . 3	
<input type="checkbox"/> MEDS 1562 Billing and Reimbursement 2	
<input type="checkbox"/> MEDS 1570 Human Disease. 3	
<input type="checkbox"/> MEDS 2430 Pharmacology for the Medical Office. . 2	
<input type="checkbox"/> MEDS 2432 Alternative Health Record Systems . . 2	
<input type="checkbox"/> MEDS 2434 Legal and Ethical Aspects of Health Information 2	
<input type="checkbox"/> MEDS 2440 Supervision of Health Information . . . 2	
<input type="checkbox"/> MEDS 2461 ICD-10-CM Coding. 3	
<input type="checkbox"/> MEDS 2462 ICD-10-PCS Coding 4	
<input type="checkbox"/> MEDS 2470 CPT-4 Coding 3	
<input type="checkbox"/> MEDS 2480 Advanced Coding. 3	
<input type="checkbox"/> MEDS 2510 Quality Management and Health Statistics 3	
<input type="checkbox"/> MEDS 2590 HIT Internship/Capstone Project . . . 3	
Subtotal. 48	

General Education/MnTC Requirements	Cr
Refer to the Minnesota Transfer Curriculum Course List for each Goal Area	
<input type="checkbox"/> Goal 1: Communication 7	
ENGL 1711 Composition 1 – 4 cr	
COMM 17XX – 3 cr	
<input type="checkbox"/> Goal 3 or Goal 4 3	
Goal 3: Natural Sciences OR	
Goal 4: Mathematical/Logical Reasoning	
<input type="checkbox"/> Goal 5: History, Social Science and Behavioral Sciences 3	
<input type="checkbox"/> Goal 6: Humanities and Fine Arts. 3	
General Education Requirements 16	

Total Program Credits 64

*Information is subject to change.
 This Program Requirements Guide is not a contract.*

Program Start Dates

Fall

Course Sequence

The course sequence listed on the back of this guide is recommended for a full-time student; however, this sequence is not required. Contact Program Faculty with questions.

See back of this guide for Course Sequence, Admissions Info & Transfer Opportunities



The Health Information Technology AAS Degree Program is accredited by the Commission on Accreditation for Health Informatics and Information Management Education (www.cahiim.org).

Minimum Program Entry Requirements

Students entering this program must meet the following minimum program entry requirements:

Reading: Score of 78+ or grade of "C" or better in READ 0722

Writing: Score of 78+ on Reading Comprehension or grade of "C" or better in ENGL 0922

Arithmetic: Score of 52+ or grade of "C" or better in MATH 0745

Keyboarding Skills: Minimum of 40 WPM with 3 errors or less or a grade of "C" or better in BTEC 1400.

Computer Skills: Basic computer skills such as word processing, spreadsheets, and Internet usage or a grade of "C" or better in BTEC 1418.

Assessment Results and Prerequisites: Students admitted into Saint Paul College programs may need to complete additional courses based on assessment results and course prerequisite requirements. Certain MATH, READ, and ENGL courses have additional prerequisites.

264A 625A (7142)

Health Information Technology AAS DEGREE *(continued)*

Course Sequence for Full-Time Schedule

The following course sequence is recommended for full-time students. Students must consult with a program advisor to develop an educational program plan before registration.

All classes must be successfully completed with grade of "C" or better.

First Semester (Year 1)

MEDS 1420 Health Information Foundations	3
MEDS 1470 Anatomy & Physiology/Medical Office	3
MEDS 1480 Medical Terminology	3
Goal 1: ENGL 1711 Composition 1	3
Goal 1: COMM 17XX	4
Total Semester Credits	16

Second Semester (Year 1)

MEDS 1570 Human Disease	3
MEDS 2430 Pharmacology for the Medical Office	2
MEDS 2461 ICD-10-CM Coding (spring only)	3
MEDS 2462 ICD-10-PCS Coding (spring only)	4
MEDS 2470 CPT-4 Coding (spring only)	3
Total Semester Credits	15

Third Semester (Year 2)

BTEC 1421 Bus Info Apps 1	3
MEDS 1560 Computerized Health Information	3
MEDS 2432 Alternative Health Record Systems (fall only)	2
MEDS 2434 Legal Aspects of Health Information (fall only)	2
MEDS 2480 Advanced Coding (fall only)	3
Goal 3: Natural Sciences OR Goal 4: Mathematical/Logical Reasoning	3
Total Semester Credits	16

Fourth Semester (Year 2)

BUSN 1480 Business Career Resources	1
MEDS 1562 Billing and Reimbursement (spring only)	2
MEDS 2440 Supervision of Health Information (spring only)	2
MEDS 2510 Quality Management and Health Statistics (spring only)	3
MEDS 2590 HIT Internship/Capstone Project	3
Goal 5: History, Social Sciences, and Behavioral Sciences	3
Goal 6: Humanities and Fine Arts	3
Total Semester Credits	17

Total Program Credits64

Course Sequence for Part-Time Schedule

The following course sequence is recommended for part-time students. Students must consult with a program advisor to develop an educational program plan before registration.

*All classes must be successfully completed with a grade of "C" or better.

First Semester (Year 1)

BTEC 1421 Bus Info Apps 1	3
MEDS1470 Anatomy & Physiology/Medical Office	3
MEDS 1480 Medical Terminology	3
Total Semester Credits	9

Second Semester (Year 1)

MEDS 1420 Health Information Foundations	3
MEDS 1570 Human Disease	3
Goal 1: ENGL 1711 Composition 1	4
Total Semester Credits	10

Third Semester (Year 2)

MEDS 1560 Computerized Health Information	3
Goal 1: COMM: 17XX	3
Goal 3: Natural Sciences OR Goal 4: Mathematical/Logical Reasoning	3
MEDS 2430 Pharmacology for the Medical Office	2
Total Semester Credits	11

Fourth Semester (Year 2)

MEDS 1562 Billing and Reimbursement (spring only)	2
MEDS 2461 ICD-10-CM Coding (spring only)	3
MEDS 2462 ICD-10-PCS Coding (spring only)	4
MEDS 2470 CPT-4 Coding (spring only)	3
Total Semester Credits	12

Fifth Semester (Year 3)

BUSN 1480 Business Career Resources	1
Goal 5: History, Social Sciences, and Behavioral Sciences	3
MEDS 2432 Alternative Health Record Systems (fall only)	2
MEDS 2434 Legal Aspects of Health Information (fall only)	2
MEDS 2480 Advanced Coding (fall only)	3
Total Semester Credits	11

Sixth Semester (Year 3)

MEDS 2440 Supervision of Health Information (spring only)	2
MEDS 2510 Quality Management and Health Statistics (spring only)	3
MEDS 2590 HIT Internship/Capstone Project	3
Goal 6: Humanities and Fine Arts	3
Total Semester Credits	11

Total Program Credits64

Admission into the Program

Being admitted to Saint Paul College does not imply admission into the Health Information Technology Program.

All Health Information Technology students are required to complete an online orientation seminar to complete documentation prior to beginning any courses within the program of study.

Students admitted into the Health Information Technology Program are required to work with a faculty program advisor to arrange an educational program plan leading to graduation from the program.

Health Information Technology students are encouraged to communicate with their faculty program advisor prior to the start of each semester regarding their educational program plan. *Failure to communicate with a faculty program advisor may lead to increased time to complete the degree.

Transfer Opportunities

Saint Paul College has a transfer articulation agreement between the following program and post-secondary institutions for the baccalaureate degree programs listed below.

For more information please go to saintpaul.edu/Transfer.

Health Information Technology AAS

BA	Health Care Administration Concordia University, St. Paul
BA	Individualized Studies Metropolitan State University
BS	Healthcare and Human Service Management Saint Mary's University, Twin Cities Campus
BS	Health Information Management College of St. Scholastica
BS	Health Information Management Herzing University

Healthcare Informatics AAS DEGREE

Program Overview

The Healthcare Informatics program integrates education from health information, computer science and information technology.

Healthcare informatists work and support healthcare organizations in a multifaceted methodology by providing support directly related to industry practices and procedures regarding complex electronic health record systems.

Responsibilities may include supporting tasks and roles relating to data analysis, database design and administration, support of numerous software applications, implementation of data standards, knowledge of interoperability, and maintenance of clinical decision support protocols supported by evidence based medicine, routine system upgrades and preservation, system architecture, hardware, system networking, and legal knowledge to support information privacy and security.

Career Opportunities

Individuals enrolled in the program will obtain a broad body of knowledge of health information, computer science, and information technology that will allow them to become employed in many capacities within a healthcare system. Employment opportunities may include: data and information technology support personnel, analytics staff, data standards personnel, documentation integrity specialists, health information privacy and security personnel, electronic health record trainer or educator, implementation and data systems upgrade specialist and may include supervisory or leadership roles based on skill and ability.

Graduates of the Healthcare Informatics degree will find positions in various health care settings such as private physician offices, clinics, specialty clinics, hospitals, long-term care facilities, and rehabilitation facilities. Employment can also be found in government offices, the insurance industry, dental and chiropractic clinics, and information technology suppliers/vendors.

According to the Bureau of Labor Statistics, Computer User Support Specialists Occupations are anticipated to increase by +/- 12.8% between 2014-2024 (www.bls.gov).

Program Outcomes

1. Graduates will apply policies and procedures to assure the accuracy and integrity of information management based systems directly related to healthcare.
2. Graduates will use specialized software in the completion of health informatics and information management processes that include, working with practice management systems, data abstraction and analytics, record tracking, release of information, registries, and quality improvement initiatives.
3. Graduates will apply knowledge and skill set to manage and maintain healthcare related information systems.
4. Graduates will apply policies and procedures to comply with the changing regulations among various information systems within healthcare.
5. Graduates will possess a knowledge base, which will allow them to find employment in the healthcare industry.

Program Faculty

Jennifer Anglin jennifer.anglin@saintpaul.edu

Program Requirements

- Check off when completed
- All classes must be successfully completed with grade "C" or better.

Course	Cr
<input type="checkbox"/> CSCI 1410 Computer Science and Information Systems	4
<input type="checkbox"/> CSCI 1440 Networking Fundamentals	4
<input type="checkbox"/> CSCI 1523 Introduction to Computing and Programming Concepts	4
<input type="checkbox"/> CSCI 1550 Database Management Fundamentals	4
<input type="checkbox"/> CSCI 2410 Management Information Systems.	3
<input type="checkbox"/> CSCI 2570 Machine Architecture and Organization	4
<input type="checkbox"/> MEDS 1420 Health Information Foundations.	3
<input type="checkbox"/> MEDS 1470 Anatomy & Physiology/ Medical Office	3
<input type="checkbox"/> MEDS 1480 Medical Terminology	3
<input type="checkbox"/> MEDS 1560 Computerized Health Information	3
<input type="checkbox"/> MEDS 2432 Alternative Health Record Systems	2
<input type="checkbox"/> MEDS 2434 Legal and Ethical Aspects of Health Information	2
<input type="checkbox"/> MEDS 2440 Supervision of Health Information	2
<input type="checkbox"/> MEDS 2510 Quality Management and Health Statistics	3
Subtotal.	44

*Information is subject to change.
This Program Requirements Guide is not a contract.*

General Education/MnTC Requirements Cr

- Refer to the Minnesota Transfer Curriculum Course List for each Goal Area
- Goal 1: Communication7
ENGL 1711 Composition 1 – 4 cr
COMM 17XX – 3 cr
 - Goal 4: Mathematical/Logical Reasoning.3
MATH 1730 College Algebra (or higher) – 3 cr
 - Goal 5: History, Social Science and Behavioral Sciences3
 - Goal 6: Humanities and Fine Arts.3
- General Education Requirements 16**

Total Program Credits 60

Program Start Dates

Fall, Spring, Summer-limited course offerings

Course Sequence

The course sequence listed on the back of this guide is recommended for a full-time student; however, this sequence is not required. Contact Program Faculty with questions.

See back of this guide for Course Sequence and Transfer Opportunities

Minimum Program Entry Requirements

Students entering this program must meet the following minimum program entry requirements:

Reading: Score of 78+ or grade of "C" or better in READ 0722

Writing: Score of 78+ or grade of "C" or better in ENGL 0922

College Level Mathematics: Score of 50+ or grade of "C" or better in MATH 0920

Keyboarding Skills: Minimum of 40 WPM with 3 errors or less or a grade of "C" or better in BTEC 1400.

Computer Skills: Basic computer skills such as word processing, spreadsheets, and Internet usage or a grade of "C" or better in BTEC 1418.

Assessment Results and Prerequisites: Students admitted into Saint Paul College programs may need to complete additional courses based on assessment results and course prerequisite requirements. Certain MATH, READ, and ENGL courses have additional prerequisites.

337A (7193)

Healthcare Informatics AAS DEGREE *(continued)*

Course Sequence for Full-Time Schedule

The following sequence is recommended for full-time students. Students should consult with the program advisor to develop an appropriate educational plan.

All classes must be successfully completed with a grade of "C" or better.

First Semester (Year 1)

CSCI 1410 Computer Science and Information Systems	4
MEDS 1420 Health Information Foundations	3
MEDS 1470 Anatomy and Physiology of the Medical Office	3
MEDS 1480 Medical Terminology	3
Goal 1: COMM 17XX	3
Total Semester Credits	16

Second Semester (Year 1)

CSCI 1523 Introduction to Computing and Programming Concepts	4
CSCI 1550 Database Management Fundamentals	4
MEDS 1560 Computerized Health Information	3
Goal 1: ENGL 1711 Composition 1	4
Total Semester Credits	15

Third Semester (Year 2)

CSCI 2410 Management Information Systems	3
CSCI 2570 Machine Architecture and Organization	4
MEDS 2432 Alternative Health Record Systems	2
MEDS 2434 Legal and Ethical Aspects of Health Information	2
Goal 4: MATH 1730 College Algebra or higher	3
Total Semester Credits	14

Fourth Semester (Year 2)

CSCI 1440 Networking Fundamentals	4
MEDS 2440 Supervision of Health Information	2
MEDS 2510 Quality Management and Health Statistics	3
Goal 5: History, Social Sciences, and Behavioral Sciences	3
Goal 6: Humanities and Fine Arts	3
Total Semester Credits	15

Total Program Credits 60

Course Sequence for Part-Time Schedule

The following sequence is recommended for part-time students. Students should consult with the program advisor to develop an appropriate educational plan.

All classes must be successfully completed with a grade of "C" or better.

First Semester (Year 1)

CSCI 1410 Computer Science and Information Systems	4
MEDS 1470 Anatomy and Physiology of the Medical Office	3
MEDS 1480 Medical Terminology	3
Total Semester Credits	10

Second Semester (Year 1)

CSCI 1523 Introduction to Computing and Programming Concepts	4
MEDS 1420 Health Information Foundations	3
Goal 1: COMM 17XX	3
Total Semester Credits	10

Third Semester (Year 2)

MEDS 1560 Computerized Health Information	3
MEDS 2432 Alternative Health Record Systems	2
Goal 1: ENGL 1711 Composition 1	4
Total Semester Credits	9

Fourth Semester (Year 2)

CSCI 1550 Database Management Fundamentals	4
MEDS 2440 Supervision of Health Information	2
Goal 4: MATH 1730 College Algebra or higher	3
Total Semester Credits	9

Fifth Semester (Year 3)

CSCI 2410 Management Information Systems	3
CSCI 2570 Machine Architecture and Organization	4
MEDS 2434 Legal and Ethical Aspects of Health Information	2
Goal 5: History, Social Sciences, and Behavioral Sciences	3
Total Semester Credits	12

Sixth Semester (Year 3)

CSCI 1440 Networking Fundamentals	4
MEDS 2510 Quality Management and Health Statistics	3
Goal 6: Humanities and Fine Arts	3
Total Semester Credits	10

Total Program Credits 60

Transfer Opportunities

Saint Paul College has a transfer articulation agreement between the following program and post-secondary institutions for the baccalaureate degree programs listed below.

For more information please go to saintpaul.edu/Transfer.

Healthcare Informatics AAS

BA	Health Care Administration Concordia University, St. Paul
BA	Individualized Studies Metropolitan State University
BS	Healthcare and Human Service Management Saint Mary's University, Twin Cities Campus

Medical Office Professional AAS DEGREE

Program Overview

Medical Office Professionals are critical to the support of clinical staff in the health care industry. Physicians, nurses and other direct patient-contact personnel rely on well-trained medical office professionals to assist them in the creation, maintenance, and retention of quality medical documentation based on patient care. The medical office professional's job may include transcribing medical documents, creating and processing correspondence, scheduling patient appointments, scanning documents into digital health records, releasing patient information, collecting or abstracting medical data, understanding reimbursement methodologies, meeting physician documentation needs, and other related duties.

Applicants should possess excellent communication skills, meticulous attention to detail, good spelling, finger dexterity, and extreme accuracy in their work. Candidates considering this field should be comfortable reading and analyzing data for long periods of time, listening to dictated material for extended periods, assisting the patient documentation needs, and working on an independent basis.

Career Opportunities

Medical Office Professionals enjoy salaries in the top bracket of office professionals. Some may advance to office supervisors or managers with further education; and some may develop their own business based on their medical office specialty, such as transcription.

The Medical Office Professional may work in a physician's office, surgery center, specialty clinic, hospital, insurance company, government agency, research foundation, long-term care facility, dental office, consulting firm, rehabilitation center or other health care facility.

According to the Bureau of Labor Statistics, Medical Secretarial Occupations are anticipated to increase by +/- 22.5% between 2016 and 2026 (www.bls.gov).

Program Outcomes

1. Graduates will possess the knowledge and skills needed for employment as a Medical Office Professional.
2. Graduates will be proficient in the use of computer software applications, including advanced spreadsheet and database knowledge.
3. Graduates will possess an understanding of medical terminology, human disease, pharmacology, anatomy and physiology, patient confidentiality including HIPAA privacy rules, and will be able to professionally interact with healthcare providers and patients.
4. Graduates will transcribe/edit medical reports and related office correspondence.
5. Graduates of Medical Office Professional program are eligible to apply to write the Association for Healthcare Documentation Integrity, Registered Healthcare Documentation Specialist (RHDS) examination.

Program Faculty

Jennifer Anglin jennifer.anglin@saintpaul.edu

Part-time/Full-time Options

This program can be completed by using a combination of online, day, evening, and Saturday courses. Part-time and full-time options are available.

Program Requirements

- Check off when completed
 - All classes must be successfully completed with grade "C" or better.
- | <u>Course</u> | <u>Cr</u> |
|--|-----------|
| <input type="checkbox"/> BTEC 1421 Business Information Applications 1 . . . | 3 |
| <input type="checkbox"/> BTEC 1423 Business Information Applications 2 . . . | 4 |
| <input type="checkbox"/> BTEC 2410 Business Procedures | 4 |
| <input type="checkbox"/> BUSN 1410 Introduction to Business | 3 |
| <input type="checkbox"/> BUSN 1480 Business Career Resources | 1 |
| <input type="checkbox"/> MEDS 1420 Health Information Foundations | 3 |
| <input type="checkbox"/> MEDS 1470 Anatomy & Physiology/
Medical Office | 3 |
| <input type="checkbox"/> MEDS 1480 Medical Terminology | 3 |
| <input type="checkbox"/> MEDS 1551 Medical Formatting/Transcription 1 . . . | 3 |
| <input type="checkbox"/> MEDS 1552 Transcription and Documentation II . . . | 3 |
| <input type="checkbox"/> MEDS 1553 Advanced Medical Documentation . . . | 3 |
| <input type="checkbox"/> MEDS 1560 Computerized Health Information . . . | 3 |
| <input type="checkbox"/> MEDS 1570 Human Disease | 3 |
| <input type="checkbox"/> MEDS 2430 Pharmacology for the Medical Office . . | 2 |
| Subtotal | 41 |

General Education/MnTC Requirements Cr

- Refer to the Minnesota Transfer Curriculum Course List for each Goal Area
- Goal 1: Communication 7
ENGL 1711 Composition 1 – 4 cr
COMM 17XX – 3 cr
 - Goal 3 or Goal 4 3
Goal 3: Natural Sciences OR
Goal 4: Mathematical/Logical Reasoning
 - Goal 5: History, Social Science and Behavioral Sciences 3
 - Goal 6: Humanities and Fine Arts 3
 - Goals 1-10 of the Minnesota Transfer Curriculum . . 3
Select a minimum of 3 additional credits
- General Education Requirements 19**

Total Program Credits 60

Program Start Dates

Fall, Spring, Summer-limited course offerings

Course Sequence

The course sequence listed on the back of this guide is required.

*See back of this guide for
Course Sequence and Transfer Opportunities*

Minimum Program Entry Requirements

Students entering this program must meet the following minimum program entry requirements:

Reading: Score of 78+ or grade of "C" or better in READ 0722

Writing: Score of 78+ on Reading Comprehension or grade of "C" or better in ENGL 0922

Arithmetic: Score of 52+ or grade of "C" or better in MATH 0745

Keyboarding Skills: Minimum of 40 WPM with 3 errors or less or a grade of "C" or better in BTEC 1400.

Computer Skills: Basic computer skills such as word processing, spreadsheets, and Internet usage or a grade of "C" or better in BTEC 1418.

Assessment Results and Prerequisites: Students admitted into Saint Paul College programs may need to complete additional courses based on assessment results and course prerequisite requirements. Certain MATH, READ, and ENGL courses have additional prerequisites.

024A (7028)

*Information is subject to change.
This Program Requirements Guide is not a contract.*

Medical Office Professional AAS DEGREE *(continued)*

Course Sequence

The following sequence is recommended for a full-time student; however, this sequence is not required. Not all courses are offered each semester; a selection of courses is offered summer term.

All classes must be successfully completed with a grade of "C" or better.

First Semester (Year 1)

BTEC 1421 Business Information Applications 1	3
BUSN 1410 Introduction to Business	3
MEDS 1420 Health Information Foundations	3
MEDS 1470 Anatomy & Physiology/Medical Office	3
MEDS 1480 Medical Terminology	3
Total Semester Credits	15

Second Semester (Year 1)

BTEC 1423 Business Information Applications 2	4
MEDS 1570 Human Disease	3
Goal 1: ENGL 1711 Composition 1	4
Goal 6: Humanities and Fine Arts	3
Total Semester Credits	14

Third Semester (Year 2)

BTEC 2410 Business Procedures	4
MEDS 1551 Medical Formatting/Transcription 1	3
MEDS 1552 Transcription And Documentation II	3
Goal 1: COMM 17XX	3
Goal 3: Natural Sciences	
OR Goal 4: Mathematical/Logical Reasoning	3
Total Semester Credits	16

Fourth Semester (Year 2)

BUSN 1480 Business Career Resources	1
MEDS 1553 Advanced Medical Documentation	3
MEDS 1560 Computerized Health Information	3
MEDS 2430 Pharmacology for the Medical Office	2
Goal 5: History, Social Sciences and Behavioral Sciences	3
Goals 1-10: Minnesota Transfer Curriculum	3
Total Semester Credits	15

Total Program Credits60

Transfer Opportunities

Saint Paul College has a transfer articulation agreement between the following program and post-secondary institutions for the baccalaureate degree programs listed below.

For more information please go to saintpaul.edu/Transfer.

Medical Office Professional AAS

BA	Health Care Administration Concordia University, St. Paul
BA	Individualized Studies Metropolitan State University
BS	Healthcare Management Herzing University
BS	Healthcare and Human Service Management Saint Mary's University, Twin Cities Campus

Medical Coding DIPLOMA

Program Overview

Graduates of the Medical Coding Diploma program are proficient in coding diagnoses and procedures, abstracting medical data, meeting physician documentation needs, and other related duties. Coders work closely with billing personnel at healthcare facilities, and proficiency in billing and reimbursement procedures is included in the Medical Coding Diploma program. Courses taken to meet requirements for the Medical Coding Diploma also prepare a student to continue into the Health Information Technology AAS degree program.

Applicants should possess excellent communication skills, meticulous attention to detail, good spelling, finger dexterity, and extreme accuracy in their work. Candidates considering this field should be comfortable reading and analyzing data for long periods of time, abstracting information from patient health records, assisting billers and other reimbursement personnel, and using critical thinking skills.

Career Opportunities

Graduates of the Medical Coding Diploma program may work in a physician's office, surgery center, specialty clinic, hospital, insurance company, government agency, research foundation, long-term care facility, dental office, consulting firm, rehabilitation center or other health care facility. Medical coding may be done at home through use of a secure Internet connection. Working from one's home is generally for employees who have completed training in an office setting for a period of time.

According to the Bureau of Labor Statistics, the Job Outlook for Medical Record and Health Information Technology careers is projected to increase 13.5% between 2016 and 2026, which is much faster than average (www.bls.gov).

Program Outcomes

1. Graduates will possess the knowledge and skills for employment as a medical coding specialist.
2. Graduates will be proficient in the use of computer software applications to assist in assigning diagnoses and procedures.
3. Graduates will possess a knowledge of medical terminology, anatomy and physiology, patient confidentiality, ethical standards of coding, and electronic health record applications to perform in a healthcare environment.

*Information is subject to change.
This Program Requirements Guide is not a contract.*

Program Faculty

Kelly Dale kelly.dale@saintpaul.edu

Part-time/Full-time Options

This program can be completed by using a combination of online, day, evening, and Saturday courses. Part-time and full-time options are available.

Program Requirements

- Check off when completed
- All classes must be successfully completed with grade "C" or better.

Technical Requirements Cr

- MEDS 1420 Health Information Foundations.3
- MEDS 1470 Anatomy & Physiology/
Medical Office3
- MEDS 1480 Medical Terminology3
- MEDS 1560 Computerized Health Information3
- MEDS 1562 Billing and Reimbursement2
- MEDS 1570 Human Disease.3
- MEDS 2430 Pharmacology for the
Medical Office2
- MEDS 2434 Legal and Ethical Aspects of
Health Information2
- MEDS 2461 ICD-10-CM Coding.3
- MEDS 2462 ICD-10-PCS Coding4
- MEDS 2470 CPT-4 Coding3
- MEDS 2480 Advanced Coding.3
- MEDS 2594 Medical Coding Capstone3
- Subtotal. 37**

General Education/MnTC Requirements Cr

- Refer to the Minnesota Transfer Curriculum Course List for each Goal Area
- Goal 1: Communications3
 - COMM 17XX – 3 cr
 - General Education Requirements 3**

Total Program Credits 40

Program Start Dates

Fall, Spring, Summer-limited course offerings

Course Sequence

The following sequence is recommended; however, this sequence is not required. Not all courses are offered each semester.

First Semester

- MEDS 1420 Health Information Foundations3
- MEDS 1470 Anatomy & Physiology/
Medical Office3
- MEDS 1480 Medical Terminology.3
- Goal 1: COMM 17XX3
- Total Semester Credits. 12**

Second Semester

- MEDS 1562 Billing and Reimbursement.2
- MEDS 1570 Human Disease3
- MEDS 2461 ICD-10-CM Coding3
- MEDS 2462 ICD-10-PCS Coding4
- MEDS 2470 CPT-4 Coding3
- Total Semester Credits. 15**

Third Semester

- MEDS 1560 Computerized Health Information3
- MEDS 2430 Pharmacology for the
Medical Office2
- MEDS 2434 Legal and Ethical Aspects of
Health Information2
- MEDS 2480 Advanced Coding3
- MEDS 2594 Medical Coding Capstone3
- Total Semester Credits. 13**

Total Program Credits 40

Minimum Program Entry Requirements Students entering this program must meet the following minimum program entry requirements:

Reading: Score of 78+ or grade of "C" or better in READ 0722

Writing: Score of 78+ on Reading Comprehension or grade of "C" or better in ENGL 0922

Arithmetic: Score of 52+ or grade of "C" or better in MATH 0745

Keyboarding Skills: Minimum of 40 WPM with 3 errors or less or a grade of "C" or better in BTEC 1400.

Computer Skills: Basic computer skills such as word processing, spreadsheets, and Internet usage or a grade of "C" or better in BTEC 1418.

Assessment Results and Prerequisites: Students admitted into Saint Paul College programs may need to complete additional courses based on assessment results and course prerequisite requirements. Certain MATH, READ, and ENGL courses have additional prerequisites.

330D (7189)

Medical Office CERTIFICATE

Program Overview

Graduates of the Medical Office certificate assist with scanning information into electronic health records, releasing patient information, meeting physician documentation needs, scheduling patients, and other related duties.

High school graduation or equivalent is required. Applicants should possess excellent communication skills, meticulous attention to detail, good spelling, finger dexterity, and extreme accuracy in their work. Candidates considering this field should be comfortable reading and analyzing data, assisting with patient concerns, and working with computer programs.

Career Opportunities

Graduates of the Medical Office Certificate program may work in physician offices, surgery centers, specialty clinics, hospital, insurance companies, government agencies, research foundations, long-term care facilities, dental offices, consulting firms, rehabilitation centers or other health care facilities. Other places of employment include working for vendors of computer software.

According to the Bureau of Labor Statistics, Medical Secretarial Occupations are anticipated to increase by +/- 22.5% between 2016 and 2026 (www.bls.gov).

Program Outcomes

1. Graduates will possess the knowledge and skills for employment as a Medical Office worker.
2. Graduates will be proficient in the use of computer software applications, including patient scheduling and electronic health record applications.
3. Graduates will possess a knowledge of medical terminology, anatomy and physiology, and confidentiality of patient health information to perform in a healthcare environment.

Program Faculty

Jennifer Anglin jennifer.anglin@saintpaul.edu
 Kelly Dale kelly.dale@saintpaul.edu

Part-time/Full-time Options

This program can be completed by using a combination of online, day, evening, and Saturday courses. Part-time and full-time options are available.

Program Requirements

- Check off when completed
- All classes must be successfully completed with grade "C" or better.

Course	Cr
<input type="checkbox"/> BTEC 1421 Business Information Applications 1	3
<input type="checkbox"/> BTEC 1530 Communication Technology	4
<input type="checkbox"/> BUSN 1480 Business Career Resources	1
<input type="checkbox"/> MEDS 1420 Health Information Foundations	3
<input type="checkbox"/> MEDS 1470 Anatomy & Physiology/ Medical Office	3
<input type="checkbox"/> MEDS 1480 Medical Terminology	3
<input type="checkbox"/> MEDS 1560 Computerized Health Information	3
Total Program Credits	20

Program Start Dates

Fall, Spring, Summer-limited course offerings

Course Sequence

The following sequence is recommended; however, this sequence is not required. Not all courses are offered each semester; a selection of courses is offered summer term.

First Semester

BTEC 1421 Business Information Applications 1	3
MEDS 1420 Health Information Foundations	3
MEDS 1470 Anatomy & Physiology/ Medical Office	3
MEDS 1480 Medical Terminology	3
Total Semester Credits	12

Second Semester

BTEC 1530 Communication Technology (spring only)	4
BUSN 1480 Business Career Resources	1
MEDS 1560 Computerized Health Information	3
Total Semester Credits	8

Total Program Credits 20

Minimum Program Entry Requirements

Students entering this program must meet the following minimum program entry requirements prior to beginning the program:

Reading: Score of 78+ or grade of "C" or better in READ 0722

Writing: Score of 78+ on Reading Comprehension or grade of "C" or better in ENGL 0922

Arithmetic: Score of 52+ or grade of "C" or better in MATH 0745

Keyboarding Skills: Minimum of 40 WPM with 3 errors or less or a grade of "C" or better in BTEC 1400.

Computer Skills: Basic computer skills such as word processing, spreadsheets, and Internet usage or a grade of "C" or better in BTEC 1418.

Assessment Results and Prerequisites: Students admitted into Saint Paul College programs may need to complete additional courses based on assessment results and course prerequisite requirements. Certain MATH, READ, and ENGL courses have additional prerequisites.

329C (7188)

*Information is subject to change.
 This Program Requirements Guide is not a contract.*

Healthcare Documentation Specialist CERTIFICATE

Program Overview

Graduates of a certificate program in healthcare documentation are proficient in transcribing medical documents, creating and processing correspondence, assisting with release of information, meeting medical provider documentation needs, and other duties. Courses from the certificate are applicable toward the Medical Office Professional AAS degree.

Applicants should possess excellent communication skills, meticulous attention to detail, good spelling, finger dexterity, and extreme accuracy in their work. Candidates considering this field should be comfortable listening to dictated material for an extended periods, editing documents created through the use of voice recognition software, and possess knowledge of patient confidentiality regarding health information.

Career Opportunities

Healthcare documentation specialists may work in a physician's office, surgery center, specialty clinic, hospital, insurance company, government agency, research foundation, long-term care facility, dental office, consulting firm, rehabilitation center or other health care facility.

Program Outcomes

1. Graduates will possess the knowledge and skills for employment as a healthcare documentation specialist.
2. Graduates will be proficient in the use of computer software applications to create and edit medical documentation.
3. Graduates will transcribe reports and documents for a variety of healthcare specialties using knowledge of pharmacology, pathophysiology, laboratory and radiology testing.
4. Graduates will use knowledge of medical terminology, anatomy and physiology, and HIPAA guidelines on patient confidentiality to produce medical documentation in a healthcare environment.
5. Graduates of the Healthcare Documentation Specialist program are eligible to apply to write the Association for Healthcare Documentation Integrity, Registered Healthcare Documentation Specialist (RHDS) examination.

Program Faculty

Jennifer Anglin jennifer.anglin@saintpaul.edu

Part-time/Full-time Options

This program can be completed by using a combination of online, day, evening, and Saturday courses. Part-time and full-time options are available.

Program Requirements

Check off when completed

All classes must be successfully completed with grade of "C" or better.

Course	Cr
<input type="checkbox"/> BTEC 1421 Business Information Applications 1	3
<input type="checkbox"/> BUSN 1480 Business Career Resources	1
<input type="checkbox"/> MEDS 1420 Health Information Foundations.	3
<input type="checkbox"/> MEDS 1470 Anatomy & Physiology/ Medical Office	3
<input type="checkbox"/> MEDS 1480 Medical Terminology	3
<input type="checkbox"/> MEDS 1551 Medical Formatting/Transcription 1	3
<input type="checkbox"/> MEDS 1552 Transcription And Documentation II.	3
<input type="checkbox"/> MEDS 1553 Advanced Medical Documentation	3
<input type="checkbox"/> MEDS 1560 Computerized Health Information	3
<input type="checkbox"/> MEDS 1570 Human Disease.	3
<input type="checkbox"/> MEDS 2430 Pharmacology for the Medical Office	2
Total Program Credits	30

Program Start Dates

Fall, Spring, Summer-limited course offerings

Course Sequence

The following sequence is recommended; however, this sequence is not required. Not all courses are offered each semester; only a selection of courses is offered summer term.

First Semester

BTEC 1421 Business Information Applications 1	3
MEDS 1420 Health Information Foundations	3
MEDS 1470 Anatomy & Physiology/ Medical Office	3
MEDS 1480 Medical Terminology.	3
Total Semester Credits.	12

Second Semester

MEDS 1551 Medical Formatting/Transcription 1	3
MEDS 1552 Transcription And Documentation II.	3
MEDS 1570 Human Disease	3
MEDS 2430 Pharmacology for the Medical Office	2
Total Semester Credits.	11

Third Semester

BUSN 1480 Business Career Resources	1
MEDS 1553 Advanced Medical Documentation	3
MEDS 1560 Computerized Health Information	3
Total Semester Credits.	7

Total Program Credits 30

Minimum Program Entry Requirements

Students entering this program must meet the following minimum program entry requirements:

Reading: Score of 78+ or grade of "C" or better in READ 0722

Writing: Score of 78+ on Reading Comprehension or grade of "C" or better in ENGL 0922

Arithmetic: Score of 52+ or grade of "C" or better in MATH 0745

Keyboarding Skills: Minimum of 40 WPM with 3 errors or less or a grade of "C" or better in BTEC 1400.

Computer Skills: Basic computer skills such as word processing, spreadsheets, and Internet usage or a grade of "C" or better in BTEC 1418.

Assessment Results and Prerequisites: Students admitted into Saint Paul College programs may need to complete additional courses based on assessment results and course prerequisite requirements. Certain MATH, READ, and ENGL courses have additional prerequisites.

390C (7228)

*Information is subject to change.
This Program Requirements Guide is not a contract.*

Health Sciences Broad Field AS DEGREE

Program Overview

The Health Sciences Broad Field AS Degree is designed to provide general education courses for students interested in health sciences, but have not yet decided which specific health care field they intend to pursue.

Career Opportunities

Students enrolled in the Health Sciences Broad Field AS degree will acquire all of the skills and knowledge needed to provide a smooth transition into baccalaureate health-related programs such as:

- Community Health
- Nursing
- Dental Hygiene
- Social Work
- Health Education
- Food and Nutrition
- Exercise Science

Program Outcomes

1. Utilize the English language effectively to read, write, speak, and listen critically.
2. Develop the capacity to identify, discuss, and reflect upon social and behavioral issues.
3. Demonstrate comprehension of human and biological systems.
4. Enhance mathematical and logical thinking techniques.
5. Improve their awareness and understanding of health, wellness, and liberal arts.

Program Faculty

Brendan Ashby brendan.ashby@saintpaul.edu

Program Requirements

Check off when completed

Course	Cr
<input type="checkbox"/> BIOL 1740 General Biology 1: The Living Cell	5
<input type="checkbox"/> BIOL 1760 Nutrition	3
<input type="checkbox"/> BIOL 2721 Human Anatomy and Physiology 1	4
<input type="checkbox"/> BIOL 2722 Human Anatomy and Physiology 2	4
<input type="checkbox"/> BIOL 2750 General Microbiology	4
<input type="checkbox"/> CHEM 1711 Principles of Chemistry 1	4
<input type="checkbox"/> COMM 1720 Interpersonal Communication	3
<input type="checkbox"/> ENGL 1711 Composition 1	4
<input type="checkbox"/> MATH 1730 College Algebra	3
<input type="checkbox"/> MATH 1740 Introduction to Statistics	4
<input type="checkbox"/> PHIL 1722 Health Care Ethics	3
<input type="checkbox"/> PSYC 1710 General Psychology	4
<input type="checkbox"/> PSYC 1720 Psychology throughout the Lifespan	3
<input type="checkbox"/> SOCI 1710 Introduction to Sociology	4
Subtotal	52
<hr/>	
General Education/MnTC Requirements	Cr
Refer to the Minnesota Transfer Curriculum Course List for each Goal Area	
<input type="checkbox"/> Liberal Arts or Science Electives (MnTC only)	8
Select a minimum of 8 additional credits from Goals 1-10 of the Minnesota Transfer Curriculum.	
General Education Requirements	8
Total Program Credits	60

Minimum Program Entry Requirements

Students entering this program must meet the following minimum program entry requirements:

Reading: Score of 78+ or a grade of "C" or better in READ 0722

Writing: Score of 78+ or a grade of "C" or better in ENGL 0922

College Level Mathematics: Score of 50+ or grade of "C" or better in MATH 0920

Assessment Results and Prerequisites:

Students admitted into Saint Paul College programs may need to complete additional courses based on assessment results and course prerequisite requirements. Certain MATH, BIOL, and CHEM courses have additional prerequisites.

341S (7194)

Program Start Dates

Fall, Spring, Summer

Course Sequence

The following sequence is recommended for a full-time student; however, this sequence is not required.

First Semester

BIOL 1740 General Biology 1: The Living Cell	5
BIOL 1760 Nutrition	3
ENGL 1711 Composition 1	4
MATH 1730 College Algebra	3
Total Semester Credits	15

Second Semester

BIOL 2721 Human Anatomy and Physiology 1	4
CHEM 1711 Principles of Chemistry 1	4
COMM 1720 Interpersonal Communication	3
PHIL 1722 Healthcare Ethics	3
Total Semester Credits	14

Third Semester

BIOL 2722 Human Anatomy and Physiology 2	4
MATH 1740 Introduction to Statistics	4
PSYC 1710 General Psychology	4
Goals 1-10: Minnesota Transfer Curriculum	4
Total Semester Credits	16

Fourth Semester

BIOL 2750 General Microbiology	4
PSYC 1720 Psychology throughout the Lifespan	3
SOCI 1710 Introduction to Sociology	4
Goals 1-10: Minnesota Transfer Curriculum	4
Total Semester Credits	15

Total Program Credits 60

Transfer Opportunities

Saint Paul College has a transfer articulation agreement between the following program and post-secondary institutions for the baccalaureate degree programs listed below.

See back of this guide for Transfer Opportunities

Information is subject to change.
This Program Requirements Guide is not a contract.

Health Sciences Broad Field AS DEGREE *(continued)*

Transfer Opportunities

Saint Paul College has a transfer articulation agreement between the following program and post-secondary institutions for the baccalaureate degree programs listed below.

For more information please go to saintpaul.edu/Transfer.

Health Sciences Broad Field AS

BA	Health Care Administration Concordia University, St. Paul
BA	Biology Concordia University, St. Paul
BAS	Health Services Management University of Minnesota, College of Continuing and Professional Studies
BS	Athletic Training, Community Health, Social Work St. Cloud State University
BS	Biology Concordia University, St. Paul
BS	Biology, Health, Exercise and Rehabilitative Sciences, Movement Sciences, Exercise Science, Health Promotion, Community Health, Nursing (limited) Winona State University
BS	Communication Disorders, Foods and Nutrition, Dental Hygiene (limited), Therapeutic Recreation, Dietetics, Nursing (limited), Corrections, Psychology, Health Science, Social Work Minnesota State University, Mankato
BS	Community Health, Exercise Science, Nursing (limited) Bemidji State University
BS	Exercise Science Southwest Minnesota State University
BS	Exercise Science, Health Teacher Education Minnesota State University, Moorhead
BS	Human Biology Northwestern Health Sciences University
BSN	Nursing (limited) Metropolitan State University

Medical Laboratory Technician AAS DEGREE

Program Overview

The Medical Laboratory Technician program is a combination of classroom, laboratory and applied experiences that will provide students with training needed for employment in Medical Laboratory careers. Following the didactic coursework, which includes hands-on training in campus student laboratories, students are assigned to a clinical affiliate for the clinical experience. This required portion of the curriculum provides realistic experiences and an opportunity for further learning and demonstration of technical and affective skill competency. The Associate of Applied Science Degree earned prepares graduates to enter employment as a Medical Laboratory Technician or continue their education to earn a baccalaureate degree as a Medical Laboratory Scientist. Medical Laboratory Technicians use sophisticated automated equipment and instruments, microscopes and cell counters to perform testing that helps physicians diagnose illness and disease, and treat and monitor patient health and wellness. They collect and prepare specimens; count cells and look for abnormal cells; analyze the chemical content of fluids; look for bacteria, parasites or other microorganisms; and match blood for transfusions. As a critical member of the healthcare team, Medical Laboratory Technicians evaluate data to determine its accuracy and relay the test results to the physician to provide quality services that contribute to patient safety. They then analyze the results and relay them to physicians. Qualifications include an interest and aptitude in science and mathematics, accuracy and attention to detail, strong communication skills, moral and intellectual integrity, self-discipline, an ability to multitask and prioritize workload, and desire to contribute to quality patient care. Laboratory workers must have the cognitive and technical skills to perform and master a variety of tasks and the professional/affective skills to work efficiently and interact effectively with patients and other members of the healthcare team.

Career Opportunities

Laboratory tests are of vital importance to modern medical practice. The need for clinical laboratory workers is expected to remain strong. Increased job openings are expected due to the increased need for laboratory testing in an aging population and also due to vacancies created through retirements of current employees. Employment of medical laboratory professionals is projected to grow 16% from 2014 to 2024 (according to the U.S. Bureau of Labor Statistics). Medical Laboratory Technicians are employed in hospital laboratories, clinics, doctor's offices, public health agencies and pharmaceutical, industrial, and medical research laboratories.

Program Outcomes

1. The graduate will demonstrate proper use, calibration, adjustment, and operation of most laboratory precision instrumentation including clinical microscopes, spectrophotometers, centrifuges, computers, and automated laboratory analyzers.

2. The graduate will demonstrate standard safety practices in the medical laboratory designed to prevent injury, illness, or loss of life to those working in and/or around medical laboratory equipment with particular emphasis on the skills required for collection and testing of numerous body fluids and specimens using Standard Precautions (including the use of personal protective equipment).
3. The graduate will correlate pathological conditions of the human body, including cause and symptoms, to the laboratory's role in diagnosis and treatment.
4. The graduate will demonstrate organized work skills as reflected in efficient time and material utilization while performing proficiently and safely in the clinical environment.
5. The graduate will perform a wide variety of testing procedures employed in a medical laboratory and relate the principles of quality assurance and the importance of these procedures to patient safety and the diagnosis and treatment of disease processes in the following areas: clinical chemistry, hematology and hemostasis, urinalysis, microbiology, immunohematology (transfusion medicine) and immunology.
6. The graduate will be prepared to take the examination administered by the Board of Certification under the direction of the American Society for Clinical Pathology (ASCP).
7. The graduate will demonstrate preparedness for entry level employment as a Medical Laboratory Technician, including both technical expertise and professionalism.

National Certification Exam

Upon completion of the program, the student is eligible to take an examination administered by the Board of Certification under the direction of the American Society for Clinical Pathology (ASCP).

Textbook and Supply Costs

Students should expect to spend approximately \$2,400.00, beyond the cost of tuition and fees, for books, supplies, certification exam, and liability insurance.

Part-time and Full-time Options

Many students attend part-time, which usually increases the program length to 3 years. Part-time students take required general education courses prior to enrolling in the MDLT courses. Once admitted to the MLT Major, students must take all of the required MDLT courses in sequence as prescribed. Technical courses are offered only during the day. Students completing the required General Education, developmental or EAPP courses and who have not been officially admitted to the MLT program are considered Pre-Medical Laboratory Technician.

Application Process

After completing the Saint Paul College application

and admission process, students interested in the Medical Laboratory Technician program must submit a completed Application to the Medical Laboratory Technician Program form to One Stop. This form is available on the Medical Laboratory Technician Web page (saintpaul.edu/MLT) on the second Wednesday of fall semester through the last day in January. This application window is for the subsequent fall semester start in the MLT Major. Applicants must meet the following criteria to submit the form:

- Documented readiness for, or completion of, the following required General Education Courses: ENGL 1711 English Composition and CHEM 1711 Principles of Chemistry 1
- Achieve a cumulative GPA of 2.8 or better with a minimum grade of "C" in all college level courses.

Admission into the Program

Applying by the priority application deadline (listed on the application) does not guarantee admission to the Medical Laboratory Technician Program. Being admitted to Saint Paul College does not imply admission into the Medical Laboratory Technician Program. After the priority review deadline indicated on the Application to the Medical Laboratory Technician Major, each application is reviewed in the order submitted on the basis of overall academic ability, GPA of college level courses, and assessment scores. Applicants are admitted on a first-qualified, first-served basis according to the order of application submission. Notification of acceptance into the Medical Laboratory Technician Major will be sent by mail 6 weeks after the deadline date listed on the Application to the Medical Laboratory Technician form. Students admitted into the Medical Laboratory Technician program must attend a mandatory orientation meeting (MLT Seminar) to complete documentation to enter the program.

See back of this guide for Program Requirements, Course Sequence and Transfer Opportunities

Minimum Program Entry Requirements

Students entering this program must meet the following minimum program entry requirements:

Reading: Score of 78+ or grade of "C" or better in READ 0722

Writing: Score of 78+ on Reading Comprehension or grade of "C" or better in ENGL 0922

College Level Mathematics: Score of 50+ or grade of "C" or better in MATH 0920

Assessment Results and Prerequisites:

Students admitted into Saint Paul College programs may need to complete additional courses based on assessment results and course prerequisite requirements. Certain MATH, READ, and ENGL courses have additional prerequisites.

061A 622A (7044)

Medical Laboratory Technician AAS DEGREE *(continued)*

Program Faculty

Michelle Briski michelle.briski@saintpaul.edu
 Nicole Schroeder
 nicole.schroeder@saintpaul.edu

Students should consult with the program advisor to develop an appropriate educational plan.

Program Requirements

Check off when completed

All classes must be successfully completed with a grade of "C" or better.

MDLT Core Courses Cr

MDLT Core Courses can only be taken by students who have been officially accepted and admitted into the Medical Laboratory Technician Program.

- HLTH 1410 Medical Terminology 1
- MDLT 1400 Orientation 1
- MDLT 1410 Laboratory Techniques 3
- MDLT 1421 Hematology 1 2
- MDLT 1422 Hematology 2 4
- MDLT 1430 Urinalysis/Body Fluids 3
- MDLT 1441 Clinical Chemistry 1 2
- MDLT 1442 Clinical Chemistry 2 4
- MDLT 1446 Phlebotomy 1
- MDLT 1510 Immunology 2
- MDLT 2410 Immunohematology 3
- MDLT 2420 Clinical Microbiology 4
- MDLT 2430 Clinical Practice Orientation 1
- MDLT 2500 Molecular Diagnostics/Advanced Body Fluid Analysis 2
- MDLT 2591 Clinical Practice 9
- MDLT 2593 Comprehensive Examinations 1
- MDLT Core Credits Subtotal 43**

General Education/MnTC Requirements Cr

Refer to the Minnesota Transfer Curriculum Course List for each Goal Area

- Goal 1: Communication 7
 ENGL 1711 Composition 1 – 4 cr
 COMM 17XX - 3 cr
- Goal 3: Natural Sciences 16
 BIOL 1730 Human Body Systems – 3 cr
 BIOL 1740 General Biology 1: The Living Cell – 5 cr
 CHEM1711 Principles of Chemistry 1 – 4 cr
 CHEM1712 Principles of Chemistry 2 – 4 cr
- Goal 5: History, Social Science and Behavioral Sciences 3
 PSYC 1710 General Psychology OR
 SOCI 1720 Social Problems (recommended)
- Goal 6: Humanities and Fine Arts. 3
 PHIL 1722 Health Care Ethics (recommended)
- General Education Requirements 29**

Total Program Credits 72

Information is subject to change.
 This Program Requirements Guide is not a contract.

Recommended Supplemental Courses

The following optional Learning Lab courses reinforce the basic skills required for attaining proficiency in performing medical laboratory procedures:

- MDLT 1451 Learning Lab 1 – Introductory Skills. 1
- MDLT 1452 Learning Lab 2 – Introductory Skills. 1
- MDLT 1453 Learning Lab 3 – Intermediate Skills 1
- MDLT 1454 Learning Lab 4 – Intermediate Skills 1
- MDLT 2455 Learning Lab 5 – Advanced Skills 1
- MDLT 2456 Learning Lab 6 – Advanced Skills 1

Program Start Dates

Fall

Course Sequence

The following Course Sequence is required for full-time students. MDLT Core Courses can only be taken by students who have been officially accepted and admitted into the Medical Laboratory Technician program and who have attended the Mandatory Medical Lab Technician Seminar.

Accepted students progress through the major as a cohort and must take MDLT courses in sequence in the semester indicated. Non-MDLT coursework can be taken prior to acceptance into the MLT Major or during the semester indicated in the presented course sequence.

Students should consult with the program advisor to develop an appropriate educational plan. HLTH 1410 Medical Terminology must be completed by the end of the first semester in the MLT Major.

Not all courses are offered each semester. MDLT coursework can be started only Fall semester.

First Semester

- HLTH 1410 Medical Terminology 1
- MDLT 1400 Orientation. 1
- MDLT 1410 Laboratory Techniques. 3
- MDLT 1421 Hematology 1 2
- MDLT 1430 Urinalysis/Body Fluids 3
- MDLT 1441 Clinical Chemistry 1 2
- MDLT 1446 Phlebotomy 1
- Goal 3: CHEM 1711 Principles of Chemistry 1 4
- Goal 3: BIOL 1730 Human Body Systems. 3
- Total Semester Credits. 20**

Recommended Supplemental Courses First Semester:

- MDLT 1451 Learning Lab 1 (Optional) 1
- MDLT 1452 Learning Lab 2 (Optional) 1

Second Semester

- MDLT 1422 Hematology 2 4
 - MDLT 1442 Clinical Chemistry 2 4
 - MDLT 1510 Immunology. 2
 - Goal 3: CHEM 1712 Principles of Chemistry 2 4
 - Goal 3: BIOL 1740 General Biology 1 5
 - Total Semester Credits. 19**
- Recommended Supplemental Courses Second Semester:
- MDLT 1453 Learning Lab 3 (Optional) 1
 - MDLT 1454 Learning Lab 4 (Optional) 1

Third Semester

- Goal 1: COMM 17XX 3
- Goal 1: ENGL 1711 Composition 1 4
- Total Summer Term Credits 7**

Fourth Semester (Year 2)

- MDLT 2410 Immunohematology. 3
- MDLT 2420 Clinical Microbiology 4
- MDLT 2430 Clinical Practice Orientation 1
- MDLT 2500 Molecular Diagnostics/Advanced Body Fluid Analysis 2
- Goal 5: PSYC 1710 or SOCI 1720 recommended. 3
- Goal 6: PHIL 1722 Health Care Ethics recommended. 3
- Total Semester Credits. 16**

Recommended Supplemental Courses Fourth Semester:

- MDLT 2455 Learning Lab 5 (Optional) 1
- MDLT 2456 Learning Lab 6 (Optional) 1

Fifth Semester (Year 2)

- MDLT 2591 Clinical Practice 9
- Total Semester Credits. 9**

Sixth Semester

- MDLT 2593 Comprehensive Examinations 1
- Total Summer Term Credits 1**

Total Program Credits 72

Transfer Opportunities

Saint Paul College has a transfer articulation agreement between the following program and post-secondary institutions for the baccalaureate degree programs listed below.

For more information please go to saintpaul.edu/Transfer.

Medical Laboratory Technician AAS

- BA Health Care Administration
 Concordia University, St. Paul
- BA Individualized Studies
 Metropolitan State University
- BS Clinical Laboratory Science
 Winona State University
- BS Healthcare and Human Service Management
 Saint Mary's University,
 Twin Cities Campus
- BS Medical Laboratory Science
 University of North Dakota

This program is accredited by the National Accrediting Agency for Clinical Laboratory Sciences (NAACLS):

5600 N River RD, Suite 720
 Rosemount, IL 60018-5119
 Telephone: 773.714.8880
 Fax: 773.714.8886
 E-mail: info@naacils.org
 website: www.naacils.org

Phlebotomy Technician CERTIFICATE

Program Overview

The Phlebotomy Technician program is a combination of classroom, laboratory and applied experiences that will provide students with the training needed for employment in phlebotomy careers. Following the on-campus phlebotomy didactic coursework, students are assigned to a clinical affiliate for the clinical experience. This required portion of the curriculum provides an opportunity for demonstration of technical and affective skill competency. Students spend 100 hours at the affiliate where they must perform a minimum of 100 successful blood collection procedures, under the supervision of affiliate staff.

After program completion, graduates are eligible to take the Phlebotomy Technician Certification examination administered through the American Society of Clinical Pathology (ASCP) Board of Certification.

Phlebotomy technicians serve an integral role as members of the healthcare team. Phlebotomy is an entry level position in healthcare. Trained to collect blood specimens from patients, Phlebotomy technicians are skilled professionals who assist physicians in diagnosis and treatment of disease by ensuring the high quality of the specimen they provide for laboratory analysis. They practice safety to protect themselves and the patients they serve. Additionally, because phlebotomy involves significant direct patient contact, these laboratory professionals become the face of the laboratory and must adhere to standards of professional behavior and appearance.

Qualifications include an ability to work accurately under pressure, and to communicate effectively. Phlebotomy technicians like challenge and responsibility and are committed to providing high quality care to patients.

Employment growth in this field is faster than average and is expected to increase by 27% from 2012 – 2022 according to the National Bureau of Labor Statistics.

Career Opportunities

Phlebotomy technicians are employed in a variety of settings including hospitals, clinics, blood donation centers and other outpatient care centers.

Program Outcomes

1. The graduate will demonstrate proper selection and use of phlebotomy equipment for safe specimen procurement that maintains optimal specimen integrity.
2. The graduate will demonstrate awareness of and ability to respond to complications or special considerations.
3. The graduate will demonstrate standard safety practices designed to prevent injury or illness using Standard Precautions (including the use of Personal Protective Equipment).
4. The graduate will demonstrate effective interpersonal/professional/self-management skills to fulfill his/her job responsibilities in interactions with patients, colleagues and other members of the health care team.
5. The graduate will be prepared to take the examination administered by the Board of Certification under the direction of the American Society for Clinical Pathology (ASCP).
6. The graduate will demonstrate preparedness for entry level employment as a phlebotomy technician.

Additional Program Requirements

- Grade of "C" (2.0) or higher in all courses with A/F grading criteria
- Pass (P) grade demonstrating satisfactory performance in meeting skill competencies in the PHLB clinical experience course
- Evidence of immunity to specified diseases
- Passing of a criminal background study prior to being placed in a PHLB clinical experience. The College cannot guarantee placement in clinical experiences for students who do not have a clear background study. For more information about the background study process and disqualifying crimes, contact the Minnesota Department of Human Services at 651.296.3802.

Textbook and Supply Costs

Students should expect to spend approximately \$680.00 beyond the cost of tuition and fees, for books, supplies, certification exam and liability insurance. Students are responsible for parking and transportation costs for the clinical experience portion of the program.

Required Phlebotomy Technician Certificate Seminar

Students must attend a mandatory Phlebotomy Seminar to complete required documentation during the first week of the second semester PHLB courses.

Program Faculty

Nicole Schroeder

nicole.schroeder@saintpaul.edu

Program Requirements

- Check off when completed
- All courses must be successfully completed with a grade of "C" or better.
- Individuals must be at least 18 years of age
- Students must attend a mandatory Phlebotomy Seminar to complete required documentation during the first week of the second semester PHLB courses.

Course	Cr
<input type="checkbox"/> BIOL 1730 Human Body Systems	3
<input type="checkbox"/> COMM 1710 Fundamentals of Public Speaking OR COMM 1720 Interpersonal Communication.	3
<input type="checkbox"/> HLTH 1410 Medical Terminology.	1
<input type="checkbox"/> HLTH 1575 EKG & Telemetry	6
<input type="checkbox"/> PHIL 1722 Health Care Ethics	3
<input type="checkbox"/> PHLB 1405 Phlebotomy	4
<input type="checkbox"/> PHLB 1410 Phlebotomy Clinical Experience.	2

Total Program Credits 22

See back of this guide for Program Requirements, and Course Sequence

Minimum Program Entry Requirements

Students entering this program must be at least 18 years of age and meet the following minimum program entry requirements:

Reading: Score of 78+ on Reading Comprehension or grade of "C" or better in READ 0722

Writing: Score of 78+ on Reading Comprehension or grade of "C" or better in ENGL 0922

Arithmetic: Score of 31+ or grade of "C" or better in MATH 0745

Assessment Results and Prerequisites: Students admitted into Saint Paul College programs may need to complete additional courses based on assessment results and course prerequisite requirements. Certain MATH, READ, and ENGL courses have additional prerequisites.

(7195) 339C

*Information is subject to change.
This Program Requirements Guide is not a contract.*

Phlebotomy Technician CERTIFICATE *(continued)*

Program Start Dates

Fall, Spring

Course Sequence

This certificate must be completed in two semesters as shown in the following sequence. All prerequisite/first semester courses must be completed before PHLB 1405 and PHLB 1410. HLTH 1575 can be taken with PHLB courses or before.

Students must enroll in PHLB 1405 Phlebotomy and PHLB 1410 Phlebotomy Clinical Experience within the same semester to allow immediate progression to the Phlebotomy Clinical Experience following completion of on campus training. PHLB courses must be taken following successful completion of all prerequisite/first semester course requirements with a grade of "C" or better.

The clinical experience is Monday-Friday and typically occurs during daytime operational hours of our affiliated clinical sites. Students must schedule any courses being taken concurrently with PHLB 1410 accordingly with evening, weekend, or online courses offerings.

First Semester:

BIOL 1730 Human Body Systems	3
COMM 1710 Fundamentals of Public Speaking OR	
COMM 1720 Interpersonal Communication	3
HLTH 1410 Medical Terminology	1
PHIL 1722 Health Care Ethics	3
Total Semester Credits	10

All First Semester courses must be successfully completed with a grade of "C" or better before proceeding to PHLB courses.

Must attend a mandatory Phlebotomy Seminar to complete required documentation during the first week of the second semester PHLB courses.

Second Semester:

HLTH 1575 EKG & Telemetry	6
PHLB 1405 Phlebotomy	4
PHLB 1410 Phlebotomy Clinical Experience	2
Total Semester Credits	12

Total Program Credits22

Readmission to the Program

Students who intend to be readmitted to the program, after leaving before completing all requirements, must schedule an appointment to meet with the PHLB Program Director before registering for the phlebotomy classes. Readmit applicants are considered on a space available basis. Being readmitted to Saint Paul College does not imply readmission to the Phlebotomy Technician Certificate program.

Patient Care Technician AAS DEGREE

Program Overview

Patient Care Technicians or PCTs work with doctors, nurses and other health care professionals to provide direct patient care in a variety of health care environments. The responsibilities of a patient care technician include caring for injured, physically ill, mentally ill, and disabled patients in hospitals, nursing homes, assisted living communities, physicians' offices, long-term care or other medical facilities. Graduates who complete this specialized training from Saint Paul College may go on to further advancement in the medical field, by way of becoming a certified Patient Care Technician. The Patient Care Technician program offers opportunities to individuals interested in entering the health care field and to those currently employed in the field who wish to seek additional credentials to complement their current skill set.

Licensing or certification exams are independent of graduation requirements. Successful students will be eligible to obtain five certifications:

1. Registered Nursing Assistant & Home Health Aide (NA-R)
2. Trained Medication Aide (TMA)
3. Certified EKG Technician (CET)
4. Phlebotomy Certification
5. Certified Patient Care Technician (CPCT)

Career Opportunities

Employment of similar occupations, such as nursing assistants and orderlies, is projected to grow 11 percent from 2016 to 2026, faster than the average for all occupations. As the babyboom population ages, nursing assistants and orderlies will be needed to assist and care for elderly patients.

Program Outcomes

1. Demonstrate knowledge and skills necessary to function as a member of the health care team.
2. Explain how the Health Insurance Portability and Accountability Act (HIPAA) compliance regulation impacts workers in the health care industry.
3. Interact with clients, their support persons, and the health care team using appropriate communication techniques.
4. Institute and maintain principles of infection control.
5. Demonstrate professionalism and ethical conduct in the workplace.
6. Become employed in the healthcare industry.

Program Faculty

Brendan Ashby brendan.ashby@saintpaul.edu

Program Requirements

Check off when completed

Course	Cr
<input type="checkbox"/> HLTH 1410 Medical Terminology	1
<input type="checkbox"/> HLTH 1432 Basic Life Support for Health Care Providers	1
<input type="checkbox"/> HLTH 1570 Trained Medication Aide	2
<input type="checkbox"/> HLTH 1575 EKG & Telemetry	6
<input type="checkbox"/> HLTH 1580 Medical Office Skills for the Patient Care Technician.	3
<input type="checkbox"/> HLTH 1585 Job Readiness/Certification Exam Preparation	2
<input type="checkbox"/> NAST 1111 Nursing Assistant & Home Health Aide	4
<input type="checkbox"/> NAST 1112 Nursing Assistant Clinical	1
<input type="checkbox"/> PHLB 1405 Phlebotomy	4
<input type="checkbox"/> PHLB 1410 Phlebotomy Clinical Experience	2
Subtotal	26

General Education/MnTC Requirements

Refer to the Minnesota Transfer Curriculum Course List for each Goal Area

<input type="checkbox"/> Goal 1: Communication	7
ENGL 1711 Composition 1 – 4 cr	
COMM 1720 Interpersonal Communication – 3 cr	
<input type="checkbox"/> Goal 3: Natural Sciences	17
BIOL 1740 General Biology 1: The Living Cell – 5 cr	
BIOL 2721 Human Anatomy and Physiology 1 – 4 cr	
BIOL 2722 Human Anatomy and Physiology 2 – 4 cr	
BIOL 2750 General Microbiology – 4 cr	
<input type="checkbox"/> Goal 5: History, Social Science and Behavioral Sciences	7
PSYC 1720 Psychology Throughout the lifespan – 3 cr	
SOCI 1710 Introduction to Sociology – 4 cr	
<input type="checkbox"/> Goal 6: Humanities and Fine Arts.	3
PHIL 1722 Health Care Ethics – 3 cr	
General Education Requirements	34

Total Program Credits 60

Program Start Dates

Fall, Spring, Summer

Course Sequence

This course sequence is recommended for a fulltime student; however, this sequence is not required. Contact Program Faculty with questions.

See back of this guide for Program Requirements, and Course Sequence

Minimum Program Entry Requirements

Students entering this program must meet the following minimum program entry requirements:

Reading: Score of 78+ or a grade of "C" or better in READ 0722

Writing: Score of 78+ or a grade of "C" or better in ENGL 0922

Arithmetic: Score of 31+ or grade of "C" or better in MATH 0745

Assessment Results and Prerequisites: Students admitted into Saint Paul College programs may need to complete additional courses based on assessment results and course prerequisite requirements. Certain MATH, BIOL, and CHEM courses have additional prerequisites.

387A (7219)

*Information is subject to change.
This Program Requirements Guide is not a contract.*

Patient Care Technician AAS DEGREE *(continued)*

Course Sequence

This course sequence is recommended for a fulltime student; however, this sequence is not required. Contact Program Faculty with questions.

First Semester

BIOL 1740 General Biology 1	5
COMM 1720 Interpersonal Communication	3
HLTH 1410 Medical Terminology	1
HLTH 1432 Basic Life Support for Health Care Providers	1
PSYC 1720 Psychology Throughout the lifespan	3
Total Semester Credits	13

Second Semester

BIOL 2721 Human Anatomy and Physiology 1	4
ENGL 1711 Composition 1	4
HLTH 1580 Medical Office Skills for the Patient Care Technician	3
PHIL 1722 Health Care Ethics	3
Total Semester Credits	14

Third Semester (Summer Session)

NAST 1111 Nursing Assistant & Home Health Aide	4
NAST 1112 Nursing Assistant Clinical	1
Total Semester Credits	5

Fourth Semester

BIOL 2722 Human Anatomy and Physiology 2	4
BIOL 2750 General Microbiology	4
HLTH 1570 Trained Medication Aide	2
SOCI 1710 Introduction to Sociology	4
Total Semester Credits	14

Fifth Semester

HLTH 1575 EKG & Telemetry	6
HLTH 1585 Job Readiness/Certification Exam Preparation	2
PHLB 1405 Phlebotomy	4
PHLB 1410 Phlebotomy Clinical Experience	2
Total Semester Credits	14
Total Program Credits	60

Transfer Opportunities

Saint Paul College has a transfer articulation agreement between the following program and post-secondary institutions for the baccalaureate degree programs listed below.

For more information please go to saintpaul.edu/Transfer.

Patient Care Technician AAS

BA Individualized Studies
Metropolitan State University

Practical Nursing DIPLOMA

Program Overview

Under the supervision of registered nurses and physicians, licensed practical nurses provide bedside care, monitor patients, gather information, evaluate patient needs and contribute to the patient's care. Licensed practical nurses administer medications and perform treatments. Licensed practical nurses utilize observation, critical thinking, decision-making and communication skills in caring for patients.

The Practical Nursing Diploma is designed to meet the requirements to become licensed as a Practical Nurse.

Career Opportunities

Employment of LPNs is expected to increase faster than the average for all occupations. The best opportunities will occur in nursing care facilities and home health care services. This is in response to the long-term care needs of an increasing elderly population.

Graduates may be employed in long-term care centers, clinics, home care agencies, hospice, hospitals and transitional care units. Upon completion of the program, the graduate will be prepared to take the National Council Licensure Examination for Practical Nurses (NCLEX-PN).

Licensing or certification exams are independent of graduation requirements.

Program Outcomes

1. The graduate will participate in the nursing process of assessment, planning, implementation and evaluation to provide basic safe and effective nursing care to patients.
2. The graduate will communicate effectively with patients, families, significant others and health care personnel.
3. The graduate will meet the student learning outcomes of the Nursing program.
4. The graduate will be prepared to take the NCLEX-PN licensure exam.
5. The graduate will be prepared for job placement in nursing care.

This program is accredited by the Accreditation Commission for Education in Nursing (ACEN):

3343 Peachtree Road NE
Suite 850
Atlanta, Georgia 30326
Phone: 404.975.5000
Fax: 404.975.5020
website: www.acenursing.org

*Information is subject to change.
This Program Requirements Guide is not a contract.*

Program Faculty

- Tatiana Kerestesh
tatiana.kerestesh@saintpaul.edu
- Joy Seymour
joy.seymour@saintpaul.edu
- Yewondwossen Tsegaw
yewondwossen.tsegaw@saintpaul.edu
- Biniam Weldearegay
biniam.weldearegay@saintpaul.edu

Application Process

Prior to submitting the Application to Practical Nursing Major form, an applicant must:

1. Complete the ACCUPLACER assessment and meet Minimum Program Entry Requirements (see below).
2. Complete all pre-requisites prior to PRNS courses with a cumulative GPA of 2.75 or higher and a minimum "C" grade in each course. Final acceptance/enrollment in the program is conditional upon successful completion.
3. Complete all college level courses with a GPA of 2.0 or higher.
4. Submit official transcripts from ALL colleges attended outside of Saint Paul College (if applicable).
5. Complete the Test of Essential Academic Skills (TEAS VI) with a score of 50 or higher.
6. Have obtained a Nursing Assistant certification (NAST 1111 & NAST 1112) within the last five years or have an active Minnesota Nursing Assistant Registry.
7. Submit a record of the required immunizations prior to the semester in which the student registers for clinical courses.
8. Final acceptance/enrollment in the program is conditional upon successful completion of all pre-requisites and good academic standing.
9. If accepted, attend the required Practical Nursing Seminar, which includes an overview of admissions requirements program expectations, and a schedule of classes/clinical.

The nursing admissions committee will review each application and determine admission on the basis of overall academic performance, including all previous college course work, GPA, ACCUPLACER assessment scores and Test of Essential Academic Skills (TEAS VI) scores. Notification of acceptance into the Practical Nursing major will be sent approximately 2-3 weeks after the admissions committee has met.

Required CPR course

Students are required to successfully complete a cardiopulmonary resuscitation (CPR) course prior to registering for PRNS 1481 Clinical 1.

At Saint Paul College, HLTH 1432 Basic Life Support for Healthcare Providers (BLS) 1 credit fulfills this requirement.

Fall Start

Students beginning in the Fall have the option of enrolling in day or evening PRNS theory classes. Clinical experiences are subject to clinical site availability and may be scheduled for day and/or evenings.

Spring Start

Students beginning in the Spring are scheduled for day PRNS theory classes. Clinical experiences are subject to clinical site availability and may be scheduled for day and/or evenings.

See back of this guide for Program Requirements, and Course Sequence

Minimum Program Entry Requirements

Students entering this program must meet the following minimum program entry requirements:

Reading: Score of 78+ or grade of "C" or better in READ 0722

Writing: Score of 78+ on Reading Comprehension or grade of "C" or better in ENGL 0922

Arithmetic: Score of 52+ or grade of "C" or better in MATH 0745

Assessment Results and Prerequisites: Students admitted into Saint Paul College programs may need to complete additional courses based on ACCUPLACER assessment results and course prerequisite requirements. Certain MATH, READ, and ENGL courses have additional prerequisites.

062D 621A (7023)

Practical Nursing DIPLOMA *(continued)*

Program Requirements

- All classes must be successfully completed with a grade of "C" or higher.

Preliminary courses and requirements:

The following must be completed prior to submitting your Application to Practical Nursing Major form.

- Check off when completed
- HLTH 1310 Communications in Healthcare 1
- HLTH 1410 Medical Terminology 1
- Health Core Credits 2**
- Goal 1: ENGL 1711 Composition 1 4
- Goal 3: BIOL 1730 Human Body Systems 3
- Goal 5: PSYC 1720 Psychology Throughout the Lifespan 3
- General Education Requirements 10**
- Nursing Assistant Certification (NAST 1111 & NAST 1112) completed within the last five years or active Minnesota Nursing Assistant Registry.
- TEAS Test: Complete Test of Essential Academic Skills (TEAS) with a score of 50 or higher.
- Evidence of current CPR certification (HLTH 1432) must be presented prior to taking PRNS 1481 Clinical 1.

PRNS Core Courses Cr

- PRNS 1425 Essentials of Clinical Pharmacology 2
- PRNS 1436 Foundations of Nursing 4
- PRNS 1481 Clinical 1 3
- PRNS 1482 Clinical 2 3
- PRNS 1483 Clinical 3 3
- PRNS 1521 Nursing Care of Adults 1 4
- PRNS 1524 Nursing Care of Adults 2 3
- PRNS 1531 Maternal/Child Health 2
- PRNS 2411 Psycho/Social Nursing 1
- PRNS 2492 Transition to Practice 3
- PRNS Core Credits 28**
- Health Core Credits 2**
- General Education Requirements 10**

Total Program Credits 40

Program Start Dates

Fall, Spring, or Summer - Preliminary courses only

Course Sequence

The following sequence is recommended; however, this sequence is not required.

First Semester

- HLTH 1310 Communications in Healthcare 1
- HLTH 1410 Medical Terminology 1
- Goal 1: ENGL 1711 Composition 1 4
- Goal 3: BIOL 1730 Human Body Systems 3
- Goal 5: PSYC 1720 Psychology Throughout the Lifespan 3

Pre-Nursing Credits 12

- Complete the TEAS Test, Nursing Assistant Certification requirement, and apply to the program.
- Evidence of current CPR certification (HLTH 1432) must be presented prior to taking PRNS 1481 Clinical 1.

Second Semester (Fall/Spring only)

- Practical Nursing Courses
- PRNS 1425 Essentials of Clinical Pharmacology 2
- PRNS 1436 Foundations of Nursing 4
- PRNS 1481 Clinical 1 3
- PRNS 1521 Nursing Care of Adults 1 4
- PRNS 2411 Psycho/Social Nursing 1
- PRNS Core Credits 14**

Third Semester (Fall/Spring only)

- Practical Nursing Courses
- PRNS 1482 Clinical 2 3
- PRNS 1483 Clinical 3 3
- PRNS 1524 Nursing Care of Adults 2 3
- PRNS 1531 Maternal/Child Health 2
- PRNS 2492 Transition to Practice 3
- PRNS Core Credits 14**

Total Program Credits 40

Nursing Assistant Home Health Aide CERTIFICATE

Program Overview

Nursing assistants and Home Health Aides provide direct client care under the direction of a nurse or doctor in a variety of health care settings. Using technical skills learned in both the classroom and clinical setting, nursing assistants and home health aides perform such tasks as feeding, bathing, positioning, ambulating and comfort measures for the client. Students explore and discuss legal, ethical and safety issues in client care. Students are prepared to take the National Nurse Aide Assessment Program (NNAAP) test to be placed on the Minnesota State Nursing Assistant Registry.

Qualifications include achieving appropriate assessment scores as indicated in Minimum Program Entry Requirements.

Licensing certification or registry status are independent of graduation requirements.

Career Opportunities

Graduates of the Nursing Assistant/Home Health Aide Program must successfully take and complete the nursing assistant test exam administered through the designated State testing service to be placed on the Minnesota State Nursing Assistant Registry. Nursing assistants must be on the registry to be employed in the long term care setting.

In Minnesota, employment for nursing assistants is expected to grow at an average rate. Nationally, the number of jobs is expected to grow faster than average.

Upon completion of this course, certified nursing homes or certified boarding care homes are required to reimburse for training and testing expenses paid by the student. This is to be done 90 days from the date of employment.

Note: reimbursement is not paid to third parties.

Licensing or certification exams are independent of graduation requirements.

Program Outcomes

1. Graduates will be prepared to provide direct client care in a long term care facility or home health care setting.
2. Graduates will be prepared to meet the requirements to be placed on the Minnesota State Nursing Assistant Registry.

Program Faculty

Please contact the Health Programs Administrative Assistant at 651.846.1413.

Additional Program Material Costs

Students should expect to spend approximately \$327.00 beyond the cost of tuition and fees for Minnesota registry test, books, supplies or uniforms.

Program Requirements

Check off when completed

Course	Cr
--------	----

Students must take both NAST 1111 and NAST 1112 in the same term. Classes are offered fall, spring and summer.

- NAST 1111 Nursing Assistant & Home Health Aide. 4
- NAST 1112 Nursing Assistant – Clinical. 1

Total Program Credits 5

Program Start Dates

Fall, Spring, Summer

Minimum Program Entry Requirements

Students entering this program must meet the following minimum program entry requirements:

Reading: Score of 38+ or grade of "C" or better in READ 0721

OR

ESL Reading: Score of 81 or better

Assessment Results and Prerequisites:

Students admitted into Saint Paul College programs may need to complete additional courses based on assessment results and course prerequisite requirements. Certain MATH, READ, and ENGL courses have additional prerequisites.

270C

*Information is subject to change.
This Program Requirements Guide is not a contract.*

Pharmacy Technician AAS DEGREE

Program Overview

Pharmacy technicians play an integral role in assisting pharmacists with medication dispensing. Pharmacy technicians work in hospitals, drug stores, and other medical settings. Pharmacy technicians perform a variety of duties that require strong attention to detail. Pharmacy Technicians perform duties such as, entering prescription orders into the computer, preparing medications for pharmacist verification (including measuring and sometimes mixing the medication), maintaining accurate patient records, performing calculations, and providing customer service.

This program prepares students to take the Pharmacy Technician Certification Exam.

Career Opportunities

Pharmacy technicians work in hospitals, drug stores, specialty pharmacies, and insurance company settings. Employment projections indicate an increase of 32% from 2010 to 2020, according to the U.S. Bureau of Labor Statistics.

Program Outcomes

1. Graduates will have skills to provide medications to patients including ordering stocking and packaging.
2. Graduates will understand and apply skills in institutional setting in sterile product processing.
3. Graduates will have mastered the general education requirements for work and life.
4. Graduates will be able to perform administrative duties in a variety of pharmacy related workplace settings.
5. Graduates will apply appropriate customer service skills in a hospital or retail based pharmacy.
6. Graduates will be prepared to take the Pharmacy Technician Certification Exam.
7. Graduates will demonstrate an understanding of all regulations that govern pharmacy technicians.
8. Graduates will perform duties as a pharmacy technician in retail and hospital environments.
9. Graduates will demonstrate the ability to prepare and interpret pharmacy orders accurately.
10. Graduates will exhibit work ethic characteristics of professionalism, responsibility and dependability.
11. Graduates will apply knowledge of basic sciences to the practice of pharmacy technology.
12. Graduates will demonstrate ability to communicate with patients, health care providers and colleagues.

Program Faculty

Hannah Kokesh hannah.kokesh@saintpaul.edu

Additional Program Material Costs

Students should expect to spend approximately \$750.00 beyond the cost of tuition and fees for books, supplies, uniforms, parking at internship site, and professional fees. There are additional fees for the certification exam and board of pharmacy registration (see below).

Licenses/Testing

- Certification Exam \$129.00
- Minnesota Board of Pharmacy Registration \$37.50

Application Process

After completing the Saint Paul College application and admission process, students interested in the Pharmacy Technician program must submit a completed Application to Pharmacy Technician Program form available on the Pharmacy Technician Web page: saintpaul.edu/PharmacyTech and meet the following criteria:

- Achieve a cumulative GPA of 2.8 or better
- Meet minimum program entry requirements (back page of this guide)

Admission to the Program

Applying by the priority application deadline (listed on the application) does not guarantee admission to the Pharmacy Technician Program. Being admitted to Saint Paul College does not imply admission into the Pharmacy Technician Program.

The Pharmacy Technician Program will review applications starting January 15th and accept qualified students on a first-come, first serve basis.



*Information is subject to change.
This Program Requirements Guide is not a contract.*

Program Start Dates

Fall

Course Sequence

The following course sequence is recommended for a full-time student; however, the sequence is not required. Not all courses are offered each semester; a selection of courses is offered summer term. Students should consult with Program Advisor each semester.

See back of this guide for Program Requirements, Course Sequence, and Transfer Opportunities

Minimum Program Entry Requirements

Students entering this program must meet the following minimum program entry requirements:

Reading: Score of 78+ or a grade of "C" or better in READ 0722

Writing: Score of 78+ on Reading Comprehension or a grade of "C" or better in ENGL 0922

Elementary Algebra: Score of 76+ or grade of "C" or better in MATH 0910

Assessment Results and Prerequisites: Students admitted to Saint Paul College programs may need to complete additional courses based on assessment results and course prerequisite requirements. Certain MATH, READ, and ENGL courses have additional prerequisites.

310A 6109 (7198)

Pharmacy Technician AAS DEGREE *(continued)*

Program Requirements

- All courses must be successfully completed with a grade of "C" or better.

Course	Cr
□ HLTH 1300 Behaviors for Success and Respecting Diversity	1
□ HLTH 1310 Communication in Healthcare	1
□ HLTH 1320 Safety Precautions and Awareness of Client Needs	1
□ HLTH 1410 Medical Terminology	1
□ PHAR 1710 Pharmacy Law and Ethics	3
□ PHAR 1715 Fundamentals of Pharm Tech 1	5
□ PHAR 1720 Foundations of Pharmaceutical Calculations	4
□ PHAR 1730 Principles of Pharmacy	5
□ PHAR 1735 Pharmacy Medication Tech	1
□ PHAR 1750 Pharmacy Internship 1 - Retail	3
□ PHAR 2710 Fundamentals of Pharm Tech 2	5
□ PHAR 2720 Pharmacy Sterile Products Lab	5
□ PHAR 2740 Pharmacotherapy of Disease Processes	4
□ PHAR 2750 Pharmacy Internship 2 - Hospital	4
Subtotal	43
General Education/MnTC Requirements	Cr
Refer to the Minnesota Transfer Curriculum Course List for each Goal Area	
□ Goal 1: Communication	7
ENGL 1711 Composition 1 – 4 cr	
COMM 17XX – 3 cr	
□ Goal 3: Natural Sciences	7
BIOL 1730 Human Body Systems – 3 cr	
CHEM 1711 Principles of Chemistry 1 – 4 cr	
□ Goal 6: Humanities & Fine Arts	3
PHIL 1722 Health Care Ethics – 3 cr	
General Education Requirements	17
Total Program Credits	60

Course Sequence

The following course sequence is recommended for a full-time student; however, the sequence is not required. Not all courses are offered each semester; a selection of courses is offered summer term. Students should consult with Program Advisor each semester.

All courses must be successfully completed with a grade of "C" or better. Students must meet minimum program entry requirements.

First Semester

PHAR 1710 Pharmacy Law and Ethics	
PHAR 1715 Fundamentals of Pharmacy Technology 1	5
PHAR 1720 Foundations of Pharmaceutical Calculations	4
Goal 3: BIOL 1730 Human Body Systems	3
HLTH 1410 Medical Terminology	1
Total Semester Credits	16

Second Semester

PHAR 1730 Principles of Pharmacy	5
PHAR 1735 Pharmacy Medication Technology	1
PHAR 1750 Pharmacy Internship 1 – Retail	3
PHAR 2710 Fundamentals of Pharmacy Technology 2	5
Total Semester Credits	14

Third Semester

PHAR 2720 Pharmacy Sterile Products Lab	5
PHAR 2740 Pharmacotherapy of Disease Processes	4
PHAR 2750 Pharmacy Internship 2 - Hospital	4
Goal 6: PHIL 1722 Health Care Ethics	3
Total Semester Credits	16

Fourth Semester

Goal 1: COMM 17XX	3
Goal 1: ENGL 1711 Composition 1	4
Goal 3: CHEM 1711 Principles of Chemistry 1	4
HLTH 1300 Behaviors for Success and Respecting Diversity	1
HLTH 1310 Communication in Healthcare	1
HLTH 1320 Safety Precautions and Awareness of Client Needs	1
Total Semester Credits	14

Total Program Credits 60

Recommended Supplemental Courses:

The following optional courses reinforce the basic skills required for attaining proficiency in performing pharmacy technician procedures.

PHAR 1700 Success Skills for the Pharmacy Technician 1 (First Semester)	2
PHAR 1740 Success Skills for the Pharmacy Technician 2 (Second Semester)	2
PHAR 2700 Success Skills for the Pharmacy Technician 3 (Third Semester)	1
PHAR 1800 Pharmacy Technician Certification Exam Prep (Summer)	1

Transfer Opportunities

Saint Paul College has a transfer articulation agreement between the following program and post-secondary institutions for the baccalaureate degree programs listed below.

For more information please go to saintpaul.edu/Transfer.

Pharmacy Technician AAS

BA	Health Care Administration Concordia University, St. Paul
BA	Individualized Studies Metropolitan State University
BS	Healthcare and Human Service Management Saint Mary's University, Twin Cities Campus

Pharmacy Technician DIPLOMA

Program Overview

Pharmacy technicians play an integral role in assisting pharmacists with medication dispensing. Pharmacy technicians work in hospitals, drug stores, and other medical settings. Pharmacy technicians perform a variety of duties that require strong attention to detail. Pharmacy Technicians perform duties such as, entering prescription orders into the computer, preparing medications for pharmacist verification (including measuring and sometimes mixing the medication), maintaining accurate patient records, performing calculations, and providing customer service.

This program prepares students to take the Pharmacy Technician Certification Exam.

Career Opportunities

Pharmacy technicians work in hospitals, drug stores, specialty pharmacies, and insurance company settings. Employment projections indicate an increase of 32% from 2010 to 2020, according to the U.S. Bureau of Labor Statistics.

Program Outcomes

1. Graduates will have skills to provide medications to patients including ordering stocking and packaging.
2. Graduates will understand and apply skills in institutional setting in sterile product processing.
3. Graduates will have mastered the general education requirements for work and life.
4. Graduates will be able to perform administrative duties in a variety of pharmacy related workplace settings.
5. Graduates will apply appropriate customer service skills in a hospital or retail based pharmacy.
6. Graduates will be prepared to take the Pharmacy Technician Certification Exam.
7. Graduates will demonstrate an understanding of all regulations that govern pharmacy technicians.
8. Graduates will perform duties as a pharmacy technician in retail and other practice settings.
9. Graduates will demonstrate the ability to prepare and interpret pharmacy orders accurately.
10. Graduates will exhibit work ethic characteristics of professionalism, responsibility and dependability.
11. Graduates will apply knowledge of basic sciences to the practice of pharmacy technology.
12. Graduates will demonstrate ability to communicate with patients, health care providers and colleagues.

Program Faculty

Hannah Kokesh hannah.kokesh@saintpaul.edu

Additional Program Material Costs

Students should expect to spend approximately \$450.00 beyond the cost of tuition and fees for books, supplies, uniforms and professional fees. There are additional fees for the certification exam and Board of Pharmacy Registration (see below).

Licenses/Testing

- Certification Exam \$129.00
- Minnesota Board of Pharmacy Registration \$37.50

Application Process

After completing the Saint Paul College application and admission process, students interested in the Pharmacy Technician program must submit a completed Application to Pharmacy Technician Program form available on the Pharmacy Technician Web page: saintpaul.edu/PharmacyTech and meet the following criteria:

- Achieve a cumulative GPA of 2.8 or better
- Meet minimum program entry requirements (see page 2 of this guide)

Admission to the Program

Applying by the priority application deadline (listed on the application) does not guarantee admission to the Pharmacy Technician Program. Being admitted to Saint Paul College does not imply admission into the Pharmacy Technician Program.

The Pharmacy Technician Program will review applications starting January 15th and accept qualified students on a first-come, first serve basis.



*Information is subject to change.
This Program Requirements Guide is not a contract.*

Program Requirements

- Check off when completed
- All courses must be successfully completed with a grade of "C" or better.

Course	Cr
<input type="checkbox"/> HLTH 1300 Behaviors for Success and Respecting Diversity	1
<input type="checkbox"/> HLTH 1310 Communication in Healthcare	1
<input type="checkbox"/> HLTH 1320 Safety Precautions and Awareness of Client Needs	1
<input type="checkbox"/> HLTH 1410 Medical Terminology	1
<input type="checkbox"/> PHAR 1710 Pharmacy Law and Ethics	3
<input type="checkbox"/> PHAR 1715 Fundamentals of Pharm Tech 1	5
<input type="checkbox"/> PHAR 1720 Foundations of Pharmaceutical Calculations	4
<input type="checkbox"/> PHAR 1730 Principles of Pharmacy	5
<input type="checkbox"/> PHAR 1735 Pharmacy Medication Tech	1
<input type="checkbox"/> PHAR 1750 Pharmacy Internship 1 - Retail	3
<input type="checkbox"/> PHAR 2740 Pharmacotherapy of Disease Processes	4
<input type="checkbox"/> Goal 1: COMM 17XX	3
<input type="checkbox"/> Goal 3: BIOL 1730 Human Body Systems	3

Total Program Credits 35

See back of this guide for Program Requirements, and Course Sequence

Minimum Program Entry Requirements

Students entering this program must meet the following minimum program entry requirements:

Reading: Score of 78+ or a grade of "C" or better in READ 0722

Writing: Score of 78+ on Reading Comprehension or a grade of "C" or better in ENGL 0922

Elementary Algebra: Score of 76+ or grade of "C" or better in MATH 0910

Assessment Results and Prerequisites: Students admitted to Saint Paul College programs may need to complete additional courses based on assessment results and course prerequisite requirements. Certain MATH, READ, and ENGL courses have additional prerequisites.

364D (7199)

Pharmacy Technician DIPLOMA *(continued)*

Program Start Dates

Fall

Course Sequence

The following course sequence is recommended for a full-time student; however, the sequence is not required. Not all courses are offered each semester; a selection of courses is offered summer term. Students should consult with Program Advisor each semester.

First Semester

HLTH 1410 Medical Terminology	1
PHAR 1710 Pharmacy Law and Ethics.	3
PHAR 2710 Fundamentals of Pharmacy Technology 1	5
PHAR 1720 Foundations of Pharmaceutical Calculations	4
Total Semester Credits.	13

Second Semester

PHAR 1730 Principles of Pharmacy.	5
PHAR 1735 Pharmacy Medication Technology.	1
PHAR 1750 Pharmacy Internship 1 – Retail	3
PHAR 2740 Pharmacotherapy of Disease Processes	4
Total Semester Credits.	13

Third Semester

Goal 1: COMM 17XX	3
Goal 3: BIOL 1730 Human Body Systems.	3
HLTH 1300 Behaviors for Success and Respecting Diversity.	1
HLTH 1310 Communication in Healthcare	1
HLTH 1320 Safety Precautions and Awareness of Client Needs	1
Total Semester Credits.	9

Total Program Credits 35

Recommended Supplemental Courses:

The following optional courses reinforce the basic skills required for attaining proficiency in performing pharmacy technician procedures.

PHAR 1700 Success Skills for the Pharmacy Technician 1 (First Semester)	2
PHAR 1740 Success Skills for the Pharmacy Technician 2 (Second Semester)	2
PHAR 1800 Pharmacy Technician Certification Exam Prep (Summer)	1

Public Health AS DEGREE

Program Overview

The Public Health AS degree is designed for students who plan to pursue a bachelor's degree in public health, health education, community health, epidemiology, health administration, or environmental health. The program builds upon foundational knowledge of the biological sciences and emphasizes communication, cultural competency, and the ability to interpret qualitative and quantitative research. Students admitted to the program will explore the public health system, population health challenges, biometric and social determinants of health, and public health preparedness through a variety of applied learning and community service opportunities.

Career Opportunities

Want to help change lives? Public Health professionals work in federal, state, and non-profit agencies, as well as in academic institutions, hospitals, and clinics. They influence change through education, health promotion, research, and policy. Specific job titles may include; health educator, healthcare administrator, emergency preparedness specialist, field investigator, food-safety inspector, epidemiologist, public health nurse, WIC nutrition specialist, or refugee coordinator. Employment Outlook for Health Educators in the seven county Minneapolis-Saint Paul, MN area is expected to increase by 8.8 percent between 2014-2024.

Program Outcomes

1. Identify concepts of personal and population health and disease, including evidence-based interventions that address health-related needs.
2. Discuss concepts of marketing, analysis, selection, and decision-making regarding health care, products, services, and health providers.
3. Describe key concepts of public health, including the history, core values, and practice.
4. Explain the key concepts, purpose and theories of public health education and promotion.
5. Define major components in health care management and administration, including the characteristics and organizational structure of the public health systems.
6. Discuss the historical development of environmental health, focusing on the basic relationships between the physical environment and human health.
7. Describe key concepts of global health, including demographic and epidemiological transitions, measures of health status, and the burden of disease.
8. Explain the ways in which public health core competencies are used in public health work.
9. Compare methods for assessing individual and population determinants of health, disease, and health disparities.

Minimum Program Entry Requirements

Students entering this program must meet the following minimum program entry requirements:

Reading: Score of 78+ or grade of "C" or better in READ 0722

Writing: Score of 78+ on Reading Comprehension or grade of "C" or better in ENGL 0922

College Level Mathematics: Score of 50+ or grade of "C" or better in MATH 0920

Assessment Results and Prerequisites: Students admitted into Saint Paul College programs may need to complete additional courses based on assessment results and course prerequisite requirements. Certain MATH, READ, and ENGL courses have additional prerequisites.

372S (7212)

Program Faculty

Brendan Ashby brendan.ashby@saintpaul.edu

Program Requirements

Check off when completed

Core required Courses Cr

- PUBH 1700 Personal & Community Health 3
- PUBH 1710 Consumer Health 3
- PUBH 2700 Public Health Overview. 3
- PUBH 2710 Public Health Education 3
- PUBH 2720 Global Health 3
- PUBH 2770 Public Health Practicum 2

Choose 1 course for your focus area 3

- PUBH 2730 Public Health Administration . . . 3
- PUBH 2740 Environmental Health 3
- PUBH 2750 Public Health Advocacy & Leadership in Action. 3
- Subtotal. 20**

General Education/MnTC Requirements Cr

- Refer to the Minnesota Transfer Curriculum Course List for each Goal Area
- Goal 1: Communication 12
 - ENGL 1711 Composition 1 - 4cr
 - ENGL 1712 Composition 2 - 2cr
 - COMM 1710 Fundamentals of Public Speaking - 3cr
 - COMM 1730 Intercultural Communications - 3cr
 - Goal 3 Natural Science. 16
 - BIOL 1740 General Biology 1 - 5 cr
 - BIOL 1760 Nutrition - 3 cr
 - BIOL 2721 Anatomy & Physiology 1 - 4 cr
 - BIOL 2722 Anatomy & Physiology 2 OR
 - CHEM 1711 Principles of Chemistry 1 - 4cr
 - Goal 4: Mathematical/Logical Reasoning. 4
 - MATH 1740 Introduction to Statistics
 - Goal 5: History, Social Science, and Behavioral Sciences 8
 - PSYC 1710 General Psychology - 4cr
 - SOCI 1710 Introduction to Sociology - 4cr
 - General Education Requirements 40**

Total Program Credits 60

Program Start Dates

Fall, Spring, Summer-limited course offerings

Course Sequence

The following sequence is recommended for a full-time student; however, this sequence is not required. Not all courses are offered each semester and some may be offered summer term.

See back of this guide for Course Sequence and Transfer Opportunities

Information is subject to change.
This Program Requirements Guide is not a contract.

Public Health AS DEGREE *(continued)*

Course Sequence

The following sequence is recommended for a full-time student; however, this sequence is not required. Not all courses are offered each semester and some may be offered summer term.

First Semester

BIOL 1740 General Biology 1	5
COMM 1710 Fundamentals of Public Speaking	3
ENGL 1711 Composition 1	4
PUBH 1700 Personal & Community Health (fall only)	3
Total Semester Credits	15

Second Semester

BIOL 2721 Anatomy & Physiology I	4
ENGL 1712 Composition 2	2
MATH 1740 Introduction to Statistics	4
PUBH 1710 Consumer Health (spring only)	3
PUBH 2700 Public Health Overview (spring only)	3
Total Semester Credits	16

Third Semester

BIOL 2722 Anatomy & Physiology 2 OR	
CHEM 1711 Principles of Chemistry 1	4
PSYC 1710 General Psychology	4
PUBH 2710 Public Health Education (fall only)	3
PUBH 2720 Global Health (fall only)	3
Total Semester Credits	14

Fourth Semester

BIOL 1760 Nutrition	3
COMM 1730 Intercultural Communications	3
PUBH 2XXX Focus area course	3
PUBH 2770 Public Health Practicum	2
SOCI 1710 Introduction to Sociology	4
Total Semester Credits	15

Total Program Credits60

Transfer Opportunities

Saint Paul College has a transfer articulation agreement between the following program and post-secondary institutions for the baccalaureate degree programs listed below.

For more information please go to saintpaul.edu/Transfer.

Public Health AS Degree

- BA Community Health Science
Concordia University
- BA Health Care Administration
Concordia University, St. Paul
- BA Individualized Studies
Metropolitan State University
- BAS Health Services Management
University of Minnesota,
College of Continuing
and Professional Studies
- BS Community Health
Saint Cloud State University
- BS Healthcare and Human Service
Management
Saint Mary's University,
Twin Cities Campus
- BS Public Health
Saint Mary's University,
Twin Cities Campus

Respiratory Therapist AAS DEGREE

Program Overview

Respiratory Therapists (RTs) provide care and treatment for cardiac and pulmonary issues. Practitioners perform diagnostic tests, administer medical gas therapy, access and record patient emulations and implement care for acute and chronically ill patients. They provide mechanical ventilation, therapeutic procedures, and cardiopulmonary resuscitation. Laboratory procedures include pulmonary function testing; sleep study, arterial blood gas draw and analysis, hemodynamic measurements and radiologic evaluation.

Preparation best suited for this program includes excellent reading skills, biology, chemistry and physics. Further, one should have good manual dexterity and an ability to lift fifty pounds. Upon completion of the program the student is eligible to take the National Certification exam. Certification is required at graduation for licensure.

Career Opportunities

Employment of respiratory therapists is expected to increase much faster than the average for all occupations because of substantial growth of the middle-aged and elderly population, a development that will heighten the incidence of cardiopulmonary disease. Respiratory Therapists are employed by hospitals, clinics or laboratories and home care agencies. Graduates may find employment through contacts made during the clinical training experiences and employment requests received by the instructional staff.

Licensing or certification exams are independent of graduation requirements.

Program Outcomes

1. Graduates demonstrated knowledge and skills in Respiratory Therapy clinical experiences.
2. Graduates demonstrated knowledge and skills in Respiratory Therapy clinical simulations.
3. Graduates prepared to take the National Certification Exam.
4. Graduates prepared for employment as Respiratory Therapists.
5. Graduates communicate effectively with the Health Care Team.

Program Faculty

Joseph Buhain joseph.buhain@saintpaul.edu
 Gregory Morgan gregory.morgan@saintpaul.edu
 Judy Russell judy.russell@saintpaul.edu

Full-Time Only

Students in this program must be enrolled full-time with a cohort of students. Technical courses are offered only during the day.

Textbook and Supply Costs

Students should expect to spend approximately \$2,000, beyond the cost of tuition and fees, for books, for lab coat and other supplies. Additional costs include an ACLS, PALS, BLS course.

Application Process

In addition to completing the regular Saint Paul College application and admission process, students interested in the Respiratory Therapist program must submit a completed Application to Respiratory Therapist Major form and meet the following criteria:

- Completion of the following required General Education courses:
 - BIOL 1730 Human Body Systems
 - ENGL 1711 English Composition
- Documented readiness for, or completion of, the following required General Education course:
 - CHEM 1711 Principles of Chemistry 1
 - Prerequisite for Chemistry 1 is MATH 0920 Intermediate Algebra or appropriate assessment score or CHEM 1700 Chemistry Concepts
- GPA of 3.0 or above

The Respiratory Therapist Admissions Committee will review each application on the basis of overall academic ability, GPA of college level courses, assessment scores, and meeting the above criteria. Notification of acceptance into the Respiratory Therapist Major will be sent by mail 6-weeks after the deadline date stated on the Application to Respiratory Therapist Major form.

The Application to Respiratory Therapist Major form is available online: saintpaul.edu/programs/Pages/respiratory-therapist.aspx

See back of this guide for Program Requirements, Course Sequence, and Transfer Opportunities



Saint Paul College's Respiratory Therapist Program is accredited by the Commission on Accreditation for Respiratory Care (www.coarc.com). Commission on Accreditation for Respiratory Care:

1248 Harwood Road
 Bedford, TX 76021-4244
 Phone: 817.283.2835

*Information is subject to change.
 This Program Requirements Guide is not a contract.*

Minimum Program Entry Requirements

Students entering this program must meet the following minimum program entry requirements:

Reading: Score of 78+ or grade of "C" or better in READ 0722

Writing: Score of 78+ on Reading Comprehension or grade of "C" or better in ENGL 0922

College Level Mathematics: Score of 50+ or grade of "C" or better in MATH 0920

Assessment Results and Prerequisites:

Students admitted into Saint Paul College programs may need to complete additional courses based on assessment results and course prerequisite requirements. Certain MATH, READ, and ENGL courses have additional prerequisites.

063A (623A) (7045)

Respiratory Therapist AAS DEGREE *(continued)*

Program Requirements

- Check off when completed
- All classes must be successfully completed with a grade of "C" or better.

General Education Requirements

Preliminary courses prior to application. Cr

The following (2) General Education courses must be completed prior to submitting your application form for the Respiratory Therapy Major.

- Goal 1: ENGL 1711 Composition 1 4
- Goal 3: BIOL 1730 Human Body Systems. 3
- Total Prior to Application. 7**

Preliminary courses prior to RESP courses. Cr

The following (4) General Education courses must be completed before you will be allowed to register for the first RT core course RESP1411 Respiratory Care Essentials.

- HLTH 1410 Medical Terminology 1
- COMM 17XX (Goal 1 only). 3
- Goal 3: CHEM 1711 Principles of Chemistry 1 4
- Goal 5: History, Social Sciences and Behavioral Sciences 3
- Goal 6: PHIL 1722 Health Care Ethics 3
- Total Prior to Respiratory Core 14**

General Education Subtotal. 21

- Completion or Evidence of American Heart BLS with AED(CPR) course prior to the first RC Clinical. RESP1581 Respiratory Care Clinical 1.

Respiratory Care Core Courses Cr

- RESP 1411 Respiratory Care Essentials 2
- RESP 1412 Respiratory Care Essentials Lab. 1
- RESP 1510 Cardiopulmonary Pathophysiology 1. . . 3
- RESP 1521 Respiratory Care Therapeutics. 4
- RESP 1523 Respiratory Care Therapeutics Lab . . . 2
- RESP 1540 Respiratory Care Pharm 2
- RESP 1580 Introduction to Clinical. 1
- RESP 1581 Respiratory Care Clinic 1 3
- RESP 1582 Respiratory Care Clinic 2 3
- RESP 1583 Respiratory Care Clinic 3 6
- RESP 1597 Respiratory Care Clinic 4 5
- RESP 1599 Respiratory Care Clinic 5 4
- RESP 2411 Mechanical Vent. 3
- RESP 2412 Mechanical Vent Lab 1
- RESP 2420 Cardiopulmonary Pathophysiology 2. . . 1
- RESP 2430 Neonatal/Pediatric RC 2
- RESP 2440 Mgmt of the Critical Ill. 4
- RESP 2450 Cardiopulmonary Diagnostics 1
- RESP 2452 Advanced Simulation 3
- RESP 2458 Multidisciplinary RT 1
- RESP 2470 Registry Review 3
- RESP 2510 Survey of Human Disease 2
- Respiratory Care Core Subtotal. 57**

Total Program Credits 78

Program Start Dates

Fall

Course Sequence

This course sequence is required for the remaining RESP courses. Students should consult with the Program Advisor each semester. Must complete all courses with a "C" or better to go onto next semester.

First Semester Fall

- RESP 1411 Respiratory Care Essentials 2
- RESP 1412 Respiratory Care Essentials Lab 1
- RESP 1540 Respiratory Care Pharm 2
- RESP 1580 Introduction to Clinical 1
- Total Semester Credits. 6**

Second Semester Spring

- RESP 1510 Cardiopulmonary Pathophysiology 1 3
- RESP 1521 Respiratory Care Therapeutics 4
- RESP 1523 Respiratory Care Therapeutics Lab 2
- RESP 1581 Respiratory Care Clinic 1. 3
- Total Semester Credits. 12**

Third Semester Summer

- RESP 1582 Respiratory Care Clinic 2. 3
- RESP 2411 Mechanical Vent 3
- RESP 2412 Mechanical Vent Lab 1
- RESP 2420 Cardiopulmonary Pathophysiology 2 1
- Total Semester Credits. 8**

Fourth Semester Fall

- RESP 1583 Respiratory Care Clinic 3 6
- RESP 2430 Neonatal/Pediatric RC. 2
- RESP 2440 Mgmt of the Critical Ill 4
- RESP 2510 Survey of Human Disease 2
- Total Semester Credits. 14**

Fifth Semester Spring

- RESP 1597 Respiratory Care Clinic 4. 5
- RESP 2452 Advanced Simulation 3
- RESP 2458 Multidisciplinary RT 1
- RESP 2450 Cardiopulmonary Diagnostics 1
- RESP 2470 Registry Review. 3
- Total Semester Credits. 13**

Sixth Semester Summer

- RESP 1599 Respiratory Care Clinic 5 4
- Total Semester Credits. 4**

Total Respiratory Care Core Credits. 57

Total General Education Credits
(prior to beginning the RESP major). 21

Total Program Credits 78

Transfer Opportunities

Saint Paul College has a transfer articulation agreement between the following program and post-secondary institutions for the baccalaureate degree programs listed below.

For more information please go to saintpaul.edu/Transfer.

Respiratory Therapist AAS

- BA Health Care Administration
Concordia University, St. Paul
- BA Individualized Studies
Metropolitan State University
- BAH Applied Health
University of Minnesota, Crookston
- BAS Healthcare Leadership & Administration
Winona State University
- BS Healthcare and Human Service Management
Saint Mary's University,
Twin Cities Campus
- BS Pulmonary Science
Concordia University

Surgical Technology AAS DEGREE

Program Overview

The Surgical Technologist is a critical member of the patient care team during surgery. They are responsible for a wide variety of duties, including preparing and maintaining the sterile field and all instruments and supplies used during surgery. Surgical Technologists responsibilities include anticipating the next steps during the surgical procedure and assisting if needed. The Surgical Technology AAS degree is designed to provide students with the knowledge, skills, and professionalism in order to participate safely, and effectively in the perioperative environment.

Career Opportunities

Most Surgical Technologists work in a wide variety of hospital settings; from community hospitals to trauma centers, as well as standalone day surgery outpatient facilities. Employment of Surgical Technologists is projected to grow 15 percent from 2014 to 2024, much faster than the average for all occupations. The immediate need for Surgical technologists is vast, with a multitude of opportunities for properly trained Surgical Technologists.

Program Outcomes

1. To prepare competent entry-level surgical technologists in the cognitive (knowledge), psychomotor (skills), and affective (behavior) learning domains.
2. Integrate a comprehensive understanding of medical terminology into the practice of surgical technology.
3. Apply basic understanding of anatomy, physiology, pathophysiology, pharmacology, and microbiology as it applies to surgical procedures.
4. Demonstrate consistent proficiency in the application of aseptic technique in all aspects of the surgical care of patients.
5. Demonstrate basic competence in the safe and proper use of surgical instruments, supplies, and equipment used to provide patient care in the surgical environment.
6. Communicate effectively and professionally with all members of the surgical team.
7. Work effectively and respectfully with a diverse population.

Program Faculty

Jolianne Mohler jolianne.mohler@saintpaul.edu
 Viki Viertel viki.viertel@saintpaul.edu

Program Requirements

- Check off when completed
- All SURG courses must be completed with a "C" or better.

Course	Cr
<input type="checkbox"/> BIOL 1471 Medical Terminology	2
<input type="checkbox"/> BTEC 1418 Computer Fundamentals.	3
<input type="checkbox"/> SURG 1405 Intro to Surgical Technology.	1
<input type="checkbox"/> SURG 1410 Sterile Processing	3
<input type="checkbox"/> SURG 1415 Surgical Microbiology	2
<input type="checkbox"/> SURG 2405 Pharmacology	2
<input type="checkbox"/> SURG 2410 Pathology & Procedure.	4
<input type="checkbox"/> SURG 2415 Operating Room Lab 1	4
<input type="checkbox"/> SURG 2420 Operating Room Lab 2	4
<input type="checkbox"/> SURG 2425 Operating Room Clinical 1 & 2.	16
Subtotal	41

General Education/MnTC Requirements Cr

Refer to the Minnesota Transfer Curriculum Course List for each Goal Area

<input type="checkbox"/> Goal 1: Communication	3
COMM 1710 Fundamentals of Public Speaking OR	
COMM 1720 Interpersonal Communication – 3 cr	
<input type="checkbox"/> Goal 3 Natural Sciences	13
BIOL 1740 General Biology 1.	5
BIOL 2721 Human Anatomy and Physiology 1	4
BIOL 2722 Human Anatomy and Physiology 2	4
<input type="checkbox"/> Goal 5: History, Social Science and	
Behavioral Sciences	3
PSYC 1720 Psychology Throughout the Lifespan . .	3
General Education Requirements	19

Total Program Credits60

Program Start Dates

Fall, Spring
 Day cohort classes offered as well as afternoon/evening cohorts. Day and afternoon/evening cohort start dates alternate every other semester. For more information, please consult with an academic advisor.

Prerequisites/Admission Guidelines:

1. Successful completion of the Sterile Processing Certificate with a minimum 2.75 GPA.
2. Evidence of immunization or a positive Rubella Titer. Students are strongly encouraged to take the Hepatitis B vaccine.
3. Attend required orientation session after program acceptance.
4. Complete required CPR course prior to clinical courses

Course sequence

The following course sequence is recommended. Not all courses are offered each semester; a selection of courses is offered summer term. Students should consult with an academic advisor each semester.

See back of this guide for Course Sequence and Transfer Opportunities

Minimum Program Entry Requirements

Students entering this program must meet the following minimum program entry requirements:

Reading: Score of 78+ or grade of "C" or better in READ 0722

Writing: Score of 78+ on Reading Comprehension or Grade of "C" or better in ENGL 0922

Arithmetic: Score of 52+ or grade of "C" or better in MATH 0745

Assessment Results and Prerequisites:

Students admitted into Saint Paul College programs may need to complete additional courses based on assessment results and course prerequisite requirements. Certain MATH, BIOL, and CHEM courses have additional prerequisites.

370A (7218)

*Information is subject to change.
 This Program Requirements Guide is not a contract.*

Surgical Technology AAS DEGREE *(continued)*

Course sequence

The following course sequence is recommended. Not all courses are offered each semester; a selection of courses is offered summer term. Students should consult with an academic advisor each semester.

First Semester

BIOL 1740 General Biology 1	5
PSYC 1720 Psychology Throughout the Lifespan.	3
Total Semester Credits	8

Second Semester

BIOL 1471 Medical Terminology.	2
BIOL 2721 Human Anatomy and Physiology 1	4
BTEC 1418 Computer Fundamentals	3
COMM 1710 Fundamentals of Public Speaking OR COMM 1720 Interpersonal Communication . . .	3
Total Semester Credits	12

Third Semester

BIOL 2722 Human Anatomy and Physiology 2	4
SURG 1405 Intro to Surgical Technology	1
SURG 1410 Sterile Processing	3
SURG 1415 Surgical Microbiology	2
Total Semester Credits	10

Fourth Semester

SURG 2405 Pharmacology	2
SURG 2410 Pathology & Procedure	4
SURG 2415 Operating Room Lab 1	4
SURG 2420 Operating Room Lab 2	4
Total Semester Credits	14

Fifth Semester

SURG 2425 Operating Room Clinical 1 & 2	16
Total Semester Credits	16

Total Program Credits **60**

Transfer Opportunities

Saint Paul College has a transfer articulation agreement between the following program and post-secondary institutions for the baccalaureate degree programs listed below.

For more information please go to saintpaul.edu/Transfer.

Surgical Technology AAS

BA	Individualized Studies Metropolitan State University
BS	Healthcare and Human Service Management Saint Mary's University, Twin Cities Campus

Sterile Processing CERTIFICATE

Program Overview

The Saint Paul College Sterile Processing certificate is a 30-credit program that prepares graduates to work in medical facilities that prepare surgical instruments, supplies and equipment necessary for healthcare. This program includes a broad introduction to health sciences, as well as medical terminology, communication, and computers. The program curriculum includes instruction in decontamination processes, preparation, packaging, sterilization and sterile storage of surgical instrumentation and supplies.

Students who successfully complete the certificate program are prepared for entry-level employment in a sterile processing position. Graduates are eligible to take the certification examination following 400 hours of professional employment, and are eligible to apply to the AAS Surgical Technology Program at Saint Paul College.

Career Opportunities

The work environment is dynamic and fast-paced. The work is challenging, highly technical, and complex. The performance of this vital role has a major impact on the smooth operation of the many departments to which it provides products and services. Employment opportunities may be within hospitals, outpatient centers, and instrument processing centers. Wage information is available from the Minnesota Department of Education and the Minnesota Department of Employment and Economic Development.

Program Outcomes

1. To prepare competent entry-level surgical technologists in the cognitive (knowledge), psychomotor (skills), and affective (behavior) learning domains
2. Utilize the English language effectively to read, write, speak, and listen critically
3. Enhance logical and critical thinking skills as it relates to sterile processing job duties
4. Preparation for entry level position in a sterile processing department
5. Demonstrate comprehension and identification of basic surgical instrumentation
6. Demonstrate proper usage of medical terminology as it relates to sterile processing
7. Develop and use computer skills utilized in sterile processing
8. Demonstrates an understanding of sterilization processes

Program Faculty

Jolianne Mohler jolianne.mohler@saintpaul.edu
 Viki Viertel viki.viertel@saintpaul.edu

Additional Program Materials

Students should expect to spend approximately \$135 for supplies. This cost is beyond the cost of tuition and fees and subject to change.

Program Requirements

- Check off when completed
- All SURG courses must be completed with a "C" or better.

Course	Cr
<input type="checkbox"/> BIOL 1471 Medical Terminology	2
<input type="checkbox"/> BTEC 1418 Computer Fundamentals.	3
<input type="checkbox"/> SURG 1405 Intro to Surgical Technology.	1
<input type="checkbox"/> SURG 1410 Sterile Processing	3
<input type="checkbox"/> SURG 1415 Surgical Microbiology	2
Subtotal	11

General Education/MnTC Requirements

General Education/MnTC Requirements	Cr
Refer to the Minnesota Transfer Curriculum Course List for each Goal Area	
<input type="checkbox"/> Goal 1: Communication	3
COMM 1710 Fundamentals of Public Speaking OR	
COMM 1720 Interpersonal Communication – 3 cr	
<input type="checkbox"/> Goal 3 Natural Sciences	13
BIOL 1740 General Biology 1	5
BIOL 2721 Human Anatomy and Physiology 1	4
BIOL 2722 Human Anatomy and Physiology 2 . . .	4
<input type="checkbox"/> Goal 5: History, Social Science and Behavioral Sciences	3
PSYC 1720 Psychology Throughout the Lifespan . .	3
General Education Requirements	19

Total Program Credits 30

*Successful completion of the Sterile Processing Certificate with a minimum 2.75 GPA is required for admission to the Surgical Technology AAS degree at Saint Paul College.

*Information is subject to change.
 This Program Requirements Guide is not a contract.*

Program Start Dates

Fall, Spring

Day cohort classes offered as well as afternoon/evening cohorts. Day and afternoon/evening cohort start dates alternate every other semester. For more information, please consult with an academic advisor.

Course Sequence

The following course sequence is recommended. Not all courses are offered each semester; a selection of courses is offered summer term. Students should consult with an academic advisor each semester.

First Semester

BIOL 1740 General Biology 1	5
PSYC 1720 Psychology Throughout the Lifespan. . . .	3
Total Semester Credits	8

Second Semester

BIOL 1471 Medical Terminology.	2
BIOL 2721 Human Anatomy and Physiology 1.	4
BTEC 1418 Computer Fundamentals	3
COMM 1710 Fundamentals of Public Speaking OR	
COMM 1720 Interpersonal Communication.	3
Total Semester Credits	12

Third Semester

BIOL 2722 Human Anatomy and Physiology 2.	4
SURG 1405 Intro to Surgical Technology	1
SURG 1410 Sterile Processing	3
SURG 1415 Surgical Microbiology	2
Total Semester Credits	10

Total Program Credits 30

Minimum Program Entry Requirements

Students entering this program must meet the following minimum program entry requirements:

Reading: Score of 78+ or grade of "C" or better in READ 0722

Writing: Score of 78+ on Reading Comprehension or grade of "C" or better in ENGL 0922

Arithmetic: Score of 52+ or grade of "C" or better in MATH 0745

Assessment Results and Prerequisites: Students admitted into Saint Paul College programs may need to complete additional courses based on assessment results and course prerequisite requirements. Certain MATH, READ, and ENGL courses have additional prerequisites.

370C (7220)

Clinical Sports Massage AAS DEGREE

Program Overview

The AAS in Clinical Sports Massage builds upon the existing Massage Therapy Certificate Program. Graduates perform thorough patient assessments and develop care plans based on assessments. Students implement care plans using carefully selected techniques for the given disorders, including recommended exercises to the client. Clinical Sports Massage techniques include, but are not limited to, friction therapy, trigger point therapy, active and passive engagement techniques, scraping techniques, fascial release techniques, manual lymphatic drainage and advanced stretching modalities.

Career Opportunities

Huge growth in age group sports such as triathlon, running, skiing, soccer, rugby and hockey, have led to more people returning to a sporting lifestyle than ever before. The direct correlation is an increase in injuries and/or need for prevention of injury. With increased proven results utilizing various soft tissue manual therapies, more people are relying on well trained Clinical Sports Massage Therapists to alleviate and/or prevent injury. There is a large demand for Clinical Sports Massage Therapists in rehabilitation facilities, sports chiropractic offices, onsite sports events, health clubs, and with self-employment. The Clinical Sports Massage Advanced Certificate qualifies graduates to apply for board certification. All classes within this curriculum qualify as continuing education for massage therapy.

Program Outcomes

1. Graduates will provide application of manual techniques to positively contribute to the well-being of the client in a safe and skillful manner.
2. Graduates will be prepared to take the national certification exam in massage therapy.
3. Graduates will be prepared for employment in an entry-level capacity.
4. Graduates will be prepared to take the Board Certification through the National Certification Board for Therapeutic Massage & Bodywork (NCTMB).
5. Graduates will be prepared for employment in a sports and rehabilitation environment.

Program Faculty

Nick Bohrer nick.bohrer@saintpaul.edu
 Jeremy Sartain jeremy.sartain@saintpaul.edu

Day and Evening Classes

Classes may be offered day and evening.

Textbook and Supply Costs

Students should expect to spend approximately \$1,900.00 for books and supplies. (Does not include massage table.) This cost is in addition to tuition and fees.

Program Requirements

- Check off when completed
- All technical courses (HLTH, MASS) must be successfully completed with a grade of "C" or better.

Course	Cr
<input type="checkbox"/> HLTH 1418 Somatic Practitioner: Business & Ethics	2
<input type="checkbox"/> HLTH 1421 Anatomy & Physiology for Somatic Practitioners	4
<input type="checkbox"/> HLTH 1422 Health and Wellness Coaching	4
<input type="checkbox"/> HLTH 1425 Clinical Applications in Kinesiology	3
<input type="checkbox"/> HLTH 1465 Functional Holistic Nutrition	4
<input type="checkbox"/> HLTH 1485 Therapeutic Exercise	5
<input type="checkbox"/> HLTH 1900 Pathology for the Somatic Practitioner	4
<input type="checkbox"/> MASS 1400 Introduction to Therapeutic Massage	4
<input type="checkbox"/> MASS 1421 Massage Spa Techniques	2
<input type="checkbox"/> MASS 1422 Massage Clinical Techniques	4
<input type="checkbox"/> A CPR course/certificate must be completed prior to taking MASS 1480 Massage Therapy Practicum	
<input type="checkbox"/> MASS 1423 Advanced Clinical Sports Massage Techniques	5
<input type="checkbox"/> MASS 1480 Massage Therapy Practicum	4
<input type="checkbox"/> MASS 1490 Clinical Massage Internship	5
Subtotal	50

General Education/MnTC Requirements Cr

Refer to the Minnesota Transfer Curriculum Course List for each Goal Area

<input type="checkbox"/> Goal 1: Communication	7
ENGL 1711 Composition 1 – 4 cr COMM 17XX – 3 cr	
<input type="checkbox"/> Goal 3: Natural Sciences	3
BIOL 1760 Nutrition – 3 cr (recommended)	
<input type="checkbox"/> Goal 5: History, Social Science and Behavioral Sciences	3
PSYC 1750 Introduction to Health Psychology – 3 cr (recommended)	
<input type="checkbox"/> Goal 6: Humanities and Fine Arts	3
General Education Requirements	16

Total Program Credits 66

*Information is subject to change.
 This Program Requirements Guide is not a contract.*

Program Start Dates

Fall, Spring, Summer

Course Sequence

For part-time or customized course sequence contact Jeremy Sartain at 651.846.1619 or email jeremy.sartain@saintpaul.edu. Not all courses are offered each semester; a selection of courses is offered summer term. Students should consult with the Program Faculty each semester.

See back of this guide for Course Sequence and Transfer Opportunities

Minimum Program Entry Requirements

Students entering this program must meet the following minimum program entry requirements:

Reading: Score of 78+ or grade of "C" or better in READ 0722

Writing: Score of 78+ or grade of "C" or better in ENGL 0922

Arithmetic: Score of 20+

Assessment Results and Prerequisites:

Students admitted into Saint Paul College programs may need to complete additional courses based on assessment results and course prerequisite requirements. Certain MATH, READ, and ENGL courses have additional prerequisites.

316A (7088)

Clinical Sports Massage AAS DEGREE *(continued)*

Course Sequence

For part-time or customized course sequence contact Jeremy Sartain at 651.846.1619 or email jeremy.sartain@saintpaul.edu. Not all courses are offered each semester; a selection of courses is offered summer term. Students should consult with the Program Faculty each semester.

First Semester

HLTH 1418 Somatic Practitioner: Business & Ethics	2
HLTH 1421 Anatomy and Physiology for Somatic Practitioners	4
MASS 1400 Introduction to Therapeutic Massage	4
MASS 1421 Massage Spa Techniques	2
MASS 1422 Massage Clinical Techniques	4
Total Semester Credits	16

Second Semester

HLTH 1425 Clinical Applications in Kinesiology	3
HLTH 1465 Functional Holistic Nutrition	4
A CPR course/certificate must be completed prior to taking MASS 1480 Massage Therapy Practicum	
MASS 1480 Massage Therapy Practicum	4
Goal 5: PSYC 1750 Introduction to Health Psychology (recommended)	3
Total Semester Credits	14

Third Semester

MASS 1423 Advanced Clinical Sports Massage (fall only)	5
HLTH 1422 Health and Wellness Coaching	4
HLTH 1485 Therapeutic Exercise	5
HLTH 1900 Pathology for the Somatic Practitioner	4
Total Semester Credits	18

Fourth Semester

MASS 1490 Clinical Massage Internship	5
Goal 1: ENGL 1711 Composition 1	4
Goal 1: COMM 17XX	3
Goal 3: BIOL 1760 Nutrition (recommended)	3
Goal 6: Humanities and Fine Arts	3
Total Semester Credits	18

Total Program Credits	66
--	-----------

Transfer Opportunities

Saint Paul College has a transfer articulation agreement between the following program and post-secondary institutions for the baccalaureate degree programs listed below. For more information please go to saintpaul.edu/Transfer.

Clinical Sports Massage AAS

BA	Exercise Science (Traditional & Cohort Concordia University, St. Paul
BA	Health Care Administration Concordia University, St. Paul
BA	Individualized Studies Metropolitan State University
BA	Kinesiology Concordia University
BAS	Healthcare Leadership & Administration Winona State University
BS	Healthcare and Human Service Management Saint Mary's University, Twin Cities Campus

Clinical Sports Massage CERTIFICATE

Program Overview

Designed for Massage Therapists who have graduated from a 600 hour or more program, the Clinical Sports Massage Advanced Certificate builds on basic foundational massage therapy skills. Graduates of the Clinical Sports Massage Advanced Certificate perform thorough patient assessments and develop care plans based on assessments. Students implement care plans utilizing carefully selected techniques for the given disorders, including recommended exercises for the client. Clinical Sports Massage techniques include, but are not limited to, friction therapy, trigger point therapy, active and passive engagement techniques, scraping technique, cupping with drag, fascial release techniques, manual lymphatic drainage and advanced stretching modalities.

Career Opportunities

Huge growth in age group sports such as triathlon, running, skiing, soccer, rugby and hockey, have lead to more people returning to a sporting lifestyle than ever before. The direct correlation is an increase in injuries and/or need for prevention of injury. With increased proven results utilizing various soft tissue manual therapies, more people are relying on well trained Clinical Sports Massage Therapists to alleviate and/or prevent injury. There is a large demand for Clinical Sports Massage Therapists in rehabilitation facilities, sports chiropractic offices, onsite sports events, health clubs, and with self-employment. The Clinical Sports Massage Certificate qualifies graduates to apply for the National Certification for Advanced Practice (NCAP) exam. All classes within this curriculum qualify as continuing education for massage therapy.

Program Outcomes

1. Graduates will provide application of manual techniques to positively contribute to the well-being of the client in a safe and skillful manner.
2. Graduates will be prepared to take the national certification exam in massage therapy.
3. Graduates will be prepared for employment in an entry-level capacity.
4. Graduates will be prepared to take the Board Certification through the National Certification Board for Therapeutic Massage & Bodywork (NCTMB).
5. Graduates will be prepared for employment in a sports and rehabilitation environment.

Program Faculty

Nick Bohrer nick.bohrer@saintpaul.edu
 Jeremy Sartain jeremy.sartain@saintpaul.edu

Day Classes Only

Currently offered as day classes only. Web enhanced does limit seat time.

Textbook and Supply Costs

Students should expect to spend approximately \$1300.00 for books and supplies. (Does not include massage table) This cost is in addition to tuition and fees.

Program Requirements

- Check off when completed
- All technical courses (HLTH, MASS) must be successfully completed with a grade of "C" or better.

Course	Cr
<input type="checkbox"/> HLTH 1422 Health and Wellness Coaching	4
<input type="checkbox"/> HLTH 1485 Therapeutic Exercise	5
<input type="checkbox"/> HLTH 1900 Pathology for the Somatic Practitioner	4
<input type="checkbox"/> MASS 1423 Advanced Clinical Sports Massage Techniques.	5
<input type="checkbox"/> MASS 1490 Internship	5
Total Program Credits	23

Program Start Dates

Fall, Spring, Summer

Course Sequence

For part-time or customized course sequence contact Jeremy Sartain at 651.846.1619 or email jeremy.sartain@saintpaul.edu. Not all courses are offered each semester; a selection of courses is offered summer term. Students should consult with the Program Faculty each semester.

First Semester

HLTH 1485 Therapeutic Exercise	5
HLTH 1900 Pathology for the Somatic Practitioner	4
MASS 1423 Advanced Clinical Sports Massage (fall only)	5
Total Semester Credits.	14

Second Semester

HLTH 1422 Health and Wellness Coaching.	4
MASS 1490 Internship.	5
Total Semester Credits.	9

Total Program Credits 23

Minimum Program Entry Requirements

Completion of a minimum 600 hour massage therapy program that is recognized by the National Certification Board for Therapeutic Massage and Bodywork (NCTMB). Faculty instructor permission required. Contact Jeremy Sartain at 651.846.1619 or email jeremy.sartain@saintpaul.edu. Note that admitted students do not need to be nationally certified but the program previously completed must qualify for national certification.

Degree option may have a greater requirement than this certificate.

319C (7168)

*Information is subject to change.
 This Program Requirements Guide is not a contract.*

Massage Therapy CERTIFICATE

Program Overview

The Massage Therapy Certificate program exceeds the minimum requirement of 600 technical hours of study required for accreditation by the American Massage Therapy Association Commission on Massage Therapy Accreditation and 600 hours of study for state licensure required in surrounding states.

Massage Therapists manipulate soft tissue structures of the body to prevent and alleviate pain, using techniques such as Swedish Massage, Reflexology, Sports Massage, Neuromuscular Therapy, Myofascial Release, Lymphatic Drainage, Proprioceptive Neuromuscular Facilitation (PNF) and Active Isolated Stretching (AIS) techniques, and Travel Trigger Point Therapy. Graduates of the certificate program integrate manual massage techniques to positively contribute to the well-being of the client in a safe and skillful manner.

Career Opportunities

The employment outlook for massage therapists is projected to be better than average in the upcoming years. The increasing population, increasing personal incomes, longer life spans, and an increasing recognition that massage is beneficial to reduce stress, relieve pain, and improve overall health all contribute to an increased demand for these workers. Factors affecting long term growth include economic well-being and the degree to which insurance companies and HMOs will reimburse for this service. Graduates perform massage therapy in health spas, resorts, health clubs, retirement residences, country clubs, hospitals, chiropractic offices, long-term care facilities, and clinics, or may be self-employed.

Licensing or certification exams are independent of graduation requirements.

Program Outcomes

1. Graduates will provide application of manual techniques to positively contribute to the well-being of the client in a safe and skillful manner.
2. Graduates will be prepared to take the national certification exam in massage therapy.
3. Graduates will be prepared for employment in an entry-level capacity.

Transfer Opportunities

Saint Paul College has a transfer articulation agreement between the following program and post-secondary institution for the baccalaureate degree program listed below.

For more information please go to saintpaul.edu/Transfer.

Massage Therapy Certificate

BA Kinesiology
Concordia University

Program Faculty

Nick Bohrer nick.bohrer@saintpaul.edu
Jeremy Sartain jeremy.sartain@saintpaul.edu

Day and Evening Classes

Day and evening options are available to complete the program.

Textbook and Supply Costs

Students should expect to spend approximately \$900.00 for books and supplies. (Does not include massage table.) This cost is in addition to tuition and fees.

Program Requirements

- Check off when completed
- All technical courses (HLTH, MASS) must be successfully completed with a grade of "C" or better.

Course	Cr
<input type="checkbox"/> HLTH 1418 Somatic Practitioner: Business & Ethics	2
<input type="checkbox"/> HLTH 1421 Anatomy and Physiology for Somatic Practitioners	4
<input type="checkbox"/> HLTH 1425 Clinical Applications in Kinesiology	3
<input type="checkbox"/> HLTH 1465 Functional Holistic Nutrition	4
<input type="checkbox"/> MASS 1400 Introduction to Therapeutic Massage	4
<input type="checkbox"/> MASS 1421 Massage Spa Techniques	2
<input type="checkbox"/> MASS 1422 Massage Clinical Techniques	4
<input type="checkbox"/> A CPR course/certificate must be completed prior to taking MASS 1480 Massage Therapy Practicum	
<input type="checkbox"/> MASS 1480 Massage Therapy Practicum	4
Subtotal	27

<input type="checkbox"/> General Education Requirement	3
Goals 1-10: Minnesota Transfer Curriculum	
PSYC 1750 Introduction to Health Psychology (recommended)	

Total Program Credits 30

Program Start Dates

Fall, Spring, Summer

Course Sequence

For part-time or customized course sequence contact Jeremy Sartain at 651.846.1619 or email jeremy.sartain@saintpaul.edu. Not all courses are offered each semester; a selection of courses is offered summer term. Students should consult with the Program Faculty each semester.

First Semester

HLTH 1418 Somatic Practitioner: Business & Ethics	2
HLTH 1421 Anatomy and Physiology for Somatic Practitioners	4
MASS 1400 Introduction to Therapeutic Massage	4
MASS 1421 Massage Spa Techniques	2
MASS 1422 Massage Clinical Techniques	4
Total Semester Credits	16

Second Semester

HLTH 1425 Clinical Applications in Kinesiology	3
HLTH 1465 Functional Holistic Nutrition	4
A CPR course/certificate must be completed prior to taking MASS 1480 Massage Therapy Practicum	
MASS 1480 Massage Therapy Practicum	4
Goal 5: PSYC 1750 Introduction to Health Psychology (recommended)	3
Total Semester Credits	14

Total Program Credits 30

Minimum Program Entry Requirements

Students entering this program must meet the following minimum program entry requirements:

Reading: Score of 78+ or grade of "C" or better in READ 0722

Arithmetic: Score of 20+

Assessment Results and Prerequisites: Students admitted into Saint Paul College programs may need to complete additional courses based on assessment results and course prerequisite requirements. Certain MATH, READ, and ENGL courses have additional prerequisites.

Degree option may have a greater requirement than this certificate.

197C (7085)

*Information is subject to change.
This Program Requirements Guide is not a contract.*

Sport and Exercise Sciences AAS DEGREE

Program Overview

Sport and Exercise Sciences Professionals instruct clientele in the betterment of their health through an integrated approach using sound knowledge of appropriate sciences. Functional training techniques, aerobic exercise and advanced stretching modalities (such as Proprioceptive Neuromuscular Facilitation (PNF) and Active Isolated Stretching (AIS)) are implemented appropriately based on initial and continuous feedback and testing. Graduates from the program perform patient assessments and build customized fitness, wellness and nutrition plans for individuals.

Career Opportunities

The US Bureau of Labor and Statistics listed Sport, Exercise and Fitness as one of the top overall job openings requiring Post-Secondary training. Employment is expected to grow by 21 percent from 2014-2024 much faster than average for all occupations. As businesses and insurance organizations continue to recognize the benefits of health and fitness programs for their employees, corporate wellness program employment will continue to rise increasing the need for workers in these areas.

Program Outcomes

1. Graduates will provide application of Fitness Coaching techniques to positively contribute to the well-being of the client in a safe and skillful manner.
2. Graduates will be prepared to take a national exam for Certification in Personal Training/ Fitness Coaching.
3. Graduates will be prepared to take the National Academy of Sports Medicine (NASM) exam for Corrective Exercise Specialist (CES).
4. Graduates may obtain membership with the National Association of Nutrition Professionals (NANP).
5. Graduates will be prepared to perform Health & Wellness Coaching Services.
6. Graduates will be prepared to take the American Council on Exercise (ACE) exam for Health Coach Certification.

Licensing or certification exams are independent of graduation requirements.

Program Faculty

Jeremy Sartain jeremy.sartain@saintpaul.edu

Day and Evening Classes

Classes may be offered day and evening.

Textbook and Supply Costs

Students should expect to spend approximately \$1,300.00 for books and supplies. This cost is in addition to tuition and fees.

Program Requirements

- Check off when completed
- All technical courses (HLTH) must be successfully completed with a grade of "C" or better.

Course	Cr
<input type="checkbox"/> HLTH 1418 Somatic Practitioner: Business & Ethics	2
<input type="checkbox"/> HLTH 1421 Anatomy & Physiology for the Somatic Practitioner	4
<input type="checkbox"/> HLTH 1422 Health and Wellness Coaching	4
<input type="checkbox"/> HLTH 1425 Clinical Applications in Kinesiology	3
<input type="checkbox"/> HLTH 1465 Functional Holistic Nutrition	4
<input type="checkbox"/> HLTH 1485 Therapeutic Exercise	5
<input type="checkbox"/> HLTH 1610 Sport and Exercise Coaching.	5
<input type="checkbox"/> HLTH 1620 Advanced Concepts in Training.	5
<input type="checkbox"/> HLTH 1630 Functional Exercise Physiology	3
<input type="checkbox"/> HLTH 1690 Sport and exercise Sciences Internship	5
<input type="checkbox"/> HLTH 1900 Pathology for the Somatic Practitioner	4
Subtotal.	44

General Education/MnTC Requirements Cr

Refer to the Minnesota Transfer Curriculum Course List for each Goal Area

<input type="checkbox"/> Goal 1: Communication	7
ENGL 1711 Composition 1 – 4 cr	
COMM 17XX – 3 cr	
<input type="checkbox"/> Goal 3: Natural Sciences	3
BIOL 1760 Nutrition - 3 cr (recommended)	
<input type="checkbox"/> Goal 5: History, Social Science and Behavioral Sciences	3
PSYC 1750 Introduction to Health Psychology – 3 cr (recommended)	
<input type="checkbox"/> Goal 6: Humanities and Fine Arts.	3
General Education Requirements	16

Total Program Credits 60

Program Start Dates

Fall, Spring, Summer

Course Sequence

For part-time or customized course sequence contact Jeremy Sartain at 651.846.1619 or email jeremy.sartain@saintpaul.edu. Not all courses are offered each semester; a selection of courses is offered summer term. Students should consult with the Program Faculty each semester.

See back of this guide for Course Sequence and Transfer Opportunities

Minimum Program Entry Requirements

Students entering this program must meet the following minimum program entry requirements:

Reading: Score of 78+ or grade of "C" or better in READ 0722

Writing: Score of 78+ or grade of "C" or better in ENGL 0922

Arithmetic: Score of 20+

Assessment Results and Prerequisites: Students admitted into Saint Paul College programs may need to complete additional courses based on assessment results and course prerequisite requirements. Certain MATH, READ, and ENGL courses have additional prerequisites.

388A (7221)

*Information is subject to change.
This Program Requirements Guide is not a contract.*

Sport and Exercise Sciences AAS DEGREE *(continued)*

Course Sequence

For part-time or customized course sequence contact Jeremy Sartain at 651.846.1619 or email jeremy.sartain@saintpaul.edu. Not all courses are offered each semester; a selection of courses is offered summer term. Students should consult with the Program Faculty each semester.

First Semester

HLTH 1418 Somatic Practitioner: Business & Ethics	2
HLTH 1421 Anatomy & Physiology for the Somatic Practitioner	4
HLTH 1422 Health and Wellness Coaching.	4
HLTH 1610 Sport and Exercise Coaching	5
Total Semester Credits.	15

Second Semester

HLTH 1425 Clinical Applications in Kinesiology	3
HLTH 1485 Therapeutic Exercise	5
HLTH 1620 Advanced Concepts in Training	5
Total Semester Credits.	13

Third Semester

HLTH 1465 Functional Holistic Nutrition.	4
HLTH 1630 Functional Exercise Physiology.	3
HLTH 1690 Sport and Exercise Sciences Internship	5
HLTH 1900 Pathology for the Somatic Practitioner	4
Goal 5: PSYC 1750 Introduction to Health Psychology (recommended).	3
Total Semester Credits.	19

Fourth Semester

Goal 1: ENGL 1711 Composition 1.	4
Goal 1: COMM 17XX	3
Goal 3: BIOL 1760 Nutrition (recommended).	3
Goal 6: Humanities and Fine Arts.	3
Total Semester Credits.	13

Total Program Credits60

Transfer Opportunities

Saint Paul College has a transfer articulation agreement between the following program and post-secondary institutions for the baccalaureate degree programs listed below. For more information please go to saintpaul.edu/Transfer.

Sport and Exercise Sciences AAS

BA	Exercise Science Concordia University, St. Paul
BA	Health Care Administration Concordia University, St. Paul
BA	Individualized Studies Metropolitan State University
BA	Kinesiology Concordia University
BAS	Healthcare Leadership & Administration Winona State University
BS	Exercise Science Concordia University, St. Paul
BS	Healthcare and Human Service Management Saint Mary's University, Twin Cities Campus

Sport and Exercise Sciences DIPLOMA

Program Overview

Sport and Exercise Sciences Professionals instruct clientele in the betterment of their health through an integrated approach using sound knowledge of appropriate sciences. Functional training techniques, aerobic exercise and advanced stretching modalities (such as Proprioceptive Neuromuscular Facilitation (PNF) and Active Isolated Stretching (AIS)) are implemented appropriately based on initial and continuous feedback and testing. Graduates from the program perform patient assessments and build customized fitness, wellness and nutrition plans for individuals.

Career Opportunities

The US Bureau of Labor and Statistics listed Sport, Exercise and Fitness as one of the top overall job openings requiring Post-Secondary training. Employment is expected to grow by 21 percent from 2014-2024 much faster than average for all occupations. As businesses and insurance organizations continue to recognize the benefits of health and fitness programs for their employees, corporate wellness program employment will continue to rise increasing the need for workers in these areas.

Program Outcomes

1. Graduates will provide application of Fitness Coaching techniques to positively contribute to the well-being of the client in a safe and skillful manner.
2. Graduates will be prepared to take a national exam for Certification in Personal Training/ Fitness Coaching.
3. Graduates will be prepared to take the National Academy of Sports Medicine (NASM) exam for Corrective Exercise Specialist (CES).
4. Graduates may obtain membership with the National Association of Nutrition Professionals (NANP).
5. Graduates will be prepared to perform Health & Wellness Coaching Services.
6. Graduates will be prepared to take the American Council on Exercise (ACE) exam for Health Coach Certification.

Licensing or certification exams are independent of graduation requirements.

Transfer Opportunities

Saint Paul College has a transfer articulation agreement between the following program and post-secondary institution for the baccalaureate degree program listed below.

For more information please go to saintpaul.edu/Transfer.

Sport and Exercise Sciences Diploma

BA Kinesiology
Concordia University

Program Faculty

Jeremy Sartain jeremy.sartain@saintpaul.edu

Day and Evening Classes

Classes may be offered day and evening.

Textbook and Supply Costs

Students should expect to spend approximately \$1,000.00 for books and supplies. This cost is in addition to tuition and fees.

Program Requirements

- Check off when completed
- All technical courses (HLTH) must be successfully completed with a grade of "C" or better.

Course	Cr
<input type="checkbox"/> HLTH 1418 Somatic Practitioner: Business & Ethics	2
<input type="checkbox"/> HLTH 1421 Anatomy & Physiology for the Somatic Practitioner	4
<input type="checkbox"/> HLTH 1422 Health and Wellness Coaching	4
<input type="checkbox"/> HLTH 1425 Clinical Applications in Kinesiology	3
<input type="checkbox"/> HLTH 1465 Functional Holistic Nutrition	4
<input type="checkbox"/> HLTH 1485 Therapeutic Exercise	5
<input type="checkbox"/> HLTH 1610 Sport and exercise Coaching	5
<input type="checkbox"/> HLTH 1620 Advanced Concepts in Training	5
<input type="checkbox"/> HLTH 1630 Functional Exercise Physiology	3
<input type="checkbox"/> HLTH 1690 Sport and exercise Sciences Internship	5
<input type="checkbox"/> HLTH 1900 Pathology for the Somatic Practitioner	4
Subtotal	44

General Education/MnTC Requirements Cr

<input type="checkbox"/> Goal 1: COMM 17XX	3
<input type="checkbox"/> Goals 1-10: Minnesota Transfer Curriculum PSYC 1750 Introduction to Health Psychology (recommended)	3
General Education Requirements	6

Total Program Credits 50

*Information is subject to change.
This Program Requirements Guide is not a contract.*

Program Start Dates

Fall, Spring, Summer

Course Sequence

For part-time or customized course sequence contact Jeremy Sartain at 651.846.1619 or email jeremy.sartain@saintpaul.edu. Not all courses are offered each semester; a selection of courses is offered summer term. Students should consult with the Program Faculty each semester.

First Semester

HLTH 1418 Somatic Practitioner: Business & Ethics	2
HLTH 1421 Anatomy & Physiology for the Somatic Practitioner	4
HLTH 1422 Health and Wellness Coaching	4
HLTH 1610 Sport and Exercise Coaching	5
Total Semester Credits	15

Second Semester

HLTH 1425 Clinical Applications in Kinesiology	3
HLTH 1485 Therapeutic Exercise	5
HLTH 1620 Advanced Concepts in Training	5
Goal 1: COMM 17XX	3
Total Semester Credits	16

Third Semester

HLTH 1465 Functional Holistic Nutrition	4
HLTH 1630 Functional Exercise Physiology	3
HLTH 1690 Sport and Exercise Sciences Internship	5
HLTH 1900 Pathology for the Somatic Practitioner	4
Goal 5: PSYC 1750 Introduction to Health Psychology (recommended)	3
Total Semester Credits	19

Total Program Credits 50

Minimum Program Entry Requirements

Students entering this program must meet the following minimum program entry requirements:

Reading: Score of 78+ or grade of "C" or better in READ 0722

Arithmetic: Score of 20+

Assessment Results and Prerequisites: Students admitted into Saint Paul College programs may need to complete additional courses based on assessment results and course prerequisite requirements. Certain MATH, READ, and ENGL courses have additional prerequisites.

Degree option may have a greater requirement than this diploma.

388D (7222)

Sport and Exercise Sciences CERTIFICATE

Program Overview

Sport and Exercise Sciences Professionals instruct clientele in the betterment of their health through an integrated approach using sound knowledge of appropriate sciences. Functional training techniques, aerobic exercise and advanced stretching modalities (such as Proprioceptive Neuromuscular Facilitation (PNF) and Active Isolated Stretching (AIS)) are implemented appropriately based on initial and continuous feedback and testing. Graduates from the program perform patient assessments and build customized fitness, wellness and nutrition plans for individuals.

Career Opportunities

The US Bureau of Labor and Statistics listed Sport, Exercise and Fitness as one of the top overall job openings requiring Post-Secondary training. Employment is expected to grow by 21 percent from 2014-2024 much faster than average for all occupations. As businesses and insurance organizations continue to recognize the benefits of health and fitness programs for their employees, corporate wellness program employment will continue to rise increasing the need for workers in these areas.

Program Outcomes

1. Graduates will provide application of Fitness Coaching techniques to positively contribute to the well-being of the client in a safe and skillful manner.
2. Graduates will be prepared to take a national exam for Certification in Personal Training/ Fitness Coaching.
3. Graduates will be prepared to take the National Academy of Sports Medicine (NASM) exam for Corrective Exercise Specialist (CES).

Licensing or certification exams are independent of graduation requirements.

Program Faculty

Jeremy Sartain jeremy.sartain@saintpaul.edu

Day and Evening Classes

Classes may be offered day and evening.

Textbook and Supply Costs

Students should expect to spend approximately \$1,000.00 for books and supplies. This cost is in addition to tuition and fees.

Program Requirements

- Check off when completed
- All technical courses (HLTH) must be successfully completed with a grade of "C" or better.

Course	Cr	
<input type="checkbox"/> HLTH 1418 Somatic Practitioner:		
Business and Ethics	2	
<input type="checkbox"/> HLTH 1421 Anatomy and Physiology for the		
Somatic Practitioner	4	
<input type="checkbox"/> HLTH 1422 Health and Wellness Coaching		4
<input type="checkbox"/> HLTH 1425 Clinical Applications in Kinesiology		3
<input type="checkbox"/> HLTH 1465 Functional Holistic Nutrition		4
<input type="checkbox"/> HLTH 1485 Therapeutic Exercise		5
<input type="checkbox"/> HLTH 1610 Sport and Exercise Coaching.		5
Subtotal	27	

General Education/MnTC Requirements	Cr
<input type="checkbox"/> Goals 1-10: Minnesota Transfer Curriculum	
PSYC 1750 Introduction to Health Psychology (recommended)	3
General Education Requirements	3

Total Program Credits 30

Program Start Dates

Fall, Spring, Summer

Course Sequence

For part-time or customized course sequence contact Jeremy Sartain at 651.846.1619 or email jeremy.sartain@saintpaul.edu. Not all courses are offered each semester; a selection of courses is offered summer term. Students should consult with the Program Faculty each semester.

First Semester

HLTH 1418 Somatic Practitioner:	
Business & Ethics	2
HLTH 1421 Anatomy & Physiology for the	
Somatic Practitioner	4
HLTH 1422 Health and Wellness Coaching.	4
HLTH 1610 Sport and Exercise Coaching	5
Total Semester Credits	15

Second Semester

HLTH 1425 Clinical Applications in Kinesiology	3
HLTH 1465 Functional Holistic Nutrition.	4
HLTH 1485 Therapeutic Exercise	5
Goal 5: PSYC 1750 Introduction to Health Psychology (recommended).	3
Total Semester Credits	15

Total Program Credits 30

Minimum Program Entry Requirements

Students entering this program must meet the following minimum program entry requirements:

Reading: Score of 78+ or grade of "C" or better in READ 0722

Arithmetic: Score of 20+

Assessment Results and Prerequisites: Students admitted into Saint Paul College programs may need to complete additional courses based on assessment results and course prerequisite requirements. Certain MATH, READ, and ENGL courses have additional prerequisites.

Degree option may have a greater requirement than this certificate.

388C (7223)

*Information is subject to change.
This Program Requirements Guide is not a contract.*

Registered Yoga Teacher CERTIFICATE

Program Overview

Yoga is recognized by health professionals worldwide as an effective way to increase flexibility, develop strength and reduce stress. This program focuses on four key aspects of yoga: alignment and form of the yoga postures, history and philosophy of yoga, relaxation and meditation, and teaching techniques. This program is recognized by the Yoga Alliance and upon completion qualifies graduates to be 200 hour Registered Yoga Teachers.

Career Opportunities

Yoga instructors are listed under the main category of fitness workers with the Department of Labor. Training for yoga instructors is ever changing. According to the U.S. Department of Labor Statistics, demand for teachers of yoga has grown faster than the ability to train them properly as the interest in yoga exercise has exploded in recent years. Saint Paul College's program is designed to meet the Yoga Alliance 200 hour standards.

As health clubs strive to provide more personalized service to keep their members motivated, they continue to offer a wide variety of group exercise classes. The aging population, in particular, demand low-impact forms of exercise which yoga provides.

Yoga instructors work in: HMOs in the areas of heart health and pregnancy, wellness centers, studios with massage therapists, fitness centers, educational institutions, conference centers, chiropractic offices, spas, community education, yoga studios and cruise ships.

Program Outcomes

1. Graduates will demonstrate a clear understanding of alignment within the standing poses, seated poses, inversions, backbends, forward bends, twists and arm-balances covered in this class.
2. Graduates will demonstrate coordination of breath and movement and the correct use of the diaphragm in yogic breathing.
3. Graduates will demonstrate an understanding of the scientific evidence behind the effects of stress and relaxation.
4. Graduates will identify the mental, emotional, and physical benefits of a consistent mindfulness/meditation practice.
5. Graduates will demonstrate the ability to plan a sequence of postures to lengthen the spine and open the major joints of the body to support relaxation and healing.
6. Graduates will meet the Yoga Alliance Standards of Yoga Teacher Training.

Program Faculty

Jeremy Sartain jeremy.sartain@saintpaul.edu

Equipment Needed

Students should expect to bring to class a yoga mat and blanket, yoga strap and blocks if necessary. The blanket is used to sit on and should be a woven serape or a wool yoga blanket.

Program Length

Full-time students can complete the program in one semester.

Part-time Options

For part-time options, discuss with program faculty.

Program Requirements

Check off when completed

Course	Cr
<input type="checkbox"/> HLTH 1421 Anatomy and Physiology for the Somatic Practitioner	4
<input type="checkbox"/> HLTH 1454 Yoga Postures/Asanas	3
<input type="checkbox"/> HLTH 1458 Relaxation Techniques	3
<input type="checkbox"/> HLTH 1459 Yoga Asana/Teaching Methodology	3
<input type="checkbox"/> HLTH 1541 Yoga History/Philosophy	3

Total Program Credits16

Program Start Dates

Fall, Spring, Summer

Course Sequence

For part-time or customized course sequence contact Jeremy Sartain at 651.846.1619 or email jeremy.sartain@saintpaul.edu.

Not all courses are offered each semester; a selection of courses is offered summer term. Students must take HLTH 1454 before taking HLTH 1459.

Students should consult with the Program Faculty each semester.

First Semester

HLTH 1421 Anatomy and Physiology for the Somatic Practitioner	4
HLTH 1454 Yoga Postures/Asanas	3
HLTH 1458 Relaxation Techniques	3
HLTH 1459 Yoga Asana/Teaching Methodology	3
HLTH 1541 Yoga History/Philosophy.	3

Total Program Credits16



*Information is subject to change.
This Program Requirements Guide is not a contract.*

Minimum Program Entry Requirements

Students entering this program must meet the following minimum program entry requirements:

Reading: Score of 38+

Assessment Results and Prerequisites: Students admitted into Saint Paul College programs may need to complete additional courses based on assessment results and course prerequisite requirements. Certain MATH, READ, and ENGL courses have additional prerequisites.

Degree option may have a greater requirement than this certificate.

373C

Service Programs

Child Development

Child Development Careers AS Degree (60 Credits)	147-148
Child Development Careers ASL AS Degree (60 Credits)	149-150
Child Development Careers AAS Degree (60 Credits)	151-152
Child Development Careers Diploma (32 Credits)	153
Child Development Careers Certificate (16 Credits)	154

Cosmetology

Cosmetology AAS Degree (70 Credits)	155-156
Cosmetology Diploma (57 Credits)	157-158
Nail Care Technician Certificate (16 Credits)	159

Culinary Arts

Culinary Arts AAS Degree (68 Credits)	160-161
Culinary Arts Diploma (58 Credits)	162-163
Culinary Foundations Certificate (18 credits)	164
Pastry and Baking Certificate (17 credits)	165
Wine Professional Certificate (9 Credits)	166

Sign Language Interpreter/Transliterater

Sign Language Interpreter/Transliterater AAS Degree (67 Credits)	167-168
---	---------

Child Development Careers AS DEGREE

Program Overview

This program is intended primarily for students who plan to transfer to another college or university to complete a bachelor's degree in Early Childhood or related field. It also prepares individuals for employment as a Teacher in a variety of early childhood settings.

Students will learn about child development, guidance, health and safety, cultural sensitivity, professional relations, and curriculum planning, as well as liberal arts education. Internship opportunities are provided which allow students to apply their skills and knowledge in a practical experience. All students must meet all reading and writing program entry requirements prior to entering courses beyond the Certificate.

Students must have a high school diploma, or GED, and pass a criminal background study. Respect for cultural differences is essential. Good judgment and absolute integrity are also necessary for success in the field of child development.

Career Opportunities

Graduates of the Child Development AS program may seek further education to earn a degree in early childhood education, early childhood special education, child development and family studies, psychology, or social work, but will also qualify to work at a child care center or preschool program, a family child care home or nanny, as well as a teacher in a Head Start program, a teacher assistant or education assistant in the public schools, Early Childhood Family Education, Early Childhood Special Education, or Child Life Assistant (hospital setting). If students go on for more education, the career opportunities (and pay scale) continue to increase.

The demand for trained child development professionals is increasing as more parents seek quality care and educational programs for their children. Our job placement rate is well over 95% and the Bureau of Labor Statistics estimates that the employment outlook will grow faster than average through 2026.

Program Outcomes

1. Graduates will demonstrate knowledge of child safety, health and nutrition.
2. Graduates will demonstrate knowledge in the fundamental principles of child development and developmentally appropriate practices.
3. Graduates will demonstrate knowledge and skills in positive child guidance techniques.
4. Graduates will demonstrate the knowledge and skills in positive family, community, and staff relations.
5. Graduates will demonstrate the knowledge and skills in developing and implementing early childhood curriculum.
6. Graduates will have hands-on training in a variety of Child Development settings.
7. Graduates will possess the knowledge and skills for immediate employment in the Child Development field.
8. Graduates will have successfully mastered the general education program requirements for work and life roles.

Program Faculty

Students should consult with the Program Faculty each semester.

Janet Massa janet.massa@saintpaul.edu
 Kelly McKown kelly.mckown@saintpaul.edu

Part-time/Full-time Options

Evening, Saturday, and online courses are also available.

Program Requirements

Check off when completed

Course	Cr
<input type="checkbox"/> CDEV 1200 Introduction to Early Childhood Education	3
<input type="checkbox"/> CDEV 1210 Child Growth and Development	3
<input type="checkbox"/> CDEV 1220 Health, Safety and Nutrition	3
<input type="checkbox"/> CDEV 1230 Guiding Children's Behavior	3
<input type="checkbox"/> CDEV 1240 Learning Environment and Curriculum	4
<input type="checkbox"/> CDEV 1610 Observation and Assessment	3
<i>Not offered every semester, see Faculty</i>	
<input type="checkbox"/> CDEV 1640 Curriculum Planning	3
<i>Not offered every semester, see Faculty</i>	
<input type="checkbox"/> CDEV 1910 Practicum 1	3
<input type="checkbox"/> CDEV 2320 Children with Differing Abilities (Fall)	3
<input type="checkbox"/> CDEV 2600 Organizational Leadership and Management (Spring)	2
Subtotal	30

*Information is subject to change.
 This Program Requirements Guide is not a contract.*

General Education/MnTC Requirements Cr

Refer to the Minnesota Transfer Curriculum Course List for each Goal Area

- Goal 1: Communication 7
 ENGL 1711 Composition 1 – 4 cr
 COMM 17XX – 3 cr
- Goal 3 or Goal 4 3
 Goal 3: Natural Sciences OR
 Goal 4: Mathematical/Logical Reasoning
- Goal 5: History, Social Science and Behavioral Sciences 4
 ANTH 1710, PSYC 1710, SOCI 1710, OR
 SOCI 1760 (recommended)
- Goal 6: Humanities and Fine Arts 3
- Goals 1-10 of the Minnesota Transfer Curriculum . . . 13
 Select a minimum of 13 additional credits

General Education Requirements 30

Total Program Credits 60

Course Sequence

The following sequence is recommended for a full-time student; however, this sequence is not required. Not all courses are offered each semester; a selection of courses is offered summer term.

See back of this guide for Course Sequence and Transfer Opportunities

Minimum Program Entry Requirements

Students entering this program must meet the following minimum program entry requirements:

Reading: Score of 78+ or grade of "C" or better in READ 0722

Writing: Score of 78+ or grade of "C" or better in ENGL 0922

Arithmetic: Score of 52+ or grade of "C" or better in MATH 0745

Assessment Results and Prerequisites: Students admitted into Saint Paul College programs may need to complete additional courses based on assessment results and course prerequisite requirements. Certain MATH, READ, and ENGL courses have additional prerequisites.

247S (7131)

Child Development Careers AS DEGREE *(continued)*

Program Start Dates

Fall, Spring, Summer

Course Sequence

The following sequence is recommended for a full-time student; however, this sequence is not required. Not all courses are offered each semester; a selection of courses is offered summer term.

First Semester

CDEV 1200 Introduction to Early Childhood Education	3
CDEV 1210 Child Growth and Development	3
CDEV 1220 Health, Safety and Nutrition	3
CDEV 1230 Guiding Children's Behavior	3
CDEV 1240 Learning Environment & Curriculum	4
Total Semester Credits	16

All students must meet all reading and writing program entry requirements prior to entering courses beyond the Certificate. CDEV 1200, 1210, 1220, 1230, and 1240 must be completed before taking CDEV courses.

Second Semester

CDEV 1610 Observation and Assessment	3
<i>Not offered every semester, see Faculty</i>	
CDEV 1640 Curriculum Planning.	3
<i>Not offered every semester, see Faculty</i>	
Goal 1: ENGL 1711 Composition 1.	4
Goal 1: COMM 17XX	3
Goal 3: Natural Sciences	
OR Goal 4: Mathematical/Logical Reasoning.	3
Total Semester Credits	16

Third Semester

CDEV 1910 Practicum 1	3
CDEV 2320 Children with Differing Abilities.	3
<i>Not offered every semester, see Faculty</i>	
Goal 5: History, Social Sciences and Behavioral Sciences	3
Goal 6: Humanities and Fine Arts	3
Total Semester Credits	12

Fourth Semester

CDEV 2600 Organizational Leadership and Management	2
<i>Not offered every semester, see Faculty</i>	
Goals 1-10: Minnesota Transfer Curriculum	14
Total Semester Credits	16

Total Program Credits60

Transfer Opportunities

Saint Paul College has a transfer articulation agreement between the following program and post-secondary institution for the baccalaureate degree program listed below.

For more information please go to saintpaul.edu/Transfer.

Child Development Careers AS

BA	Child Development Concordia University, St. Paul
BA	Family Science Concordia University, St. Paul
BA	Health Care Administration Concordia University, St. Paul
BAS	Early Childhood Studies Metropolitan State University
BS	Healthcare and Human Service Management Saint Mary's University, Twin Cities Campus
BS	Human Development & Family Studies University of Wisconsin, Stout

Child Development Careers ASL AS DEGREE

Program Overview

This program is intended primarily for students who plan to transfer to another college or university to complete a bachelor's degree in Early Childhood or related field. Students will learn about child development, guidance, health and safety, cultural sensitivity, and professional relations, as well as liberal arts education. Lab and Practicum opportunities are provided which allow students to apply their skills and knowledge in a practical experience. All students must meet all reading and writing program entry requirements prior to entering courses beyond the Certificate.

Students must have a high school diploma, or GED, and pass a criminal background study. Respect for cultural differences is essential. Good judgment and absolute integrity are also necessary for success in the field of child development.

Career Opportunities

Graduates of the Child Development Careers ASL AS Degree program may seek further education to earn a degree in early childhood education, early childhood special education, child development and family studies, psychology, or social work, but will also qualify to work at a child care center or preschool program, a family child care home or nanny, as well as a teacher in a Head Start program, a teacher assistant or education assistant in the public schools, Early Childhood Family Education, Early Childhood Special Education, or Child Life Assistant (working with children in a hospital setting).

Since this degree has a focus on using ASL in an early childhood setting, it increases employability for our graduates. If students go on for more education, the career opportunities (and pay scale) also increase. The demand for trained child development professionals continues to increase as more parents seek quality care and educational programs for their children. Our job placement rate is well over 95% and the Bureau of Labor Statistics estimates that the employment outlook will grow faster than average through 2026.

Program Outcomes

1. Graduates will demonstrate knowledge of child safety, health and nutrition.
2. Graduates will demonstrate knowledge in the fundamental principles of child development and developmentally appropriate practices.
3. Graduates will demonstrate knowledge and skills in positive child guidance techniques.
4. Graduates will demonstrate the knowledge and skills in positive family, community, and staff relations.
5. Graduates will demonstrate the knowledge and skills in developing and implementing early childhood curriculum.
6. Graduates will have hands-on training in a variety of Child Development settings.
7. Graduates will possess the knowledge and skills for immediate employment in the Child Development field.
8. Graduates will have successfully mastered the general education program requirements for work and life roles.

Program Faculty

Students should consult with the Program Faculty each semester.

Janet Massa janet.massa@saintpaul.edu
 Kelly McKown kelly.mckown@saintpaul.edu

Part-Time/Full-time Options

Part-time and full-time options are available. Evening, Saturday, and online courses are also available.

Program Requirements

Check off when completed

Course	Cr
<input type="checkbox"/> CDEV 1200 Introduction to Early Childhood Education	3
<input type="checkbox"/> CDEV 1210 Child Growth and Development	3
<input type="checkbox"/> CDEV 1220 Health, Safety and Nutrition	3
<input type="checkbox"/> CDEV 1230 Guiding Children's Behavior	3
<input type="checkbox"/> CDEV 1240 Learning Environment and Curriculum	4
<input type="checkbox"/> CDEV 2320 Children with Differing Abilities (Fall)	3
<input type="checkbox"/> CDEV 2560 Language & Literature Learning Experiences (Fall)	3
<input type="checkbox"/> CDEV 2599 Practicum 1: Special Settings/ASL	2
<input type="checkbox"/> ASLS 1411 American Sign Language 1	3
<input type="checkbox"/> ASLS 1412 American Sign Language 2	3
Subtotal	30

*Information is subject to change.
 This Program Requirements Guide is not a contract.*

General Education/MnTC Requirements Cr

Refer to the Minnesota Transfer Curriculum Course List for each Goal Area

- Goal 1: Communication7
 ENGL 1711 Composition 1 – 4 cr
 COMM 17XX – 3 cr
- Goal 3 or Goal 43
 Goal 3: Natural Sciences OR
 Goal 4: Mathematical/Logical Reasoning
- Goal 5: History, Social Science and Behavioral Sciences4
 ANTH 1710, PSYC 1710, SOCI 1710, or
 SOCI 1760 (recommended)
- Goal 6: Humanities and Fine Arts3
- Goal 8: Global Perspective6
 ASLS 1413 American Sign Language 3
 ASLS 1414 American Sign Language 4
- Goals 1-10 of the Minnesota Transfer Curriculum7
 Select a minimum of 7 additional credits

General Education Requirements 30

Total Program Credits 60

Program Start Dates

Fall, Spring, Summer

Course Sequence

The following sequence is recommended for a full-time student; however, this sequence is not required. Not all courses are offered each semester; a selection of courses is offered summer term.

See back of this guide for Course Sequence and Transfer Opportunities

Minimum Program Entry Requirements

Students entering this program must meet the following minimum program entry requirements:

Reading: Score of 78+ or grade of "C" or better in READ 0722

Writing: Score of 78+ or grade of "C" or better in ENGL 0922

Arithmetic: Score of 52+ or grade of "C" or better in MATH 0745

Assessment Results and Prerequisites: Students admitted into Saint Paul College programs may need to complete additional courses based on assessment results and course prerequisite requirements. Certain MATH, READ, and ENGL courses have additional prerequisites.

271S (7140)

Child Development Careers ASL AS DEGREE *(continued)*

Course Sequence

The following sequence is recommended for a full-time student; however, this sequence is not required. Not all courses are offered each semester; a selection of courses is offered summer term.

Students should consult with the Program Faculty each semester.

First Semester

CDEV 1200 Introduction to Early Childhood Education	3
CDEV 1210 Child Growth and Development	3
CDEV 1220 Health, Safety and Nutrition	3
CDEV 1230 Guiding Children's Behavior	3
ASLS 1411 American Sign Language 1	3
Total Semester Credits.	15

All students must meet all reading and writing program entry requirements prior to entering courses beyond the Certificate. CDEV 1200, 1210, 1220, and 1230 must be completed before taking other CDEV courses.

Second Semester

CDEV 1240 Learning Environment and Curriculum	4
ASLS 1412 American Sign Language 2	3
Goal 1: ENGL 1711 Composition 1	4
Goal 1: COMM 17XX	3
Total Semester Credits.	14

Third Semester

CDEV 2320 Children with Differing Abilities (Fall)	3
CDEV 2560 Language & Literature Learning Experiences (Fall)	3
ASLS 1413 American Sign Language 3	3
Goal 3: Natural Sciences	
OR Goal 4: Mathematical/Logical Reasoning	3
Goal 5: History, Social Sciences and Behavioral Sciences	3
Total Semester Credits.	15

Fourth Semester

CDEV 2599 Practicum 1: Special Settings/ASL	2
ASLS 1414 American Sign Language 4	3
Goal 6: Humanities and Fine Arts	3
Goals 1-10: Minnesota Transfer Curriculum	8
Total Semester Credits.	16

NOTE: ASLS 1413 & ASLS 1414 are counted towards fulfilling MnTC Electives

Total Program Credits60

Transfer Opportunities

Saint Paul College has a transfer articulation agreement between the following program and post-secondary institution for the baccalaureate degree program listed below.

For more information please go to saintpaul.edu/Transfer.

Child Development Careers ASL AS

BA	Health Care Administration Concordia University, St. Paul
BA	Individualized Studies Metropolitan State University
BS	Healthcare and Human Service Management Saint Mary's University, Twin Cities Campus
BS	Human Development & Family Studies University of Wisconsin, Stout

Child Development Careers AAS DEGREE

Program Overview

This program is designed to prepare individuals for employment as a teacher in a variety of early childhood settings. Students will learn how to promote and communicate knowledge of child development; create healthy, respectful and challenging learning environments; create and maintain respectful and supportive relationships with children, families, staff, and community members; use observation skills to enhance teaching; and design and implement developmentally and culturally appropriate activities and curriculum. Lab and Practicum opportunities are provided which allow students to apply their skills and knowledge in a practical experience. All students must meet all reading and writing program entry requirements prior to entering courses beyond the Certificate.

Students must have a high school diploma, or GED, and pass a criminal background study. Respect for cultural differences is essential. Good judgment and absolute integrity are also necessary for success in the field of child development.

Career Opportunities

Graduates of the Child Development AAS program will qualify to teach at a child care center, preschool program, before/after-school program, a family child care home or nanny, as well as a Lead Teacher in a Head Start program, a teacher assistant or education assistant (paraprofessional) in the public schools, Early Childhood Family Education, Early Childhood Special Education, or Child Life Assistant (in a hospital setting). The AAS degree meets Minnesota Department of Human Services educational requirements for child care providers. The demand for trained child development professionals continues to increase as more parents seek quality care and educational programs for their children. Our job placement rate is well over 95% and the Bureau of Labor Statistics estimates that the employment outlook will grow faster than average through 2026.

Program Outcomes

1. Graduates will demonstrate knowledge of child safety, health, and nutrition.
2. Graduates will demonstrate knowledge on the principles of child development and developmentally appropriate practices.
3. Graduates will demonstrate knowledge and skills in positive child guidance techniques.
4. Graduates will demonstrate the knowledge and skills in positive family, community, and staff relations.
5. Graduates will demonstrate the knowledge and skills in developing and implementing early childhood curriculum.
6. Graduates will have hands-on training in a variety of Child Development settings.
7. Graduates will possess the knowledge and skills for immediate employment in the Child Development field.

Program Faculty

Students should consult with the Program Faculty each semester.

Janet Massa janet.massa@saintpaul.edu
 Kelly McKown kelly.mckown@saintpaul.edu

Part-time/Full-time Options

Part-time and full-time options are available. Evening, Saturday, and online courses are also available.

Program Requirements

Check off when completed

Course	Cr
<input type="checkbox"/> CDEV 1200 Introduction to Early Childhood Education	3
<input type="checkbox"/> CDEV 1210 Child Growth and Development	3
<input type="checkbox"/> CDEV 1220 Health, Safety and Nutrition	3
<input type="checkbox"/> CDEV 1230 Guiding Children's Behavior	3
<input type="checkbox"/> CDEV 1240 Learning Environment and Curriculum	4
<input type="checkbox"/> CDEV 1610 Observation and Assessment	3
<i>Not offered every semester, see Faculty</i>	
<input type="checkbox"/> CDEV 1640 Curriculum Planning	3
<i>Not offered every semester, see Faculty</i>	
<input type="checkbox"/> CDEV 1910 Practicum 1	3
<input type="checkbox"/> CDEV 2320 Children with Differing Abilities (Fall)	3
<input type="checkbox"/> CDEV 2600 Organizational Leadership and Management (Spring)	2
<input type="checkbox"/> CDEV 2560 Language & Literature Learning Experiences OR CDEV 2550 STEM for ECE	3
<input type="checkbox"/> CDEV 2620 Practicum 2	4
Subtotal	37
Electives: Choose a minimum of 3 credits from the following Technical Electives:	
<input type="checkbox"/> CDEV 2530 Children with Challenging Behaviors	3
<input type="checkbox"/> CDEV 2550 STEM for ECE	3
<input type="checkbox"/> CDEV 2560 Language & Literature Learning Experiences	3
<input type="checkbox"/> CDEV 2570 Working with Diverse Children and Families	3
<input type="checkbox"/> CDEV 2597 Special Topics	1-4

*Information is subject to change.
 This Program Requirements Guide is not a contract.*

General Education/MnTC Requirements Cr

Refer to the Minnesota Transfer Curriculum Course List for each Goal Area

- Goal 1: Communication7
 ENGL 1711 Composition 1 – 4 cr
 COMM 17XX – 3 cr
 - Goal 3 or Goal 4.3
 Goal 3: Natural Sciences OR
 Goal 4: Mathematical/Logical Reasoning
 - Goal 5: History, Social Science and Behavioral Sciences3
 SOCI 1720 Social Problems OR SOCI 1730 Sociology of Families & Relationships (recommended)
 - Goal 6: Humanities and Fine Arts.3
 - Goals 1-10 of the Minnesota Transfer Curriculum4
 Select a minimum of 4 additional credits
- General Education Requirements 20**

Total Program Credits 60

Program Start Dates

Fall, Spring, Summer

Course Sequence

The course sequence on the back of this guide is recommended for a full-time student; however, this sequence is not required. Not all courses are offered each semester; a selection of courses is offered summer term.

*See back of this guide for
 Course Sequence and Transfer Opportunities*

Minimum Program Entry Requirements

Students entering this program must meet the following minimum program entry requirements:

Reading: Score of 78+ or grade of "C" or better in READ 0722

Writing: Score of 78+ or grade of "C" or better in ENGL 0922

Arithmetic: Score of 20+

Assessment Results and Prerequisites:
 Students admitted into Saint Paul College programs may need to complete additional courses based on assessment results and course prerequisite requirements. Certain MATH, READ, and ENGL courses have additional prerequisites.

053A (7009)

Child Development Careers AAS DEGREE *(continued)*

Course Sequence

The course sequence is recommended for a full-time student; however, this sequence is not required.

Not all courses are offered each semester; a selection of courses is offered summer term.

Students should consult with the Program Faculty each semester.

First Semester

CDEV 1200 Introduction to Early Childhood Education	3
CDEV 1210 Child Growth and Development	3
CDEV 1220 Health, Safety and Nutrition	3
CDEV 1230 Guiding Children's Behavior	3
CDEV 1240 Learning Environment and Curriculum	4
Total Semester Credits.	16

All students must meet all reading and writing program entry requirements prior to entering courses beyond the Certificate. CDEV 1200, 1210, 1220, 1230, and 1240 must be completed before taking other CDEV courses.

Second Semester

CDEV 1610 Observation and Assessment	3
<i>Not offered every semester, see Faculty</i>	
CDEV 1640 Curriculum Planning.	3
<i>Not offered every semester, see Faculty</i>	
Goal 1: ENGL 1711 Composition 1.	4
Goal 1: COMM 17XX	3
Goal 3: Natural Sciences	
OR Goal 4: Mathematical/Logical Reasoning.	3
Total Semester Credits.	16

Third Semester

CDEV 1910 Practicum 1	3
CDEV 2320 Children with Differing Abilities (fall only)	3
<i>Not offered every semester, see Faculty</i>	
CDEV Technical Elective	3
Goal 5: History, Social Sciences and Behavioral Sciences	3
Goal 6: Humanities and Fine Arts.	3
Total Semester Credits.	15

Fourth Semester

CDEV 2560 Language & Literature Learning Experiences OR CDEV 2550 STEM for ECE	3
<i>Not offered every semester, see Faculty</i>	
CDEV 2600 Organizational Leadership & Management (spring only)	2
CDEV 2620 Practicum 2	4
<i>Not offered every semester, see Faculty</i>	
Goals 1-10: Minnesota Transfer Curriculum	4
Total Semester Credits.	13

Total Program Credits60

Transfer Opportunities

Saint Paul College has a transfer articulation agreement between the following program and post-secondary institution for the baccalaureate degree program listed below.

For more information please go to saintpaul.edu/Transfer.

Child Development Careers AAS

BA	Child Development Concordia University, St. Paul
BA	Family Science Concordia University, St. Paul
BA	Health Care Administration Concordia University, St. Paul
BAS	Early Childhood Studies Metropolitan State University
BS	Healthcare and Human Service Management Saint Mary's University, Twin Cities Campus
BS	Human Development & Family Studies University of Wisconsin-Stout

Child Development Careers DIPLOMA

Program Overview

This program is designed to prepare individuals for employment in entry-level early childhood education positions. Students will learn about child development, guidance, health and safety, professional relations, and strategies for promoting learning in young children.

Lab and practicum opportunities are provided which allow students to apply their skills and knowledge in a practical experience. All students must meet all reading and writing program entry requirements prior to entering courses beyond the Certificate.

Students must have a high school diploma or GED and pass a criminal background study. Respect for cultural differences is essential. Good judgment and absolute integrity are also necessary for success in the field of child development.

Career Opportunities

Graduates of the Child Development Diploma program will qualify to work at a child care center, preschool program, before/after-school program, a family child care home or nanny. This diploma meets Minnesota Department of Human Services educational requirements for child care providers. The demand for trained child development professionals continues to increase as more and more parents seek quality care and educational programs for their children. Our job placement rate is well over 95% and the Bureau of Labor Statistics estimates that the employment outlook will grow faster than average through 2026.

Program Outcomes

1. Graduates will demonstrate knowledge of child safety, health and nutrition.
2. Graduates will demonstrate knowledge in the fundamental principles of child development and developmentally appropriate practices.
3. Graduates will demonstrate knowledge and skills in positive child guidance techniques.
4. Graduates will demonstrate the knowledge and skills in positive family, community, and staff relations.
5. Graduates will demonstrate the knowledge and skills in developing and implementing early childhood curriculum.

Program Faculty

Students should consult with the Program Faculty each semester.

Janet Massa janet.massa@saintpaul.edu

Kelly McKown kelly.mckown@saintpaul.edu

Part-time/Full-time Options

Part-time and full-time options are available. Evening, Saturday, and online courses are also available.

Program Requirements

Check off when completed

Course	Cr
<input type="checkbox"/> CDEV 1200 Introduction to Early Childhood Education	3
<input type="checkbox"/> CDEV 1210 Child Growth and Development	3
<input type="checkbox"/> CDEV 1220 Health, Safety and Nutrition	3
<input type="checkbox"/> CDEV 1230 Guiding Children's Behavior	3
<input type="checkbox"/> CDEV 1240 Learning Environment and Curriculum	4
<input type="checkbox"/> CDEV 1610 Observation and Assessment	3
<input type="checkbox"/> CDEV 1640 Curriculum Planning	3
<input type="checkbox"/> CDEV 1910 Practicum 1	3
Subtotal	25

General Education Requirements	Cr
<input type="checkbox"/> Goal 1: Communication	4
ENGL 1711 Composition 1	
<input type="checkbox"/> Goal 5: History, Social Science and Behavioral Sciences	3
SOCI 1720 Social Problems OR	
SOCI 1730 Sociology of Families and Relationships (recommended)	
General Education Requirements	7

Total Program Credits 32

Program Start Dates

Fall, Spring, Summer

Course Sequence

The following sequence is recommended for a full-time student; however, this sequence is not required. Not all courses are offered each semester; a selection of courses is offered summer term.

First Semester

CDEV 1200 Introduction to Early Childhood Education	3
CDEV 1210 Child Growth and Development	3
CDEV 1230 Guiding Children's Behavior	3
CDEV 1240 Learning Environment & Curriculum	4
Total Semester Credits	13

All students must meet all reading and writing program entry requirements prior to entering courses beyond the Certificate. CDEV 1200, 1210, 1230, and 1240 must be completed before taking CDEV courses.

Second Semester

CDEV 1220 Health, Safety and Nutrition	3
CDEV 1610 Observation and Assessment	3
CDEV 1640 Curriculum Planning	3
<i>Not offered every semester, see Faculty</i>	
Goal 5: SOCI 1720 Social Problems	3
OR SOCI 1730 (recommended)	3
Total Semester Credits	12

Third Semester

CDEV 1910 Practicum 1	3
Goal 1: ENGL 1711 Composition 1	4
Total Semester Credits	7

Total Program Credits 32

Minimum Program Entry Requirements

Students entering this program must meet the following minimum program entry requirements:

Reading: Score of 78+ or grade of "C" or better in READ 0722

Writing: Score of 78+ on Reading Comprehension or grade of "C" or better in ENGL 0922

Arithmetic: Score of 20+

Assessment Results and Prerequisites: Students admitted into Saint Paul College programs may need to complete additional courses based on assessment results and course prerequisite requirements. Certain MATH, READ, and ENGL courses have additional prerequisites.

052D (7007)

*Information is subject to change.
This Program Requirements Guide is not a contract.*

Child Development Careers CERTIFICATE

Program Overview

This program is designed to give students an introduction to the field of Early Childhood Education and the variety of possibly career opportunities. Each of our other programs begin with the Certificate-level courses. Students will learn about child development, guidance, health and safety, professional relations, and strategies for promoting learning in young children.

Students must have a high school diploma, or GED, and pass a criminal background study. Respect for cultural differences is essential. Good judgment and absolute integrity are also necessary for success in the field of child development.

Career Opportunities

Graduates of the Child Development Certificate program will qualify to work at a child care center, preschool program, before/after-school program, a family child care home or nanny. This certificate meets Minnesota Department of Human Services educational requirements for child care provider. The demand for trained child development professionals continues to increase as more and more parents seek quality care and educational programs for their children. Our job placement rate is well over 95% and the Bureau of Labor Statistics estimates that the employment outlook will grow faster than average through 2026.

Program Outcomes

1. Graduates will demonstrate knowledge of child safety, health and nutrition.
2. Graduates will demonstrate knowledge in the fundamental principles of child development and developmentally appropriate practices.
3. Graduates will demonstrate knowledge and skills in positive child guidance techniques.
4. Graduates will demonstrate the knowledge and skills in positive family, community, and staff relations.

Program Faculty

Students should consult with the Program Faculty each semester.

Janet Massa janet.massa@saintpaul.edu
 Kelly McKown kelly.mckown@saintpaul.edu

Part-time/Full-time Options

Part-time and full-time options are available. Evening, Saturday, and online courses are also available.

Program Requirements

Check off when completed

Course	Cr
<input type="checkbox"/> CDEV 1200 Introduction to Early Childhood Education	3
<input type="checkbox"/> CDEV 1210 Child Growth and Development	3
<input type="checkbox"/> CDEV 1220 Health, Safety and Nutrition	3
<input type="checkbox"/> CDEV 1230 Guiding Children’s Behavior	3
<input type="checkbox"/> CDEV 1240 Learning Environment and Curriculum	4
Total Program Credits	16

Program Start Dates

Fall, Spring

Course Sequence

This certificate can be completed in one semester as shown in the following sequence. Not all courses are offered each semester; a selection of courses is offered summer term.

First Semester

CDEV 1200 Introduction to Early Childhood Education	3
CDEV 1210 Child Growth and Development	3
CDEV 1220 Health, Safety and Nutrition	3
CDEV 1230 Guiding Children’s Behavior	3
CDEV 1240 Learning Environment and Curriculum	4
Total Semester Credits	16

Total Program Credits 16

**This certificate can also be completed over two or more semesters.*

*Information is subject to change.
 This Program Requirements Guide is not a contract.*

Minimum Program Entry Requirements
 Students entering this program must meet the following minimum program entry requirements:

Reading: Score of 60+ on Reading Comprehension or grade of “C” or better in READ 0721

Arithmetic: Score of 20+

Assessment Results and Prerequisites:
 Students admitted into Saint Paul College programs may need to complete additional courses based on assessment results and course prerequisite requirements. Certain MATH, READ, and ENGL courses have additional prerequisites.

051C (7006)

Cosmetology AAS DEGREE

Program Overview

The Cosmetology AAS degree meets the requirements for licensure by the Minnesota Board of Cosmetologist Examiners and provides transferrable credits towards a two- or four-year degree in liberal arts and sciences.

Cosmetology services include the cleaning, conditioning, shaping, reinforcing, coloring and enhancing of the body surface in the areas of head, scalp, face, arms, hands, legs and feet.

Science courses provide a good background for the skills taught in hair analysis and treatment. Physical requirements include finger dexterity, negative allergic reaction to cosmetic preparations and artistic flair for creative design. The professional cosmetologist should enjoy working with the public and in a team atmosphere. People skills and time management skills are essential.

Licensing or certification exams are independent of graduation requirements.

Career Opportunities

The job outlook is good for cosmetologists, estheticians and nail technicians. Increasing population, incomes, and demand for cosmetology services will stimulate job growth. In addition, numerous job openings will stem from rapid turnover in salons and the large size of the occupation. The rapid growth of nail salons and full-service spas will generate numerous job openings for cosmetologists skilled in hair, skin, and nails.

After cosmetology students complete 1550 hours of skills and theory training and pass the written exam given through the State designated testing service and skills certification, they are eligible for licensure through the Minnesota Board of Cosmetologist Examiners. Cosmetologists work in a variety of settings including beauty salons and full service spas.

Program Outcomes

1. Graduates will be prepared to take the skills certification.
2. Graduates will be prepared to take the Minnesota State Cosmetology written exam and state law test administered through the State designated testing service (access through www.bceboard.state.mn.us).
3. Graduates will have knowledge and skills in cosmetology services (hair, nails and skin).
4. Graduates will have knowledge and skills in salon operations.
5. Graduates will be prepared for employment as Cosmetologists.
6. Graduates will have successfully mastered the general education program requirements for work and life roles.

Program Faculty

Marcie Smith-Fields
marcie.smith-fields@saintpaul.edu

Full-time

Students attend full-time and can complete the program in four semesters.

Licensure

This program meets Minnesota Board of Cosmetologist Examiners requirements.

Textbook and Supply Costs

Students should expect to spend approximately \$3,700.00 for cosmetology kits, supplies, and books. This cost is in addition to tuition and fees.

Program Requirements

- Check off when completed
- Required Program Orientation**
 All Cosmetology, Esthetics and Nail Technician applicants must attend a program orientation prior to enrollment as a full-time student. Please call the Clinic receptionist at 651.846.1329 to reserve your space at a orientation.

Courses	Cr
<input type="checkbox"/> CHSN 1598 Body Systems & Diseases	4
<input type="checkbox"/> CHSN 1599 Preclinic Introduction	4
<input type="checkbox"/> COSM 1601 Preclinic Hair Care 1	3
<input type="checkbox"/> COSM 1602 Preclinic Hair Care 2	3
<input type="checkbox"/> COSM 1603 Preclinic Nail Care	3
<input type="checkbox"/> COSM 1604 Preclinic Skin Care	3
<input type="checkbox"/> COSM 1605 Preclinic Hair Color	3
<input type="checkbox"/> COSM 1606 Preclinic Chemical Control	3
<input type="checkbox"/> COSM 1620 Advanced Hair Care	4
<input type="checkbox"/> COSM 1901 Clinic 1 for Cosmetology Majors	3
<input type="checkbox"/> COSM 1902 Clinic 2 for Cosmetology Majors	3
<input type="checkbox"/> COSM 1903 Clinic 3 for Cosmetology Majors	3
<input type="checkbox"/> COSM 1904 Clinic 4 for Cosmetology Majors	3
<input type="checkbox"/> COSM 1905 Clinic 5 for Cosmetology Majors	3
<input type="checkbox"/> COSM 1906 Clinic 6 for Cosmetology Majors	3
<input type="checkbox"/> COSM 1907 Clinic 7 for Cosmetology Majors	3
General Education Requirements	51
Required Technical Electives	3
Select 3 credits from the following Technical Electives to complete the required 1550 hours needed for licensure:	
COSM 1951 Salon Operations 1 for Cosmetology/Nail Technician Majors	1
COSM 1952 Salon Operations 2 for Cosmetology/Nail Technician Majors	2
COSM 1953 Salon Operations 3 for Cosmetology/Nail Technician Majors	3
COSM 1954 Salon Operations 4 for Cosmetology/Nail Technician Majors	4
COSM 1955 Salon Operations 5 for Cosmetology/Nail Technician Majors	5
COSM 1956 Salon Operations 6 for Cosmetology/Nail Technician Majors	6

General Education/MnTC Requirements	Cr
Refer to the Minnesota Transfer Curriculum Course List for each Goal Area	
<input type="checkbox"/> Goal 1: Communication	7
ENGL 1711 Composition 1 – 4 cr	
COMM 17XX (COMM 1720 -Interpersonal Communication recommended) – 3 cr	
<input type="checkbox"/> Goal 3 or Goal 4	3
Goal 3: Natural Sciences	
OR Goal 4: Mathematical/Logical Reasoning	
<input type="checkbox"/> Goal 5: History, Social Science and Behavioral Sciences	3
<input type="checkbox"/> Goal 6: Humanities and Fine Arts	3
General Education Requirements	16
Total Program Credits	70

Additional Requirements

Be prepared to purchase student cosmetology kits the first day of class from the book store. Financial aid must have been completed.

All books MUST be purchased before classes begin.

Cosmetology Student Handbook/ Agreement Form

All new and returning students will need to access D2L Brightspace PRIOR to the first day of classes to read the Cosmetology student handbook. After you have read the handbook, you must print and sign Student Agreement Form, Hepatitis B Vaccination/Declination Form and Rollabout Form and return them to your instructor on the first day of class before you will be admitted to class. You will need to perform this task prior to the first day of each semester.

Please direct questions to the assigned instructor of your first class.

Course Sequence

The course sequence listed on the back of this guide is recommended for a full-time student; however, this sequence is not required. Contact Program Faculty with questions.

See back of this guide for Course Sequence and Transfer Opportunities

Cosmetology AAS DEGREE *(continued)*

Program Start Dates

Fall, Spring,
Summer – online only CHSN 1598 & CHSN 1599

Course Sequence

Required course sequence is dependent upon which Semester/Term the student starts the Cosmetology AAS Degree Program. The General Education courses (16 credits) may be taken during the Semester/Term of student's choice or after completion of Technical Requirement courses.

IF YOU START THE PROGRAM FALL OR SPRING SEMESTER:

Course	Cr/HR
First Semester	
CHSN 1598 Body Systems & Disease	4/80
CHSN 1599 Preclinic Introduction	4/80
COSM 1601 Preclinic Hair Care	3/96
COSM 1602 Preclinic Hair Care	3/80
COSM 1603 Preclinic Nail Care	3/80
COSM 1604 Preclinic Skin Care	3/80
COSM 1901 Clinic 1 for Cosmetology Majors . . .	3/96
COSM 1902 Clinic 2 for Cosmetology Majors . . .	3/96
COSM 1903 Clinic 3 for Cosmetology Majors . . .	3/96
Total Semester Credits	29/784

Second Semester

COSM 1605 Preclinic Hair Color	3/80
COSM 1606 Preclinic Chemical Control	3/80
COSM 1620 Advanced Hair Care	4/128
COSM 1904 Clinic 4 for Cosmetology Majors . . .	3/96
COSM 1905 Clinic 5 for Cosmetology Majors . . .	3/96
COSM 1906 Clinic 6 for Cosmetology Majors . . .	3/96
COSM 1951 Salon Operations 1 for Cosmetology/Nail	1/32
Total Semester Credits	20/608

Third Semester

COSM 1907 Clinic 7 for Cosmetology Majors . . .	3/96
COSM 1952 Salon Operations 2 for Cosmetology/Nail Tech Majors	2/64
Total Semester Credits	5/160
Subtotal Program Credits	54/1552

Any Semester

Goal 1: ENGL 1711 Composition 1	4
Goal 1: COMM 17XX (COMM 1720 -Interpersonal Communication recommended)	3
Goal 3 or 4: Natural Sciences OR Mathematical/Logical Reasoning	3
Goal 5: History, Social Science and Behavioral Sciences	3
Goal 6: Humanities and Fine Arts	3
General Education Requirements	16

Total Program Credits: 70/1552

Transfer Opportunities

Saint Paul College has a transfer articulation agreement between the following program and post-secondary institution for the baccalaureate degree program listed below.

For more information please go to saintpaul.edu/Transfer.

Cosmetology AAS

- BA Health Care Administration
Concordia University, St. Paul
- BA Individualized Studies
Metropolitan State University

Minimum Program Entry Requirements

Students entering this program must meet the following minimum program entry requirements:

Reading: Score of 78+ or grade of "C" or better in READ 0722

Writing: Score of 78+ or grade of "C" or better in ENGL 0922

Arithmetic: Score of 31+

Assessment Results and Prerequisites:
Students admitted into Saint Paul College programs may need to complete additional courses based on assessment results and course prerequisite requirements. Certain MATH, READ, and ENGL courses have additional prerequisites.

135A (7123)

*Information is subject to change.
This Program Requirements Guide is not a contract.*

pivot point.
MEMBER SCHOOL

Pivot Point is a registered service mark and trademark owned by Pivot Point International, Inc.

Saint Paul College's Cosmetology Program is a Pivot Point Member School

Pivot Point International Inc.
1560 Sherman Avenue Suite 700
Evanston, IL 60201
1.800.886.4247
www.pivot-point.com

Cosmetology DIPLOMA

Program Overview

The Cosmetology Diploma program meets the requirements for licensure by the Minnesota Board of Cosmetologist Examiners.

Cosmetology services include the cleaning, conditioning, shaping, reinforcing, coloring and enhancing of the body surface in the areas of head, scalp, face, arms, hands, legs and feet.

Science courses provide a good background for the skills taught in hair analysis and treatment. Physical requirements include finger dexterity, negative allergic reaction to cosmetic preparations and artistic flair for creative design. The professional cosmetologist should enjoy working with the public and in a team atmosphere. People skills and time management skills are essential.

Licensing or certification exams are independent of graduation requirements.

Career Opportunities

The job outlook is good for cosmetologists. Increasing population, incomes, and demand for cosmetology services will stimulate job growth. In addition, numerous job openings will stem from rapid turnover in salons and the large size of the occupation. The rapid growth of nail salons and full-service spas will generate numerous job openings for cosmetologists skilled in hair, skin, and nails.

After cosmetology students complete 1550 hours of skills and theory training and pass the written exam given through the State designated testing service and skills certification, they are eligible for licensure through the Minnesota Board of Cosmetologist Examiners. Cosmetologists work in a variety of settings including beauty salons and full service spas.

Program Outcomes

1. Graduates will be prepared to take the skills certification.
2. Graduates will be prepared to take the Minnesota State Cosmetology written exam and state law test administered through the State designated testing service (access through www.bceboard.state.mn.us).
3. Graduates will have knowledge and skills in cosmetology services (hair, nails and skin).
4. Graduates will have knowledge and skills in salon operations.
5. Graduates will be prepared for employment as Cosmetologists.
6. Graduates will have successfully mastered the general education program requirements for work and life roles.

*Information is subject to change.
This Program Requirements Guide is not a contract.*

Program Faculty

Marcie Smith-Fields
marcie.smith-fields@saintpaul.edu

Full-time

Students attend full-time and can complete the program in three semesters.

Licensure

This program meets Minnesota Board of Cosmetologist Examiners requirements.

Textbook and Supply Costs

Students should expect to spend approximately \$3,700.00 for cosmetology kits, supplies, and books. This cost is in addition to tuition and fees.

Program Requirements

- Check off when completed
- Required Program Orientation**
All Cosmetology, Esthetics and Nail Technician applicants must attend a program orientation prior to enrollment as a full-time student. Please call the Clinic receptionist at 651.846.1329 to reserve your space at a orientation.

Courses	Cr
<input type="checkbox"/> CHSN 1598 Body Systems & Diseases	4
<input type="checkbox"/> CHSN 1599 Preclinic Introduction	4
<input type="checkbox"/> COSM 1601 Preclinic Hair Care 1	3
<input type="checkbox"/> COSM 1602 Preclinic Hair Care 2	3
<input type="checkbox"/> COSM 1603 Preclinic Nail Care	3
<input type="checkbox"/> COSM 1604 Preclinic Skin Care	3
<input type="checkbox"/> COSM 1605 Preclinic Hair Color.	3
<input type="checkbox"/> COSM 1606 Preclinic Chemical Control	3
<input type="checkbox"/> COSM 1620 Advanced Hair Care	4
<input type="checkbox"/> COSM 1901 Clinic 1 for Cosmetology Majors . . .	3
<input type="checkbox"/> COSM 1902 Clinic 2 for Cosmetology Majors . . .	3
<input type="checkbox"/> COSM 1903 Clinic 3 for Cosmetology Majors . . .	3
<input type="checkbox"/> COSM 1904 Clinic 4 for Cosmetology Majors . . .	3
<input type="checkbox"/> COSM 1905 Clinic 5 for Cosmetology Majors . . .	3
<input type="checkbox"/> COSM 1906 Clinic 6 for Cosmetology Majors . . .	3
<input type="checkbox"/> COSM 1907 Clinic 7 for Cosmetology Majors . . .	3
Subtotal	51
Required Technical Electives	3
Select 3 credits from the following Technical Electives to complete the required 1550 hours needed for licensure:	
COSM 1951 Salon Operations 1 for Cosmetology/Nail Technician Majors	1
COSM 1952 Salon Operations 2 for Cosmetology/Nail Technician Majors	2
COSM 1953 Salon Operations 3 for Cosmetology/Nail Technician Majors	3
COSM 1954 Salon Operations 4 for Cosmetology/Nail Technician Majors	4
COSM 1955 Salon Operations 5 for Cosmetology/Nail Technician Majors	5
COSM 1956 Salon Operations 6 for Cosmetology/Nail Technician Majors	6

General Education/MnTC Requirements Cr

Refer to the Minnesota Transfer Curriculum Course List for each Goal Area

- Goals 1-10: Minnesota Transfer Curriculum
COMM 1720 -Interpersonal Communication (recommended)

Total Program Credits 57

Additional Requirements

Purchase Kits

Be prepared to purchase student cosmetology kits the first day of class from the book store. Financial aid must have been completed.

All books MUST be purchased before classes begin.

Cosmetology Student Handbook/ Agreement Form

All new and returning students will need to access D2L Brightspace PRIOR to the first day of classes to read the Cosmetology student handbook. After you have read the handbook, you must print and sign Student Agreement Form, Hepatitis B Vaccination/Declination Form and Rollabout Form and return them to your instructor on the first day of class before you will be admitted to class. You will need to perform this task prior to the first day of each semester. Please direct questions to the assigned instructor of your first class.

Course Sequence

The course sequence listed on the back of this guide is recommended for a full-time student; however, this sequence is not required. Contact Program Faculty with questions.

See back of this guide for Course Sequence

Minimum Program Entry Requirements

Students entering this program must meet the following minimum program entry requirements:

Reading: Score of 60+ on Reading Comprehension or grade of "C" or better in READ 0721

Writing: Any

Arithmetic: Score of 31+

Assessment Results and Prerequisites: Students admitted into Saint Paul College programs may need to complete additional courses based on assessment results and course prerequisite requirements. Certain MATH, READ, and ENGL courses have additional prerequisites.

054D (7012)

Cosmetology DIPLOMA *(continued)*

Program Start Dates

Fall, Spring,
Summer – online only CHSN 1598 & CHSN 1599

Course Sequence

Required course sequence is dependent upon which Semester/Term the student starts the Cosmetology Diploma Program. The General Education Requirement (3 credits) may be taken during the Semester/Term of student's choice.

IF YOU START THE PROGRAM

FALL OR SPRING SEMESTER:

Course	Cr/HR
--------	-------

First Semester

CHSN 1598 Body Systems & Disease	4/80
CHSN 1599 Preclinic Introduction	4/80
COSM 1601 Preclinic Hair Care	3/96
COSM 1602 Preclinic Hair Care	3/80
COSM 1603 Preclinic Nail Care	3/80
COSM 1604 Preclinic Skin Care	3/80
COSM 1901 Clinic 1 for Cosmetology Majors . . .	3/96
COSM 1902 Clinic 2 for Cosmetology Majors . . .	3/96
COSM 1903 Clinic 3 for Cosmetology Majors . . .	3/96
Total Semester Credits	29/784

Second Semester

COSM 1605 Preclinic Hair Color	3/80
COSM 1606 Preclinic Chemical Control	3/80
COSM 1620 Advanced Hair Care	4/128
COSM 1904 Clinic 4 for Cosmetology Majors . . .	3/96
COSM 1905 Clinic 5 for Cosmetology Majors . . .	3/96
COSM 1906 Clinic 6 for Cosmetology Majors . . .	3/96
COSM 1951 Salon Operations 1 for Cosmetology/Nail	1/32
Total Semester Credits	20/608

Third Semester

COSM 1907 Clinic 7 for Cosmetology Majors . . .	3/96
COSM 1952 Salon Operations 2 for Cosmetology/Nail Tech Majors	2/64
Total Semester Credits	5/160
Subtotal Program Credits	54/1552

ANY SEMESTER

Any Semester

General Education Requirements (Semester of Choice)
Goal 1: COMM 17XX (COMM 1720 -Interpersonal
Communication recommended). 3
General Education Requirements 3

Total Program Credits: 57/1552

pivot point.
MEMBER SCHOOL

Pivot Point is a registered service mark and trademark owned by Pivot Point International, Inc.

Saint Paul College's Cosmetology Program is a Pivot Point Member School

Pivot Point International Inc.
1560 Sherman Avenue Suite 700
Evanston, IL 60201
1.800.886.4247
www.pivot-point.com

Nail Care Technician CERTIFICATE

Program Overview

Nail Technician services include the cleaning, shaping, conditioning and care for the fingers, hands, toes and feet as well as the preparation and application of artificial nails.

Physical requirements include finger dexterity, negative allergic reaction to cosmetic preparations, and artistic flair for creative design. The nail technician should enjoy working with the public and in a team atmosphere. People skills and time management skills are essential.

Licensing or certification exams are independent of graduation requirements.

Career Opportunities

The job outlook is very good for nail technicians. Increasing population, incomes, and demand for cosmetology services will stimulate job growth. In addition, numerous job openings will stem from rapid turnover in salons and the large size of the occupation. The rapid growth of nail salons and full service spas will generate numerous job openings for nail technicians.

After Nail Care Technician students complete 350 hours of skills and theory training and pass the written exam given through the State designated testing service, and skills certification they are eligible for licensure from the Minnesota Board of Cosmetologist Examiners. Nail technicians work in beauty salons, nail salons and spas.

Program Outcomes

1. Graduates will be prepared to take the skills certification.
2. Graduates will be prepared to take the Minnesota State written exam and state law test administered through the State designated testing service (access through www.bceboard.state.mn.us).
3. Graduates will possess knowledge and skills for manicures, pedicures and application of artificial nails.

Program Faculty

Marcie Smith-Fields
marcie.smith-fields@saintpaul.edu

Full-time

Students may complete the program in one semester. Consult with Cosmetology Instructor to develop a plan.

Additional Costs

Students should expect to spend approximately \$700.00 for nail care kits, supplies and books. This cost is in addition to tuition and fees. There is an additional fee to take the licensure exam.

Program Requirements

Check off when completed

- Required Program Orientation**
All Cosmetology, Esthetics and Nail Technician applicants must attend a program orientation prior to enrollment as a full-time student. Please call the Clinic receptionist at 651.846.1329 to reserve your space at a orientation.

Course	Cr/HR
<input type="checkbox"/> CHSN 1598 Body Systems & Diseases on-line	4/80
<input type="checkbox"/> CHSN 1599 Preclinic Introduction Online COSM	4/80
<input type="checkbox"/> COSM 1603 Preclinic Nail Care	3/80
<input type="checkbox"/> COSM 1908 Clinic 1 for Nail Technicians	3/96
<input type="checkbox"/> COSM 1952 Salon Operations 2 for Cosmetology/Nail Technician Majors	2/64
Total Program Credits 16/400	
<input type="checkbox"/> Select from the following electives as needed: CHSN 1951 Salon Operations 1 for Cosmetology/Nail Technician Majors	1
CHSN 1953 Salon Operations 3 for Cosmetology/Nail Technician Majors	3

Program Start Dates

Summer, Fall, Spring

Course Sequence

This certificate can be completed in one semester as shown in the following sequence.

First Semester

CHSN 1598 Body Systems & Diseases	4
CHSN 1599 Preclinic Introduction	4
COSM 1603 Preclinic Nail Care	3
COSM 1908 Clinic 1 for Nail Technicians	3
COSM 1952 Salon Operations 2 for Cosmetology/Nail Technician Majors	2
Total Semester Credits	16

Total Program Credits 16

Additional Requirements

Be prepared to purchase kits the first day of class from the book store with the instructor. Financial aid must have been completed.

All books **MUST** be purchased before classes begin.

Cosmetology Student Handbook/ Agreement Form

All new and returning students will need to access D2L Brightspace PRIOR to the first day of classes to read the Cosmetology student handbook. After you have read the handbook, you must print and sign: Student Agreement Form, Hepatitis B Vaccination/Declination Form and Rollabout Form and return them to your instructor on the first day of class before you will be admitted to class. You will need to perform this task prior to the first day of each semester. Please direct questions to the assigned instructor of your first class.

*Information is subject to change.
This Program Requirements Guide is not a contract.*

Minimum Program Entry Requirements

Students entering this program must meet the following minimum program entry requirements:

Reading: Score of 38+

Arithmetic: Score of 20+

Assessment Results and Prerequisites:

Students admitted into Saint Paul College programs may need to complete additional courses based on assessment results and course prerequisite requirements. Certain MATH, READ, and ENGL courses have additional prerequisites.

057C (7078)

Culinary Arts AAS DEGREE

Program Overview

The Culinary Arts AAS degree prepares individuals for career opportunities in hotels restaurants, clubs and institutional food service facilities. Responsibilities may include menu planning, purchasing food, equipment, and supplies, selecting, and developing recipes, selecting and using various food preparation methods and techniques. Management duties may include, but are not limited to financial planning, hiring, training and supervising employees. Graduates will be eligible for Certified Culinerian award from the American Culinary Federation as well as more advanced certificates with requisite culinary industry work experience.

Career Opportunities

According to the U.S. Bureau of Labor Statistics and the National Restaurant Association, meal preparation continues to shift out of the home, providing plentiful opportunities for chefs, cooks, and other food service workers. Americans spend more than \$300 billion each year on meals eaten outside the home. The service industry currently employs 9,631,900 individuals and is projected to swell by 7.7% by 2018.

Opportunities are available in hotels, restaurants, resorts, clubs, catering and corporate dining, government and school kitchens. Institutional opportunities include health care, schools, corporations, and government facilities. Culinary Arts careers can lead in many different directions such as hospitality management, sales, product development, or owning your own business.

Program Outcomes

1. Graduates will have knowledge and skills in culinary arts.
2. Graduates will demonstrate knowledge and skills in restaurant operations.
3. Graduates will be experienced in food preparation and presentation for business and industry.
4. Graduates will be prepared for immediate employment in the food service industry.
5. Graduates will have mastered the general education program requirements for work and life roles.
6. Graduates will be eligible for Minnesota Food Manager Certification.
7. Graduates will be eligible for certification by ACF as a "Certified Culinerian."
8. Graduates will create a professional career plan.
9. Graduates will apply analysis and problem solving to food production.

Program Faculty

Sean Jones sean.jones@saintpaul.edu
 Nathan Sartain nathan.sartain@saintpaul.edu

Textbook and Supply Costs

Students should expect to spend approximately \$1,300.00 for books, uniform and culinary supplies. This cost is in addition to the cost of tuition and fees.

Program Requirements

Check off when completed

Course	Cr
<input type="checkbox"/> CULA 1405 Culinary Arts Foundations 1	.2*
<input type="checkbox"/> CULA 1415 Culinary Arts Foundations 2	.4*
<input type="checkbox"/> CULA 1425 Fundamentals of Pastry	.1*
<input type="checkbox"/> CULA 1435 Butchery and Charcuterie	.2*
<input type="checkbox"/> CULA 1445 Food Service Practicum	2
<input type="checkbox"/> CULA 1455 Food Safety and Sanitation	2
<input type="checkbox"/> CULA 1465 Culinary Nutrition Theory	2
<input type="checkbox"/> CULA 1505 Contemporary Bake Shop Production	.2*
<input type="checkbox"/> CULA 1515 Contemporary Pantry Production	.2*
<input type="checkbox"/> CULA 1525 Contemporary Range Production	.2*
<input type="checkbox"/> CULA 1545 Contemporary Quick Fare Production	.2*
<input type="checkbox"/> CULA 1555 Culinary Career Portfolio	1
<input type="checkbox"/> CULA 1565 Principles of Culinary Leadership	2
<input type="checkbox"/> CULA 1575 Artisan Baking and Pastry	.2*
<input type="checkbox"/> CULA 1585 Introduction to Dining Room Service	1
<input type="checkbox"/> CULA 1590 Café Dining Practicum	2
<input type="checkbox"/> CULA 1700 Culinary Externship	3
<input type="checkbox"/> CULA 1705 Sustainable Foods Practicum	1
<input type="checkbox"/> CULA 2100 Menu Composition and Analysis	2
<input type="checkbox"/> CULA 2105 Applied Restaurant Operations 1	.3*
<input type="checkbox"/> CULA 2110 Applied Restaurant Operations 2	.3*
<input type="checkbox"/> CULA 2115 Contemporary Dining Room Service	1
<input type="checkbox"/> CULA 2220 Sensory Evaluation & Wine Pairing	.2*
<input type="checkbox"/> CULA 2225 Garde Manger	.1*
<input type="checkbox"/> CULA 2230 Food, Beverage, Labor Cost Control	3
<input type="checkbox"/> CULA 2235 Event Based Dining Capstone	2
Subtotal	52

*Information is subject to change.
 This Program Requirements Guide is not a contract.*

General Education/MnTC Requirements Cr

Refer to the Minnesota Transfer Curriculum Course List for each Goal Area

- Goal 1: Communication 7
 ENGL 1711 Composition 1 – 4 cr
 COMM 17XX COMM 1720 Interpersonal Communication – 3 cr (recommended)

Must be completed prior to starting 3rd Semester.

- Goal 3 or Goal 4 3
 Goal 3: Natural Sciences
 OR Goal 4: Mathematical/Logical Reasoning
 - Goal 5: History, Social Science and Behavioral Sciences. 3
 - Goal 6: Humanities and Fine Arts 3
- General Education Requirements 16**

Total Program Credits 68

*Course has a differential tuition rate. Check the Course Schedule at saintpaul.edu/CourseSchedule for current course costs.

Course Sequence

The course sequence listed on the back of this guide is recommended for a full-time student; however, this sequence is not required. Contact Program Faculty with questions.

*See back of this guide for
 Course Sequence & Transfer Opportunities*

Minimum Program Entry Requirements

Students entering this program must meet the following minimum program entry requirements:

Reading: Score of 60+ or grade of "C" or better in READ 0721

Writing: Score of 60+ or grade of "C" or better in ENGL 0921

Arithmetic: Score of 52+

Assessment Results and Prerequisites: Students admitted into Saint Paul College programs may need to complete additional courses based on assessment results and course prerequisite requirements. Certain MATH, READ, and ENGL courses have additional prerequisites.

183A 58PA (7114)

Culinary Arts AAS DEGREE *(continued)*

Program Start Dates

Fall, Spring, Summer – only General Education courses

Course Sequence

The course sequence listed on the back is required for a full-time student.

Accreditation

This program is accredited by the American Culinary Federation Education Foundation's Accrediting Commission. (ACFEF)

The following sequence is required for a full-time student starting in Fall semester.

First Semester

CULA 1405 Culinary Arts Foundations 1	2
CULA 1415 Culinary Arts Foundations 2	4
CULA 1425 Fundamentals of Pastry	1
CULA 1435 Butchery and Charcuterie	2
CULA 1445 Food Service Practicum	2
CULA 1455 Food Safety and Sanitation	2
CULA 1465 Culinary Nutrition Theory	2
Goal 1: COMM 17XX	3
COMM 1720 Interpersonal Communication (recommended). Must be completed prior to starting third semester coursework	
Total Semester Credits.	18

Second Semester

CULA 1505 Contemporary Bake Shop Production	2
CULA 1515 Contemporary Pantry Production	2
CULA 1525 Contemporary Range Production	2
CULA 1545 Contemporary Quick Fare Production	2
CULA 1555 Culinary Career Portfolio	1
CULA 1565 Principles of Culinary Leadership	2
CULA 1575 Artisan Baking and Pastry	2
CULA 1585 Introduction to Dining Room Service	1
CULA 1590 Café Dining Practicum	2
Goal 6: Humanities and Fine Arts	3
Total Semester Credits.	19

Third Semester (Summer)

CULA 1700 Culinary Externship	3
CULA 1705 Sustainable Foods Practicum	1
Goal 1: ENGL 1711 Composition 1	4
Goal 3 or 4: Natural Sciences or Mathematical/ Logical Reasoning	3
Total Semester Credits.	11

Fourth Semester

CULA 2100 Menu Composition and Analysis	2
CULA 2105 Applied Restaurant Operations 1	3
CULA 2110 Applied Restaurant Operations 2	3
CULA 2115 Contemporary Dining Room Service	1
CULA 2220 Sensory Evaluation & Wine Pairing	2
CULA 2225 Garde Manger	1
CULA 2230 Food, Beverage, Labor Cost Control	3
CULA 2235 Event Based dining Capstone	2
Goal 5: History, Social Sciences and Behavioral Sciences	3
Total Semester Credits.	20

Total Program Credits 68

Transfer Opportunities

Saint Paul College has a transfer articulation agreement between the following program and post-secondary institution for the baccalaureate degree program listed below.

For more information please go to www.saintpaul.edu/Transfer.

Culinary Arts AAS

BA	Individualized Studies Metropolitan State University
BS	Culinology Southwest Minnesota State University

EXEMPLARY STATUS



Saint Paul College's Culinary Arts AAS degree and Culinary Arts Diploma programs are the only exemplary culinary programs in public education in Minnesota.

Exemplary Programs symbolize the highest educational standards recognized by the American Culinary Federation Education Foundation Accrediting Commission (ACFEFAC). The award is presented to programs that have proven full compliance with all ACFEFAC accreditation requirements in the last visiting team report along with excellent management of the program.



Programmatic Accreditation by ACFEF Accrediting Commission

Culinary Arts DIPLOMA

Program Overview

The Culinary Arts Diploma prepares individuals for career opportunities in hotels, restaurants, clubs and institutional food service facilities. Responsibilities may include menu planning, purchasing food, equipment, and supplies, selecting, and developing recipes, selecting and using various food preparation methods and techniques. Management duties may include, but are not limited to financial planning, hiring, training and supervising employees.

Career Opportunities

According to the U.S. Bureau of Labor Statistics and the National Restaurant Association, meal preparation continues to shift out of the home, providing plentiful opportunities for chefs, cooks, and other food service workers. Americans spend more than \$300 billion each year on meals eaten outside the home. The service industry currently employs 9,631,900 individuals and is projected to swell by 7.7% by 2018.

Opportunities are available in hotels, restaurants, resorts, clubs, catering and corporate dining, government and school kitchens. Institutional opportunities include health care, schools, corporations, and government facilities. Culinary Arts careers can lead in many different directions such as hospitality management, sales, product development, or owning your own business.

Program Outcomes

1. Graduates will have knowledge and skills in culinary arts.
2. Graduates will demonstrate knowledge and skills in restaurant operations.
3. Graduates will be experienced in food preparation and presentation for business and industry.
4. Graduates will be prepared for immediate employment in the food service industry.
5. Graduates may be eligible for Minnesota Food Manager Certification.
6. Graduates will create a professional career plan.
7. Graduates will apply analysis and problem solving to food production.

Program Faculty

Sean Jones sean.jones@saintpaul.edu
 Nathan Sartain nathan.sartain@saintpaul.edu

Textbook and Supply Costs

Students should expect to spend approximately \$1,300.00 for books, uniform, and culinary supplies. This cost is in addition to the cost of tuition and fees.

Program Requirements

Check off when completed

Course	Cr
<input type="checkbox"/> CULA 1405 Culinary Arts Foundations 1	2*
<input type="checkbox"/> CULA 1415 Culinary Arts Foundations 2	4*
<input type="checkbox"/> CULA 1425 Fundamentals of Pastry	1*
<input type="checkbox"/> CULA 1435 Butchery and Charcuterie	2*
<input type="checkbox"/> CULA 1445 Food Service Practicum	2
<input type="checkbox"/> CULA 1455 Food Safety and Sanitation	2
<input type="checkbox"/> CULA 1465 Culinary Nutrition Theory	2
<input type="checkbox"/> CULA 1505 Contemporary Bake Shop Production	2*
<input type="checkbox"/> CULA 1515 Contemporary Pantry Production	2*
<input type="checkbox"/> CULA 1525 Contemporary Range Production	2*
<input type="checkbox"/> CULA 1545 Contemporary Quick Fare Production	2*
<input type="checkbox"/> CULA 1555 Culinary Career Portfolio	1
<input type="checkbox"/> CULA 1565 Principles of Culinary Leadership	2
<input type="checkbox"/> CULA 1575 Artisan Baking and Pastry	2*
<input type="checkbox"/> CULA 1585 Introduction to Dining Room Service	1
<input type="checkbox"/> CULA 1590 Café Dining Practicum	2
<input type="checkbox"/> CULA 1700 Culinary Externship	3
<input type="checkbox"/> CULA 1705 Sustainable Foods Practicum	1
<input type="checkbox"/> CULA 2100 Menu Composition and Analysis	2
<input type="checkbox"/> CULA 2105 Applied Restaurant Operations 1	3*
<input type="checkbox"/> CULA 2110 Applied Restaurant Operations 2	3*
<input type="checkbox"/> CULA 2115 Contemporary Dining Room Service	1
<input type="checkbox"/> CULA 2220 Sensory Evaluation & Wine Pairing	2*
<input type="checkbox"/> CULA 2225 Garde Manger	1*
<input type="checkbox"/> CULA 2230 Food, Beverage, Labor Cost Control	3
<input type="checkbox"/> CULA 2235 Event Based Dining Capstone	2
Subtotal	52

*Information is subject to change.
 This Program Requirements Guide is not a contract.*

General Education/MnTC Requirements Cr

Refer to the Minnesota Transfer Curriculum Course List for each Goal Area

- Goal 1: Communication 3
 COMM 17XX COMM 1720 Interpersonal Communication – 3 cr (recommended)
- Goal 3 or Goal 4 3
 Goal 3: Natural Sciences
 OR Goal 4: Mathematical/Logical Reasoning
- General Education Requirements 6**

Total Program Credits 58

*Course has a differential tuition rate. Check the Course Schedule at saintpaul.edu/CourseSchedule for current course costs.

Course Sequence

The course sequence listed on the back of this guide is recommended for a full-time student; however, this sequence is not required. Contact Program Faculty with questions.

See back of this guide for Course Sequence

Minimum Program Entry Requirements

Students entering this program must meet the following minimum program entry requirements:

Reading: Score of 60+ on Reading Comprehension or grade of "C" or better in READ 0721

Writing: Score of 60+ or grade of "C" or better in ENGL 0921

Arithmetic: Score of 52+

Assessment Results and Prerequisites: Students admitted into Saint Paul College programs may need to complete additional courses based on assessment results and course prerequisite requirements. Certain MATH, READ, and ENGL courses have additional prerequisites.

058D 58PD (7013)

Culinary Arts DIPLOMA *(continued)*

Program Start Dates

Fall, Spring, Summer – only General Education courses

Course Sequence

The course sequence listed on the back is required for a full-time student.

Accreditation

This program is accredited by the American Culinary Federation Education Foundation's Accrediting Commission. (ACFEF)

The following sequence is required for a full-time student starting in Fall semester.

First Semester

CULA 1405 Culinary Arts Foundations 1	2
CULA 1415 Culinary Arts Foundations 2	4
CULA 1425 Fundamentals of Pastry	1
CULA 1435 Butchery and Charcuterie	2
CULA 1445 Food Service Practicum	2
CULA 1455 Food Safety and Sanitation	2
CULA 1465 Culinary Nutrition Theory	2
Goal 1: COMM 17XX	3
COMM 1720 Interpersonal Communication (recommended). Must be completed prior to starting third semester coursework	
Total Semester Credits.	18

Second Semester

CULA 1505 Contemporary Bake Shop Production	2
CULA 1515 Contemporary Pantry Production	2
CULA 1525 Contemporary Range Production	2
CULA 1545 Contemporary Quick Fare Production	2
CULA 1555 Culinary Career Portfolio	1
CULA 1565 Principles of Culinary Leadership	2
CULA 1575 Artisan Baking and Pastry	2
CULA 1585 Introduction to Dining Room Service	1
CULA 1590 Café Dining Practicum	2
Total Semester Credits.	16

Third Semester (Summer)

CULA 1700 Culinary Externship	3
CULA 1705 Sustainable Foods Practicum	1
Goal 3 or 4: Natural Sciences or Mathematical/ Logical Reasoning	3
Total Semester Credits.	7

Fourth Semester

CULA 2100 Menu Composition and Analysis	2
CULA 2105 Applied Restaurant Operations 1	3
CULA 2110 Applied Restaurant Operations 2	3
CULA 2115 Contemporary Dining Room Service	1
CULA 2220 Sensory Evaluation & Wine Pairing	2
CULA 2225 Garde Manger	1
CULA 2230 Food, Beverage, Labor Cost Control	3
CULA 2235 Event Based dining Capstone	2
Total Semester Credits.	17
Total Program Credits	58

EXEMPLARY STATUS



Saint Paul College's Culinary Arts AAS degree and Culinary Arts Diploma programs are the only exemplary culinary programs in public education in Minnesota.

Exemplary Programs symbolize the highest educational standards recognized by the American Culinary Federation Education Foundation Accrediting Commission (ACFEFAC). The award is presented to programs that have proven full compliance with all ACFEFAC accreditation requirements in the last visiting team report along with excellent management of the program.



Programmatic Accreditation by ACFEF Accrediting Commission

Culinary Foundations CERTIFICATE

Program Overview

Graduates will have completed training in cooking, baking, and pastry fundamentals, learning techniques in the production of various hot and cold foods as well as butchery.

Graduates will be prepared for positions in casual dining, quick service, cafeteria, healthcare institutional/commercial foods, butchery, and as pastry assistants. Course work will also provide the nutrition, sanitation, and food safety training necessary for entry level and managerial food service positions.

Career Opportunities

According to the U.S. Bureau of Labor Statistics and the National Restaurant Association, meal preparation continues to shift out of the home, providing plentiful opportunities for chefs, cooks, and other food service workers. Americans spend more than \$300 billion each year on meals eaten outside the home. The service industry currently employs 9,631,900 individuals and is projected to swell by 7.7% by 2018.

Opportunities are available in restaurants, catering/corporate dining, government and school kitchens Institutional opportunities include health care, schools, corporations, and government facilities. Pastry assistant positions are available in hotels, casinos, private clubs, and resorts.

Program Outcomes

1. Graduates will have knowledge and skills in restaurant production line service and commercial food operations.
2. Graduates will demonstrate knowledge of pastry, hot and cold food preparations 3. Graduates will be prepared for immediate employment in the food service industry.
4. Graduates will demonstrate knowledge of culinary nutrition as applied to all facets of the food service and hospitality industry.
5. Graduates will have demonstrated and applied proper sanitation, food and kitchen safety
6. Graduates will be eligible for ServSafe Certification and Minnesota Food Manager Certification.

Program Faculty

Sean Jones sean.jones@saintpaul.edu
 Nathan Sartain nathan.sartain@saintpaul.edu

Textbook and Supply Costs

Students should expect to spend approximately \$1,000.00 for books, uniform, and culinary supplies. This cost is in addition to the cost of tuition and fees.

Program Requirements

Check off when completed

Course	Cr
<input type="checkbox"/> CULA 1405 Culinary Arts Foundations 1	2*
<input type="checkbox"/> CULA 1415 Culinary Arts Foundations 2	4*
<input type="checkbox"/> CULA 1425 Fundamentals of Pastry	1*
<input type="checkbox"/> CULA 1435 Butchery and Charcuterie	2*
<input type="checkbox"/> CULA 1445 Food Service Practicum	2
<input type="checkbox"/> CULA 1455 Food Safety and Sanitation	2
<input type="checkbox"/> CULA 1465 Culinary Nutrition Theory	2
Subtotal	15

General Education/MnTC Requirements

Refer to the Minnesota Transfer Curriculum Course List for each Goal Area

<input type="checkbox"/> Goal 3 or Goal 4	3
Goal 3: Natural Sciences – 3 cr	
OR Goal 4: Mathematical /Logical Reasoning – 3 cr	
General Education Requirements	3

Total Program Credits

*Course has a differential tuition rate. Check the Course Schedule at saintpaul.edu/CourseSchedule for current course costs.

Program Start Dates

Fall, Spring

Course Sequence

The following sequence is recommended; however, this sequence is not required.

First Semester

CULA 1405 Culinary Arts Foundations 1	2
CULA 1415 Culinary Arts Foundations 2	4
CULA 1425 Fundamentals of Pastry	1
CULA 1435 Butchery and Charcuterie	2
CULA 1445 Food Service Practicum	2
CULA 1455 Food Safety and Sanitation	2
CULA 1465 Culinary Nutrition Theory	2
Goal 3 or 4: Natural Sciences or Mathematical/ Logical Reasoning	3
Total Semester Credits	18

Total Program Credits

18

Minimum Program Entry Requirements

Students entering this program must meet the following minimum program entry requirements:

Reading: Score of 60+ on Reading Comprehension or grade of "C" or better in READ 0721

Writing: Any

Arithmetic: Score of 52+

Assessment Results and Prerequisites:

Students admitted into Saint Paul College programs may need to complete additional courses based on assessment results and course prerequisite requirements. Certain MATH, READ, and ENGL courses have additional prerequisites.

371C (7208)

*Information is subject to change.
 This Program Requirements Guide is not a contract.*

Pastry and Baking CERTIFICATE

Program Overview

Chefs and cooks prepare a variety of foods in many different environments, from preparation of a la carte (prepared to order) to banquets for hundreds of people. Responsibilities include sanitation, maintaining an accounting and inventory control system, estimating the amount of food needed, purchasing food supplies, and planning menus. Nutritional aspects of healthy cooking are increasingly incorporated into the chefs menu.

This certificate will allow the student to gain sufficient knowledge and skill to become employable in a commercial baking and cake decorating environment. Bakeries, pastry shops and candy shops are potential employers. Many large department stores, grocery stores, hotels and private clubs also hire our graduates. Entrepreneurs that are interested in having these skills to support their own plan are also welcome.

A good general education, good reading ability, and a working knowledge of mathematics is important so that students can interpret weights and measures, calculate recipes, and understand cost control, inventory control and forecasting.

Career Opportunities

According to the U.S. Bureau of Labor Statistics and the National Restaurant Association, meal preparation continues to shift out of the home, providing plentiful opportunities for chefs, cooks, and other food service workers. Americans spend more than \$300 billion each year on meals eaten outside the home. The service industry currently employs 9,631,900 individuals and is projected to swell by 7.7% by 2018.

Opportunities are available in hotels, restaurants, resorts, clubs, catering and corporate dining, government and school kitchens. Institutional opportunities include health care, schools, corporations, and government facilities. Culinary Arts careers can lead in many different directions such as hospitality management, sales, product development, or owning your own business.

Program Outcomes

1. Graduates will be proficient in the preparation of various cakes, pastries and icings.
2. Graduates will demonstrate skilled use of piping bag and decorating technique.
3. Graduates will be eligible for Minnesota Food Manager Certification.
4. Graduates will be prepared for immediate employment in bakery.

Program Faculty

Sean Jones sean.jones@saintpaul.edu
 Nathan Sartain nathan.sartain@saintpaul.edu

Professional Focus

This program offers a focused, hands-on, professional approach to baking breads, cakes and pastries, including development of marketable cake decorating skills.

Transferable Credits

The majority of credits completed in the Pastry and Baking Certificate program apply to the Culinary Arts Diploma and AAS Degree programs.

Textbook and Supply Costs

Students should expect to spend approximately \$400.00 for books, uniform, and culinary supplies. This cost is in addition to the cost of tuition and fees.

Program Requirements

Check off when completed

Course	Cr
<input type="checkbox"/> CULA 1405 Culinary Arts Foundations 1	2*
<input type="checkbox"/> CULA 1425 Fundamentals of Pastry	1*
<input type="checkbox"/> CULA 1455 Food Safety and Sanitation	2
<input type="checkbox"/> CULA 1465 Culinary Nutrition Theory	2
<input type="checkbox"/> CULA 1565 Principles of Culinary Leadership	2
<input type="checkbox"/> CULA 1575 Artisan Baking and Pastry	2*
<input type="checkbox"/> CULA 2600 Advanced Decorating and Pastry	3
<input type="checkbox"/> CULA 2610 Showpieces and Coniserie	3

Total Program Credits 17

*Course has a differential tuition rate. Check the Course Schedule at saintpaul.edu/CourseSchedule for current course costs.

*Information is subject to change.
 This Program Requirements Guide is not a contract.*

Program Start Dates

Fall, Spring

Course Sequence

This certificate can be completed in a variety of ways. Courses may be offered in the day or evening.

First Semester (Fall)

CULA 1425 Fundamentals of Pastry	1*
CULA 1455 Food Safety and Sanitation	2
CULA 1465 Culinary Nutrition Theory	2
CULA 1565 Principles of Culinary Leadership	2
Total Semester Credits	7

Second Semester

(Spring, Afternoon Section)

CULA 1405 Culinary Arts Foundations 1	2*
CULA 1575 Artisan Baking and Pastry	2*
CULA 2600 Advanced Decorating and Pastry	3
CULA 2610 Showpieces and Coniserie	3
Total Semester Credits	10

Total Program Credits 17

Minimum Program Entry Requirements

Students entering this program must meet the following minimum program entry requirements:

Reading: Score of 60+ on Reading Comprehension or grade of "C" or better in READ 0721

Writing: Any

Arithmetic: Score of 52+

Assessment Results and Prerequisites:

Students admitted into Saint Paul College programs may need to complete additional courses based on assessment results and course prerequisite requirements. Certain MATH, READ, and ENGL courses have additional prerequisites.

376C

Wine Professional CERTIFICATE

Program Overview

The Wine Professional Certificate provides the graduate with a strong knowledge of wine, wine service skills, and wine marketing strategies.

Career Opportunities

The wine industry is rapidly expanding within the United States, where wine sales represent the largest wine consumer market in the world. A new report published by Allied Market Research, titled, "Luxury Wines and Spirits Market by Product Type, Distribution Channel and Geography: Global Opportunity Analysis and Industry Forecast, 2014 - 2022," projects that the global luxury wines and spirits market was valued at \$812,108 million in 2015, and is expected to reach \$1,122,578 million by 2022, growing at a CAGR of 4.8 percent from 2016 to 2022. Wine sales have now surpassed beer sales, with millennials rapidly adapting to wine over beer. Wine sales are an important profit center for the restaurant/ hospitality industry, and thus a comprehensive knowledge of wine is critical for maximizing outcomes.

Opportunities are available in hotels, restaurants, resorts, clubs, catering and corporate dining.

Graduates of the Wine Professional Certificate will be prepared for careers in the restaurant/ hospitality industry, wine distribution, and wholesale/retail wine trade.

Source: Modern Restaurant Management, Top 5 Consumer Trends of 2017, 2017 Edition

Program Outcomes

1. Graduates will have knowledge and skills in professional tasting techniques for assessment and evaluation of wine.
2. Graduates will have knowledge and skills in wine service techniques.
3. Graduates will have knowledge and skills in wine business considerations.
4. Graduates will have knowledge and skills in wine merchandising, marketing and public relations.

Program Faculty

Nikki Erpelding nikki.erpelding@saintpaul.edu

Program Requirements

Check off when completed

- All credits must be completed in one semester.
- Must be 21 years of age**

Course	Cr
<input type="checkbox"/> WINE 1600 Professional Introduction to Wine	2
<input type="checkbox"/> WINE 1610 Flavor Dynamics of Wine.	2*
<input type="checkbox"/> WINE 1620 Professional Wine Service**	1**
<input type="checkbox"/> WINE 1630 Strategies for Pairing Food and Wine	2
<input type="checkbox"/> WINE 1640 Wine Marketing	2
Total Program Credits	9

*Course has a differential tuition rate. Check the Course Schedule at saintpaul.edu/CourseSchedule for current course costs.

**Alcohol awareness/server training is part of WINE 1620

Program Start Dates

Fall

Course Sequence

The following sequence is required.

- All courses must be completed within the same semester.
- Program is not eligible for financial aid.

One Semester

WINE 1600 Professional Introduction to Wine	2
WINE 1610 Flavor Dynamics of Wine	2
WINE 1620 Professional Wine Service	1
WINE 1630 Strategies for Pairing Food and Wine	2
WINE 1640 Wine Marketing	2
Total Semester Credits.	9

Total Program Credits 9

*Information is subject to change.
This Program Requirements Guide is not a contract.*

Minimum Program Entry Requirements
Students entering this program must meet the following minimum program entry requirements:
Must be 21 years of age.

236C

Sign Language Interpreter/Transliterator AAS DEGREE

Program Overview

The Sign Language Interpreter/Transliterator AAS Degree program prepares individuals to work as interpreter transliterators facilitating and mediating communication between Deaf/Hard of Hearing/Deaf-Blind and hearing people. Interpreters must convey accurate messages, feelings and attitudes of participants, whether those messages are spoken or signed. To accomplish this, competency in English and in American Sign Language are necessary. A strong academic background, traits that demonstrate maturity, responsibility, flexibility, and the ability to work well under pressure, are assets.

The curriculum requires both general education courses as well as courses specifically related to the Deaf Community and interpreting. The program covers a variety of subject areas which include: ASL linguistics and language development, interpreting process theory and application, interpreter roles/responsibilities, interpreter's Code of Professional Conduct, history of deaf people and their culture, and the historical evolution of the interpreting profession. Interpreting and Transliterating skills courses provide guided practice in developing the skills necessary to effectively interpret/transliterate. Students will experience a variety of learning environments including classroom work, laboratory practice and field placement. Students will be required to have both in-class and out-of-class experiences with members of the Deaf Community to further develop ASL fluency and cultural awareness.

Career Opportunities

Graduates will be qualified for careers as entry-level sign language interpreters with social service agencies, educational programs, community-based settings, or recreational situations. The employment outlook, due to accessibility legislation, has increased the need for interpreters.

Graduates will have opportunities to further their education and to specialize in their work through professional affiliations or by obtaining national certification. Graduates who plan to work in K-12 educational settings must hold a Provisional Certificate which allows them to become a practitioner for a maximum of two years or until they obtain national certification.

Program Outcomes

1. Graduates will have an understanding and knowledge about the theoretical, ethical, and practical foundations of the interpreting field needed to pass the NAD-RID National Interpreter Certification (NIC) written test
2. Graduates will have the knowledge and skills to interpret between American Sign Language and English.
3. Graduates will have the knowledge and skills to transliterate between spoken

- English and a signed form of English.
4. Graduates will have the knowledge and skills to function as cross-cultural mediators in order to transmit and transfer culturally-based linguistic and non-linguistic information.
5. Graduates will be informed of the necessary employment knowledge, and professional behaviors that are requisite for employment as Sign Language Interpreters/Transliterators.
6. Graduates will sit for national certification within two years of graduation.

Program Faculty

Linda Gill linda.gill@saintpaul.edu

Special Features

The Sign Language Interpreter/Transliterator Program is one of the original six interpreter programs in the United States. It was established in 1972.

Program Requirements

Check off when completed

Program Prerequisites

- ASLS 1411 American Sign Language 1 (3 cr)
with a grade of "C" or better
- ASLS 1412 American Sign Language 2 (3 cr)
with a grade of "C" or better
- ASLS 1413 American Sign Language 3 (3 cr)
with a combined GPA of 3.0 in ASL 3 & ASL 4
- ASLS 1414 American Sign Language 4 (3 cr)
with a combined GPA of 3.0 in ASL 3 & ASL 4

Pre-Core Program General Education Courses

Prior to Official Acceptance into Program Cr

In addition to completing the Program Prerequisites above, the following two General Education courses must be completed, or in progress with, a "C" or better grade prior to submitting your Program Major Application called the Application to Sign Language Interpreter/Transliterator AAS Degree Major form.

- Goal 1: ENGL 1711 Composition 1 4
- Goal 5: PSYC 1720 Psychology Throughout the Lifespan preferred 3
(PSYC 1710 General Psychology accepted)
- Pre-Core General Education Requirements 7**

Core Courses Cr

The following Core courses can only be taken after official acceptance into the Sign Language Interpreter/Transliterator program.

- ASLS 1420 ASL Linguistics 4
- ASLS 1430 Classifiers 3
- ASLS 1435 Deaf Studies/Culture 3
- INTP 1440 Orientation to Interpreting 3
- INTP 1442 English Grammar for Sign Language Interpreters 2

- INTP 1500 Interpreting Process 2
- INTP 1512 Consecutive Interpreting 1 4
- INTP 1513 Consecutive Interpreting 2 2
- INTP 2411 Sign to Voice Interpreting 1 4
- INTP 2412 Sign to Voice Interpreting 2 2
- INTP 2421 Voice to Sign Interpreting 1 4
- INTP 2422 Voice to Sign Interpreting 2 2
- INTP 2431 Transliterating 1 4
- INTP 2432 Transliterating 2 2
- INTP 2585 Internship Orientation 1
- INTP 2592 Interpreter Internship 5
- Technical Electives 4

2 credits may be taken from the following electives:

- ASLS 1415 American Sign Language 5 3
- ASLS 1443 ASL Fingerspelling and Numbers 3
- ASLS 1446 ASL Non-Manual Markers 2
- ASLS 1450 American Sign Language Semantics 3
- INTP 1465 Special Topics: Interpreting 1-5

2 credits must be taken from the following electives:

- INTP 2410 Video Relay/Video Remote Interpreting 2
- OR
- INTP 2450 Deaf/Blind Interpreting 2
- Core Credits 51**

Remaining General Education/
MnTC Requirements Cr

Must complete at least 9 remaining credits from the Minnesota Transfer Curriculum (MnTC)

- Goal 1: Communication 3
COMM 17XX – 3 cr
- Goal 3 or Goal 4 3
Goal 3: Natural Sciences
OR Goal 4: Mathematical/Logical Reasoning
- Goal 6: Humanities and Fine Arts 3
- Remaining General Education Requirements 9**
- Core Credits 51**
- Pre-Core General Education Requirements 7**

Total Program Credits 67

Program Start Dates

Fall

Course Sequence

The course sequence listed on the back of this guide is recommended but not required. Contact Program Faculty with questions.

*See back of this guide for
Course Sequence and Transfer Opportunities*

*Information is subject to change.
This Program Requirements Guide is not a contract.*

Sign Language Interpreter/Transliterator AAS DEGREE *(continued)*

Course Sequence

The following sequence is recommended for a full-time student. Students are encouraged to take a portion of their general education requirements in the summer term during their program in order to lessen their academic load during the school year.

Part-time day courses are available during the fall and spring of the first year of the 2-year program. The summer course between first and second year is day programming. The second year of the program must be taken full-time, days. Not all courses are offered each semester; a selection of courses are offered summer term.

Required General Education Courses to be taken prior, or in progress, to submitting Program Major Application:

- Goal 1: ENGL 1711 Composition 1 4
- Goal 5: PSYC 1720 Psychology Throughout the Lifespan preferred. 3
(PSYC 1710 General Psychology accepted)

Any Semester prior to Program Acceptance 7
With Official Acceptance into the Program, students begin taking INTP/ASLS Core Courses as follows:

First Semester

- ASLS 1420 ASL Linguistics 4
must be taken concurrently with or previous to INTP 1500 and INTP 1442
- ASLS 1435 Deaf Studies/Culture. 3
can be taken concurrently with ASL 1-4
- INTP 1442 English Grammar for Sign Language Interpreters 2
must be taken concurrently with or previous to ASLS 1420 and INTP 1500
- INTP 1500 Interpreting Process 2
must be taken concurrently with ASLS 1420 and INTP 1442
- Goal 1: COMM 17XX 3
- Total Semester Credits. 14**

Second Semester

- ASLS 1430 Classifiers 3
- INTP 1440 Orientation to Interpreting 3
- INTP 1512 Consecutive Interpreting 1 4
Goal 3: Natural Sciences
OR Goal 4: Mathematical/Logical Reasoning. . . . 3
- Total Semester Credits. 13**

Third Term

- INTP 1513 Consecutive Interpreting 2 2
- Technical Electives. 2
- Goal 6: Humanities and Fine Arts. 3
- Total Semester Credits. 7**

Fourth Semester

- INTP 2411 Sign to Voice Interpreting 1 4
- INTP 2421 Voice to Sign Interpreting 1 4
- INTP 2431 Transliterating 1. 4
- INTP 2585 Internship Orientation. 1
- Total Semester Credits. 13**

Fifth Semester

- INTP 2412 Sign to Voice Interpreting 2 2
- INTP 2422 Voice to Sign Interpreting 2 2
- INTP 2432 Transliterating 2. 2
- INTP 2592 Interpreter Internship 5
- Technical Electives. 2
- Total Semester Credits. 13**

Total Program Credits 67

All INTP core courses as well as ASLS courses require a grade of "C" or better.

Program-Specific Admission Process

The Sign Language Interpreter/Transliterator program has a program-specific admission process.

Admission requirements include completing the following course work before submitting the Program Major Application:

- American Sign Language 1 with a "C" or better
- American Sign Language 2 with a "C" or better
- American Sign Language 3 with a combined GPA of 3.0 in ASL 3 & ASL 4
- American Sign Language 4 with a combined GPA of 3.0 in ASL 3 & ASL 4
- ENGL 1711 Composition 1 (or equivalent) with a "C" or better
- PSYC 1720 Psychology Throughout the Lifespan preferred; PSYC 1710 General Psychology accepted. Course must be completed with a "C" or better

Program Major Application Form Submission

The Program Major Application form is called the "Application to Sign Language Interpreter/Transliterator AAS Degree Major" and is available on the program Web page. On the Program Major Application form, students verify satisfactory completion or courses in progress of the above requirements.

Above average skills on college assessment tests for reading and writing English are used to determine entry into the program.

ASL Courses must have been taken within the past five years. The last ASL course must be within the past 18 months of date of application. Applicants must ensure that all technical credits submitted for review have been received within five years of application date. Technical credits are valid for five years. This includes transfer technical credits, which are used for specific technical program requirements.

Students who have not had recent ASL courses (within the past 18 months) at date of application will need to refresh their skills by repeating their last ASL course or by taking ASL 5 during the summer term prior to beginning the Sign Language Interpreter/Transliterator Program.

The Credit by Examination/Test-Out is available for ASL 1 and ASL 2 only. Credit by Examination/Test-Out are not transferable from another educational institution.

Transfer Opportunities

Saint Paul College has a transfer articulation agreement between the following program and post-secondary institution for the baccalaureate degree program listed below.

For more information please go to saintpaul.edu/Transfer.

Sign Language Interpreter/Transliterator AAS

- BA Health Care Administration
Concordia University, St. Paul
- BA Individualized Studies
Metropolitan State University
- BS Applied Organizational Studies
Minnesota State University, Mankato
- BS Healthcare and Human Service Management
Saint Mary's University,
Twin Cities Campus

Minimum Program Entry Requirements

Complete prerequisite ASL 1 and ASL 2 with grade of "C" or better, ASL 3 and ASL 4 with a combined GPA of 3.0. Complete prerequisite of Composition 1 (ENGL 1711) and Psychology Throughout the Lifespan (PSYC 1720) preferred; General Psychology (PSYC 1710) accepted. Course must be completed with "C" grade or better.

It is necessary for students in the Sign Language Interpreter/Transliterator Program to be able to process auditory and visual information.

Reading: Score of 78+ or grade of "C" or better in READ 0722

Writing: Score of 78+ on Reading Comprehension or grade of "C" or better in ENGL 0922

Arithmetic: Score of 52+ or grade of "C" or better in MATH 0745

Assessment Results and Prerequisites: Students admitted into Saint Paul College programs may need to complete additional courses based on assessment results and course prerequisite requirements. Certain MATH, READ, and ENGL courses have additional prerequisites.

049A 624A (7056)

STEM: Science, Technology, Engineering & Mathematics Programs & Courses

Science & Mathematics

Science

Biochemistry	170
Biology	170
Chemistry	171
Natural Sciences	171
Physics	171

Mathematics

Mathematics	171
-----------------------	-----

Science, Technology and Engineering

Science

Biology Transfer Pathway AS (60 Credits)	172-173
Chemistry Transfer Pathway AS (60 Credits)	174
Science Technician AS Degree (60 Credits)	175

Engineering

Engineering Broad Field AS Degree (60 Credits)	176-177
---	---------

Computer Graphics and Visualization

Computer Graphics and Visualization AS Degree (60 Credits)	178
Visualization Technology AAS Degree (60 Credits)	179-180
Visualization Technology Certificate (21 Credits)	181
Computer Animation Certificate (18 Credits)	182
Web Design Certificate (18 Credits)	183

Computer Science

CyberSecurity AAS Degree (60 Credits)	184-185
CyberSecurity Certificate (24 Credits)	186
Computer Science Transfer Pathway AS Degree (60 Credits)	187-188
Management Information Systems AS Degree (60 Credits)	189-190
Computer Network Engineering AAS Degree (60 Credits)	191-192
Computer Programming AAS Degree (60 Credits)	193-194
Network Administration Certificate (24 Credits)	195-196
Java Programming Certificate (24 Credits)	197-198
Web Based 2D Game Development Certificate (24 Credits)	199-200
Web Development Certificate (24 Credits)	201-202

Data Science

Data Science AS Degree (60 Credits)	203
Geographic Information Science AAS Degree (60 Credits)	204
Geographic Information Science Certificate (24 Credits)	205

STEM: Science, Technology, Engineering & Mathematics Courses

Course delivery methods change on a semester basis. Please check the current course schedule for the most up-to-date information at saintpaul.edu/CourseSchedule.

Science

Biochemistry

Biochemistry is the study of the chemical reactions in living organisms, and it contains aspects of organic and inorganic chemistry as well as biology. Topics covered in biochemistry include protein structure and function, as well as cell metabolic processes that include lipids, carbohydrates, proteins, and nucleic acids. Biochemistry includes fundamental concepts that can be applied to molecular biology, immunochemistry, neurochemistry, and biophysical chemistry. It has a wide range of applications which can be applied to fields such as medicine, agriculture, toxicology, and engineering to name a few. Biochemists often work in modern research laboratories and participate in stimulating, creative work. They interact with scientists from other fields because their research is intertwined. The application of biochemistry to other fields focuses on improving the quality of life. Opportunities for employment in this field are expected to grow in industry, medicine, and genetic research.

Course	Cr
BIOC 1730 Biochemical Laboratory Exploration	4
BIOC 1790 Special Topics in Biochemistry	1-6
BIOC 2700 Biochemistry	4
BIOC 2790 Biochemistry Internship/Research Project	1-4

Biology

The Biology department provides high quality educational experiences in the biological sciences including: environmental science, general biology for majors and non-majors, nutrition, medical terminology, forensic science, biology of women, human anatomy and physiology for majors and non-majors, and microbiology. The faculty believe biology occupies a central position in the physical sciences and that an understanding of fundamental biological principles enables students to make better-informed decisions for work and life roles. The biology faculty promote active learning in lecture and lab activities, interacting closely with students at various levels of academic development. Biology courses serve the College and students by providing offerings that satisfy requirements for general education, allied health and pre-professional transfer programs. Biology faculty are committed to excellence in teaching and scholarship providing a variety of lab/field experiences and online applications.

Course	Cr
BIOL 1471 Medical Terminology	2
BIOL 1725 Environmental Science	4
BIOL 1730 Human Body Systems	3
BIOL 1735 Understanding Biology	4
BIOL 1740 General Biology 1: The Living Cell	5
BIOL 1745 General Biology 2: The Living World	5
BIOL 1760 Nutrition	3
BIOL 1782 Introduction to Forensic Science	4
BIOL 1785 Biology of Women	3
BIOL 1790 Special Topics in Biology	1-6
BIOL 2721 Human Anatomy and Physiology 1	4
BIOL 2722 Human Anatomy and Physiology 2	4
BIOL 2750 General Microbiology	4
BIOL 2755 Genetics	4
BIOL 2760 Cell and Molecular Biology	5
BIOL 2770 Biology Internship	1-4

Chemistry

The Chemistry department offers courses that provide an understanding of chemical principles across the discipline. The chemistry faculty believe that an understanding of fundamental chemical principles enables students to make better-informed decisions on a wide variety of issues related to work and life roles. The faculty interact closely with students, a diverse population at various levels of academic development, to help them develop capabilities in science and become lifelong learners. Chemistry courses fulfill requirements for general education and various graduation requirements.

Course		Cr
CHEM 1700	Chemistry Concepts	4
CHEM 1711	Principles of Chemistry 1	4
CHEM 1712	Principles of Chemistry 2	4
CHEM 2720	Organic Chemistry 1	5
CHEM 2721	Organic Chemistry 2	5
CHEM 2730	Instrumental Analysis	4
CHEM 2790	Science Technician Laboratory Research Project	1-4
CHEM 2791	Cleanroom Lab Research Project	1-4
CHEM 2795	Special Topics in Chemistry	1-6

Natural Sciences

The Natural Sciences department offers courses in the areas of earth science, geology, oceanography, and meteorology. Natural Science courses fulfill Goals 3, 9 & 10 of the Minnesota Transfer Curriculum, as well as various graduation requirements.

Course		Cr
NSCI 1710	Earth Science	4
NSCI 1721	Introduction to Geology	4
NSCI 1730	Introduction to Oceanography	3
NSCI 1740	Introduction to Meteorology	3
NSCI 1750	Natural Disasters	3
NSCI 1770	Introduction to Energy and the Environment	3
NSCI 1780	Contemporary Issues in Science	3
NSCI 1782	Minnesota Geology	3
NSCI 1790	Special Topics in Natural Science	1-6
NSCI 2770	Natural Sciences Internship	1-4

Physics

The study of Physics involves the study of matter and motion, energy and forces. The Physics department offers Principles of Physics 1 and 2 as well as General Physics 1 and 2 with a calculus base. Students enroll in physics courses to fulfill the Minnesota Transfer Curriculum requirements and various graduation requirements.

Course		Cr
PHYS 1720	Principles of Physics 1	4
PHYS 1722	Principles of Physics 2	4
PHYS 1760	Descriptive Astronomy (no lab)	3
PHYS 2700	General Physics 1 (with Calculus)	5
PHYS 2710	General Physics 2 (with Calculus)	5
PHYS 2760	Introductory Astronomy (with lab)	4
PHYS 2790	Special Topics in Physics	1-6

Mathematics

Mathematics

The study of mathematics provides foundational knowledge for understanding other disciplines, as well as logical reasoning and problem solving skills for work and life roles. The department offers a full curriculum to meet the educational needs of our students such as developmental offerings, mathematics courses specific to majors and a range of general education courses including Statistics, College Algebra, Calculus, and Ordinary Differential Equations. Courses fulfill Minnesota Transfer Curriculum requirements and graduation requirements.

Course		Cr
MATH 0910*	Introductory Algebra	3
MATH 0920*	Intermediate Algebra	3
MATH 1411*	Applied Mathematics	3
MATH 1420*	Trade Algebra and Trigonometry	3
MATH 1710	Liberal Arts Mathematics	3
MATH 1730	College Algebra	3
MATH 1740	Introduction to Statistics	4
MATH 1750	Trigonometry	3
MATH 1762	Pre-Calculus	5
MATH 1790	Special Topics in Mathematics	1-6
MATH 2100	Intermediate Statistics	4
MATH 2460	Discrete Structures of Computer Science	4
MATH 2749	Calculus 1	4
MATH 2750	Calculus 2	4
MATH 2753	Multivariable Calculus	4
MATH 2760	Differential Equations and Linear Algebra	4

* Does not meet Minnesota Transfer Curriculum (MnTC) Distribution Requirements

Biology Transfer Pathway AS DEGREE

Program Overview

The Biology Transfer Pathway AS degree is awarded for successful completion of 60 credits in science and liberal arts. It is designed to constitute the first two years of a bachelor's degree in Biology.

Career Opportunities

A biology major is a good choice for students who are intrigued by living things. Upon completion of the Biology Transfer Pathway AS degree, students will have learned to apply the scientific method, set up experiments, and use laboratory equipment. Students will develop laboratory skills, techniques, and procedures allowing them to gather, organize, and analyze data. As graduates in Biology, students can choose a number of career options from technical scientific laboratory careers to education. Salaries will vary depending on the chosen career path.

Program Outcomes

1. Implement scientific processes through experimentation, data analysis, and the use of common tools in a biology laboratory (i.e. microscope, spectrophotometer, electrophoresis).
2. Communicate scientific findings through the use of appropriate technology.
3. Describe major biological concepts and various biological systems and their interactions.
4. Apply biological concepts to contemporary issues using scientific literature and appropriate knowledge from other disciplines.
5. Collaborate with others on designing, conducting, and evaluating projects.

Program Faculty

- Anita Bansal anita.bansal@saintpaul.edu
 Joanna Cregan joanna.cregan@saintpaul.edu
 Mariann Gabrawy mariann.gabrawy@saintpaul.edu
 Jim Gielissen jim.gielissen@saintpaul.edu
 Rachel Hudson rachel.hudson@saintpaul.edu
 Nasreen Mehmood nasreen.mehmood@saintpaul.edu
 Kirstin Purcell kirstin.purcell@saintpaul.edu
 Mary Stueve mary.stueve@saintpaul.edu

Program Start Dates

Fall, Spring, Summer

Course Sequence

The course sequence listed on the back of this guide is recommended for a full-time student; however, this sequence is not required. Contact Program Faculty with questions.

See back of this guide for Course Sequence and Transfer Opportunities

Program Requirements

Check off when completed

Course	Cr
<input type="checkbox"/> BIOL 1740 General Biology 1	5
<input type="checkbox"/> BIOL 1745 General Biology 2	5
<input type="checkbox"/> BIOL 2755 Genetics	4
<input type="checkbox"/> CHEM 1711 Principles of Chemistry 1	4
<input type="checkbox"/> CHEM 1712 Principles of Chemistry 2	4
<input type="checkbox"/> Program Electives (select 1 of the following)	4-5
BIOL 2750 General Microbiology – 4 cr	
These courses can be taken at partner institutions	
BIOL 17XX Cell and Molecular Biology – 5 cr	
BIOL 17XX General Ecology – 5 cr	
Century College	
Inver Hills Community College	
Minneapolis Community & Technical College	
Normandale Community College	
Subtotal	26-27

General Education/MnTC Requirements

Refer to the Minnesota Transfer Curriculum Course List for each Goal Area

<input type="checkbox"/> Goal 1: Communication	9
ENGL 1711 Composition 1 – 4 cr	
ENGL 1712 Composition 2 – 2 cr	
COMM 17XX – 3cr	
<input type="checkbox"/> Goal 3: Natural Sciences	4
Goal 3 met with courses above.	
<input type="checkbox"/> Goal 4: Mathematical/Logical Reasoning.	3
MATH 1730 College Algebra (or higher) – 3 cr	
<input type="checkbox"/> Goal 5: History, Social Science and Behavioral Sciences	9
Minimum of three courses from two different disciplines	
<input type="checkbox"/> Goal 6: Humanities and Fine Arts.	9
Minimum of three courses from two different disciplines	
<input type="checkbox"/> Goals 1-10 of the Minnesota Transfer Curriculum	3-4
Select a minimum of 3 additional credits	
General Education Requirements	33-34

Total Program Credits 60

Minimum Program Entry Requirements

Students entering this program must meet the following minimum program entry requirements:

Reading: Score of 78+ or grade of "C" or better in READ 0722

Writing: Score of 78+ on Reading Comprehension or grade of "C" or better in ENGL 0922

College Level Mathematics: Score of 50+ or grade of "C" or better in MATH 0920

Assessment Results and Prerequisites: Students admitted into Saint Paul College programs may need to complete additional courses based on assessment results and course prerequisite requirements. Certain MATH, READ, and ENGL courses have additional prerequisites.

TPBI

*Information is subject to change.
This Program Requirements Guide is not a contract.*

Biology Transfer Pathway AS DEGREE *(continued)*

Course Sequence

This course sequence is recommended for a full-time student; however, this sequence is not required. Not all courses are offered each semester; a selection of courses is offered summer term. Students should consult with the Program Faculty each semester.

First Semester

Goal 1: ENGL 1711 Composition 1	4
Goal 1: COMM 17XX	3
Goal 3: BIOL 1740 General Biology 1	5
Goal 4: MATH 1730 College Algebra	3
Total Semester Credits	15

Second Semester

Goal 1: ENGL 1712 Composition 2	2
Goal 3: BIOL 1745 General Biology 2	5
Goal 3: CHEM 1711 Principles of Chemistry 1	4
Goal 5: History, Social Science and Behavioral Sciences	3
Total Semester Credits	14

Third Semester

Goal 3: CHEM 1712 Principles of Chemistry 2	4
Goal 3: BIOL 2755 Genetics	4
Goal 5: History, Social Science and Behavioral Sciences	3
Goal 6: Humanities and Fine Arts	3
Total Semester Credits	14

Fourth Semester

Goal 5: History, Social Science and Behavioral Sciences	3
Goal 6: Humanities and Fine Arts	6
Goals 1-10 MnTC Elective	3-4
Program Electives	4-5
Total Semester Credits	17

Total Program Credits60

Transfer Opportunities

Saint Paul College has a transfer articulation agreement between the following program and post-secondary institution for the baccalaureate degree program listed below.

For more information please go to saintpaul.edu/Transfer.

Biology Transfer Pathway AS

BS	Biology – General Biology
BS	Biology – Ecology, Biodiversity, and Evolutionary Biology
BS	Biology – Environmental Science Bemidji State University
BA	Biology Metropolitan State University
BA	Biology
BS	Biology Minnesota State University, Mankato
BA	Biology
BA	Ecology Minnesota State University, Moorhead
BA	Biology Concentration Southwest Minnesota State University
BA	Biology St. Cloud State University
BA	Biology Winona State University

Chemistry Transfer Pathway AS DEGREE

Program Overview

The Chemistry Transfer Pathway AS degree is awarded for successful completion of 60 credits in science and liberal arts. It is designed to constitute the first two years of a bachelor's degree in Chemistry.

Career Opportunities

Chemistry majors are curious, analytical and self-starting leaders. Upon completion of the Chemistry AS degree, students will have developed strong communication skills and grown in their scientific and mathematical reasoning skills as well as developed their ability to perform experiments in a hands-on environment. As graduates in Chemistry, students can choose a number of career options from technical scientific laboratory careers to education. Salaries will vary based on the chosen career path.

Program Outcomes

Students should be able to:

1. Demonstrate basic knowledge and understanding of the fundamentals of experimental and theoretical chemistry.
2. Explain and apply skills in analytical thinking and problem solving, and apply scientific methods to experimental data.
3. Demonstrate skills in laboratory operations including making accurate and precise measurements, preparing solutions, operating instrumentation, experimental design, and the interpretation and reporting of quantitative and qualitative data and results.
4. Communicate their own data and analysis in oral and written communications that uses tables and graphs, describes detailed experimental procedures, and clearly explains conclusions, in order to create clear and compelling papers, posters, or presentations.
5. Work both independently and collaboratively in the classroom and in the laboratory.
6. Apply learned concepts to everyday situations and experiences and critically evaluate contributions to science reported in the media; identify valid approaches to scientific problem solving and reporting.

Transfer Opportunities

Saint Paul College has a transfer articulation agreement between the following program and post-secondary institution for the baccalaureate degree program listed below.

For more information please go to saintpaul.edu/Transfer.

*Information is subject to change.
This Program Requirements Guide is not a contract.*

Chemistry Transfer Pathway AS

BS	Chemistry
BA	Individualized Studies
	Metropolitan State University
BS	Chemistry
	Minnesota State University, Mankato (ACS Approved)
BA	Chemistry
	Southwest Minnesota State University
BS	Chemistry
	St. Cloud State University (ACS Approved)

Program Faculty

Zubah Kpanaku	zubah.kpanaku@saintpaul.edu
Travis Mills	travis.mills@saintpaul.edu
Penny Starkey	penny.starkey@saintpaul.edu

Program Requirements

Check off when completed

Course	Cr
<input type="checkbox"/> CHEM 1711 Principles of Chemistry 1	4
<input type="checkbox"/> CHEM 1712 Principles of Chemistry 2	4
<input type="checkbox"/> CHEM 2720 Organic Chemistry 1	5
<input type="checkbox"/> CHEM 2721 Organic Chemistry 2	5
<input type="checkbox"/> PHYS 2700 General Physics 1 (w/Calc)	5
<input type="checkbox"/> PHYS 2710 General Physics 2 (w/Calc)	5
Subtotal	28

General Education/MnTC Requirements

Refer to the Minnesota Transfer Curriculum Course List for each Goal Area

<input type="checkbox"/> Goal 1: Communication	9
ENGL 1711 Composition 1 – 4 cr	
ENGL 1712 Composition 2 – 2 cr	
COMM 17XX – 3 cr	
<input type="checkbox"/> Goal 3: Natural Science	0
Met with courses from above.	
<input type="checkbox"/> Goal 4: Mathematical/Logical Reasoning	8
MATH 2749 Calculus 1 – 4 cr	
MATH 2750 Calculus 2 – 4 cr	
<input type="checkbox"/> Goal 5: History, Social Science, and Behavioral Sciences	3
<input type="checkbox"/> Goal 6: Humanities & Fine Arts	3
<input type="checkbox"/> Goals 1-10 of the MnTC	9

Students must select a minimum of 9 additional credits such that courses from at least six (6) goal areas of the Minnesota Transfer Curriculum are met.

General Education Requirements 32

Total Program Credits 60

Program Start Dates

Fall, Spring, Summer

Course Sequence

This course sequence is recommended for a full-time student; however, this sequence is not required. Not all courses are offered each semester; a selection of courses is offered summer term. Students should consult with the Program Faculty each semester.

First Semester

Goal 1: ENGL 1711 Composition	4
Goal 1: COMM 17XX	3
Goal 3: CHEM 1711 Principles of Chemistry 1	4
Goal 4: MATH 2749 Calculus 1	4
Total Semester Credits	15

Second Semester

Goal 3: CHEM 1712 Principles of Chemistry 2	4
Goal 3: PHYS 2700 General Physics 1 (w/Calc)	5
Goal 5: History, Social Science, and Behavioral Sciences	3
MnTC elective	3
Total Semester Credits	15

Third Semester

Goal 1: ENGL 1712 Composition 2	2
Goal 3: PHYS 2710 General Physics 2	5
Goal 3: CHEM 2720 Organic Chemistry 1	5
Goal 6: Humanities & Fine Arts	3
Total Semester Credits	15

Fourth Semester

Goal 3: BIOC 2700 Biochemistry	4
Goal 3: CHEM 2721 Organic Chemistry 2	5
MnTC elective	6
Total Semester Credits	15

Total Program Credits 60

Minimum Program Entry Requirements

Students entering this program must meet the following minimum program entry requirements:

Reading: Score of 78+ or grade of "C" or better in READ 0722

Writing: Score of 78+ on Reading Comprehension or grade of "C" or better in ENGL 0922

College Level Mathematics: Score of 50+ or grade of "C" or better in MATH 0920

Assessment Results and Prerequisites: Students admitted into Saint Paul College programs may need to complete additional courses based on assessment results and course prerequisite requirements. Certain MATH, READ, and ENGL courses have additional prerequisites.

TPCH

Science Technician AS DEGREE

Program Overview

The Science Technician degree is designed for students who are seeking employment in a science laboratory and/or who are seeking to transfer to a four-year program.

Career Opportunities

Science technicians can work in many aspects of the laboratory process industry from basic research to clean room facility skills. Technicians operate many kinds of equipment and instrumentation, prepare samples for processing, monitor commercial production, test for product quality and collect and analyze samples. Technicians will conduct a variety of laboratory procedures, from routine process of laboratory procedures to complex research projects. A solid background in science and math along with the skills in using advanced equipment is vital for success as a Science Technician.

Program Outcomes

1. Design and conduct experiments as well as analyze and interpret the results.
2. Identify, formulate, and solve science technology problems.
3. Understand professional and ethical responsibility.
4. Apply knowledge of mathematics, science, and technology in the solution of chemical technology problems.
5. Solve science technology problems within realistic constraints such as economic, environmental, social, political, ethical, and health and safety, manufacturability, and sustainability.

Transfer Opportunities

Saint Paul College has a transfer articulation agreement between the following program and post-secondary institution for the baccalaureate degree program listed below.

For more information please go to saintpaul.edu/Transfer.

Science Technician AS

BA	Individualized Studies Metropolitan State University
BS	Chemistry Metropolitan State University

Program Faculty

Travis Mills	travis.mills@saintpaul.edu
Penny Starkey	penny.starkey@saintpaul.edu

Program Requirements

- Check off when completed
 Science and Engineering Core: Required

Course	Cr
<input type="checkbox"/> BIOC 1730 Biochemical Laboratory Exploration . . .	4
<input type="checkbox"/> CHEM 1712 Principles of Chemistry 2	4
<input type="checkbox"/> CHEM 2730 Instrumental Analysis	4
<input type="checkbox"/> CHEM 2790 Science Technician Laboratory Research Project	3
<input type="checkbox"/> ENGR 1706 Principles of Engineering	2
Subtotal.	17

Science and Engineering Focus (Select one focus area)

Chemistry

- CHEM 2721 Organic Chemistry 2 5
 Science or Engineering Electives 8

Biochemistry

- BIOC 2700 Biochemistry 4
 Science or Engineering Electives 9

Physics

- PHYS 2710 General Physics 2. 5
 Science or Engineering Electives 8

Engineering

- ENGR 2700 Intro to Problem Solving and
 Engineering Design 2
 Science or Engineering Electives 11
Focus Subtotal. **13**

Note: Science/engineering electives must be taken from: BIOC, BIOL, CHEM, CSCI, ENGR, NSCI, PHYS. Consult with your advisor for information about 2, 3, and 4 credit course options.

General Education/MnTC Requirements

Refer to the Minnesota Transfer Curriculum Course List for each Goal Area

<input type="checkbox"/> Goal 1: Communication	7
ENGL 1711 Composition 1 – 4 cr COMM 17XX – 3 cr	
<input type="checkbox"/> Goal 3: Natural Science	4
CHEM 1711 Principles of Chemistry 1 – 4 cr	
<input type="checkbox"/> Goal 4: Mathematical/Logical Reasoning.	8
MATH 2749 Calculus 1 – 4 cr MATH 2750 Calculus 2 – 4 cr	
<input type="checkbox"/> Goal 5: History, Social Science and Behavioral Sciences	3
<input type="checkbox"/> Goal 6: Humanities and Fine Arts.	3
<input type="checkbox"/> Goals 1-10 of the Minnesota Transfer Curriculum	5
Students must select a minimum of 5 additional credits such that courses from at least six (6) goal areas of the Minnesota Transfer Curriculum are met.	
General Education Requirements	30
Total Program Credits	60

Program Start Dates

Fall, Spring, Summer

Course Sequence

This course sequence is recommended for a full-time student; however, this sequence is not required. Not all courses are offered each semester; a selection of courses is offered summer term. Students should consult with the Program Faculty each semester.

First Semester

ENGR 1706 Principles of Engineering	2
Goal 1: ENGL 1711 Composition 1.	4
Goal 3: CHEM 1711 Principles of Chemistry 1	4
Goal 5: History, Social Science and Behavioral Sciences	3
Goal 6: Humanities and Fine Arts	3
Total Semester Credits.	16

Second Semester

Goal 1: COMM 17XX	3
Goal 3: CHEM 1712 Principles of Chemistry 2	4
Goal 3: BIOC 1730 Biochemical Lab Exploration	4
Goal 4: MATH 2749 Calculus 1	4
Total Semester Credits.	15

Third Semester

Goal 3: CHEM 2730 Instrumental Analysis	4
Goal 4: MATH 2750 Calculus 2	4
MnTC Elective	3
Focus Area Course(s).	5
Total Semester Credits.	16

Fourth Semester

Goal 3: CHEM 2790 Science Tech Lab Research Project.	3
MnTC Elective: ENGL 1712 Composition 2 Recommended.	2
Focus Area Course(s).	8
Total Semester Credits.	13
Total Program Credits	60

Minimum Program Entry Requirements

Students entering this program must meet the following minimum program entry requirements:

Reading: Score of 78+ or grade of "C" or better in READ 0722

Writing: Score of 78+ on Reading Comprehension or grade of "C" or better in ENGL 0922

College Level Mathematics: Score of 50+ or grade of "C" or better in MATH 0920

Assessment Results and Prerequisites: Students admitted into Saint Paul College programs may need to complete additional courses based on assessment results and course prerequisite requirements. Certain MATH, READ, and ENGL courses have additional prerequisites. 377S (7210)

Information is subject to change.
 This Program Requirements Guide is not a contract.

Engineering Broad Field AS DEGREE

Program Overview

Engineering is a profession that uses basic knowledge from the mathematical and natural sciences and utilizes the materials and forces of nature to develop systems that will perform optimally and economically for the benefit of mankind. The Engineering Broad Field program is designed to provide for a student's first two years of a four-year Engineering degree. The curriculum is designed to meet the needs of those students who have not yet decided on a specific engineering field. The program focuses on developing a fundamental knowledge of physics, chemistry, and mathematics.

Career Opportunities

Engineering occupations are expected to grow by more than 10% through 2020 according to the Bureau of Labor Statistics. Engineering includes careers with branches in civil, agricultural, chemical, electrical, mechanical, and aerospace sciences to name a few. This degree is part of a state-wide articulation program and designed to transfer easily.

Program Outcomes

1. Apply knowledge of mathematics, science, and engineering in the solution of engineering problems.
2. Design and conduct experiments as well as analyze and interpret results.
3. Design and engineering system, component, or process to meet the desired needs within realistic constraints such as economic, environmental, social, political, ethical, health and safety, manufacturability, and sustainability.
4. Understand professional and ethical responsibility.
5. Recognize the need for and develop an ability to engage in life-long professional development and learning.
6. Utilize techniques, skills, and modern engineering tools necessary for engineering practice.

Program Faculty

Pam Schumacher pam.schumacher@saintpaul.edu

Part-Time/Full-Time Options

This program can be completed by using a combination of day, evening, Saturday, hybrid, and online courses. Part-time and full-time options are available.

Program Requirements

Check off when completed

Course	Cr
<input type="checkbox"/> ENGR 1707 Introduction to Engineering	3
Choose a focus:	
Electrical	
<input type="checkbox"/> CHEM 1712 Principles of Chemistry 2	4
<input type="checkbox"/> ENGR 1709 Digital Electronics	3
<input type="checkbox"/> ENGR 1717 Circuit Analysis 1	4
<input type="checkbox"/> ENGR 2705 Statics	3
<input type="checkbox"/> ENGR 2710 Dynamics	3
Mechanical or Manufacturing or Composite	
<input type="checkbox"/> CHEM 1712 Principles of Chemistry 2	4
<input type="checkbox"/> ENGR 1717 Circuit Analysis 1	4
<input type="checkbox"/> ENGR 2705 Statics	3
<input type="checkbox"/> ENGR 2710 Dynamics	3
<input type="checkbox"/> ENGR 2712 Deformable Body Mechanics	3
Civil	
<input type="checkbox"/> CHEM 1712 Principles of Chemistry 2	4
<input type="checkbox"/> ENGR 2705 Statics	3
<input type="checkbox"/> ENGR 2710 Dynamics	3
<input type="checkbox"/> ENGR 2712 Deformable Body Mechanics	3
<input type="checkbox"/> ENGR 2715 Thermodynamics	3
<input type="checkbox"/> ENGR Elective	1
Computer	
<input type="checkbox"/> CSCI 1410 Comp. Science & Info Systems	4
<input type="checkbox"/> CSCI Electives	6
<input type="checkbox"/> ENGR 1709 Digital Electronics	3
<input type="checkbox"/> ENGR 1717 Circuit Analysis 1	4
Integrated	
<input type="checkbox"/> CHEM 1712 Principles of Chemistry 2	4
<input type="checkbox"/> ENGR 1717 Circuit Analysis 1	4
<input type="checkbox"/> ENGR 2705 Statics	3
<input type="checkbox"/> ENGR 2710 Dynamics	3
<input type="checkbox"/> ENGR Elective	3
Subtotal	20

General Education/MnTC Requirements Cr

Refer to the Minnesota Transfer Curriculum Course List for each Goal Area

- Goal 1: Communication 4
ENGL 1711 Composition 1 – 4cr
- Goal 3: Natural Sciences 14
CHEM 1711 Principles of Chemistry 1 – 4 cr
PHYS 2700 General Physics 1 – 5 cr
PHYS 2710 General Physics 2 – 5 cr
- Goal 4: Mathematical/Logical Reasoning. 16
MATH 2749 Calculus 1 – 4 cr
MATH 2750 Calculus 2 – 4 cr
MATH 2753 Multivariable Calculus – 4 cr
MATH 2760 Differential Equations & Linear Algebra – 4 cr
- Goal 5: History, Social Science and Behavioral Sciences 3
- Goal 6: Humanities and Fine Arts. 3
*The course selected for goal area 5 or 6 must also satisfy goal 7, 8, 9, or 10.

General Education Requirements 40
Total Program Credits 60

Course Sequence

The course sequence listed on the back of this guide is recommended for a full-time student. Not all courses are offered every semester. Students should consult with the Program Faculty each semester.

See back of this guide for Course Sequence and Transfer Opportunities

Minimum Program Entry Requirements

Students entering this program must meet the following minimum program entry requirements:

Reading: Score of 78+ or grade of "C" or better in READ 0722

Writing: Score of 78+ or grade of "C" or better in ENGL 0922

College Level Mathematics: Score of 50+ or grade of "C" or better in MATH 0920

Assessment Results and Prerequisites:

Students admitted into Saint Paul College programs may need to complete additional courses based on assessment results and course prerequisite requirements. Certain courses in the program have additional prerequisites.

382S (7211)

*Information is subject to change.
This Program Requirements Guide is not a contract.*

Engineering Broad Field AS DEGREE *(continued)*

Program Start Dates

Fall, Spring, Summer

Course Sequence

This course sequence is recommended for a full-time student. Not all courses are offered every semester. Students should consult with the Program Faculty each semester.

First Semester

ENGR 1707 Introduction to Engineering	3
Goal 1: ENGL 1711 Composition 1	4
Goal 3: CHEM 1711 Principles of Chemistry 1	4
Goal 4: MATH 2749 Calculus 1	4
Total Semester Credits	15

Second Semester

Goal 3: CHEM 1712 Principles of Chemistry 2	4
Goal 3: PHYS 2700 General Physics 1	5
Goal 4: MATH 2750 Calculus 2	4
Goal 5: History, Social Science and Behavioral Sciences	3
Total Semester Credits	16

Third Semester

ENGR 2705 Statics	3
Goal 3: PHYS 2710 General Physics 2	5
Goal 4: MATH 2753 Multivariable Calculus	4
Goal 6: Humanities and Fine Arts	3
Total Semester Credits	15

Fourth Semester

ENGR 1717 Circuit Analysis	4
ENGR 2710 Dynamics	3
ENGR 2712 Deformable Body Mechanics	3
Goal 4: MATH 2760 Differential Equations & Linear Algebra	4
Total Semester Credits	14

Total Program Credits60

Transfer Opportunities

Saint Paul College has a transfer articulation agreement between the following program and post-secondary institution for the baccalaureate degree program listed below.

For more information please go to saintpaul.edu/Transfer.

Engineering Broad Field AS

BS	Composite Materials Engineering Winona State University
BS	Computer Engineering Saint Cloud State University
BS	Electrical Engineering Saint Cloud State University
BS	Manufacturing Engineering Saint Cloud State University
BS	Mechanical Engineering Saint Cloud State University
BSCS	Civil Engineering Minnesota State University, Mankato
BSE	General Engineering Minnesota State University, Mankato
BSE	Integrated Engineering Minnesota State University, Mankato *offered at Normandale location
BSEE	Electrical Engineering Minnesota State University, Mankato
BSEC	Computer Engineering Minnesota State University, Mankato
BSME	Mechanical Engineering Minnesota State University, Mankato

Computer Graphics and Visualization AS DEGREE

Program Overview

This program prepares students for jobs in the exciting computer graphics and animation field. Students will learn how to take an idea from concept through production including computer graphics, computer animation, sound and video.

Computer Graphics Specialists can work in a wide variety of creative jobs including web design, film and animation production, CD ROM production and any organization that can benefit from these special talents. With more and more animation moving to the desktop, the computer graphics specialist is becoming a high demand career.

The student should be creative and have excellent communication skills. Students should exhibit qualities of patience, and preciseness, and should enjoy working independently and on team projects.

Career Opportunities

The computer graphics field relates to many jobs in the multimedia area including but not limited to:

- Web Designer
- Computer Animator
- Computer Game Designer and Developer
- Multimedia Developer

Program Outcomes

1. Graduates will have knowledge and skills in web design.
2. Graduates will have knowledge and skills in computer animation.
3. Graduates will have knowledge and skills in digital sound and video production.
4. Graduates will have knowledge and skills in digital photography.
5. Graduates of this program may choose to continue their education at a four-year institution in computer graphics, technical communication or a related field.

Transfer Opportunities

Saint Paul College has a transfer articulation agreement between the following program and post-secondary institution for the baccalaureate degree program listed below.

For more information please go to saintpaul.edu/Transfer.

Computer Graphics and Visualization AS

BA	Individualized Studies Metropolitan State University
BA	Technical Communication and Professional Writing Metropolitan State University
BS	Information Technology Saint Mary's University, Twin Cities Campus

Program Faculty

Darren Pearson darren.pearson@saintpaul.edu

Recommended Equipment

Digital Camera, USB Drive, Adobe Software

Estimated Book Cost

\$50 - \$75 per class

Program Requirements

Check off when completed

Course	Cr
<input type="checkbox"/> CSCI 1450 Web Fundamentals/HTML	4
<input type="checkbox"/> DGIM 1400 Introduction to Computer Graphics	4
<input type="checkbox"/> DGIM 1443 Graphical Web Design 1	2
<input type="checkbox"/> DGIM 1448 Adobe Animate 1	2
<input type="checkbox"/> DGIM 1483 Photoshop 1	2
<input type="checkbox"/> DGIM 1484 Photoshop 2	2
<input type="checkbox"/> DGIM 1540 Blogging Applications	2
<input type="checkbox"/> DGIM 2586 Digital Sound	2
<input type="checkbox"/> DGIM 2587 Digital Video 1	2
<input type="checkbox"/> Technical Electives	8
Any 8 credits in DGIM or CSCI	
Subtotal	30

General Education/MnTC Requirements

Students must select courses from at least six (6) different Goal Areas of the MnTC.

Refer to the Minnesota Transfer Curriculum Course List for each Goal Area

<input type="checkbox"/> Goal 1: Communication	7
ENGL 1711 Composition 1 – 4 cr	
COMM 17XX – 3 cr	
<input type="checkbox"/> Goal 4: Mathematical/Logical Reasoning	3
<input type="checkbox"/> Goal 5: History, Social Science and Behavioral Sciences	4
<input type="checkbox"/> Goal 6: Humanities and Fine Arts	7
ARTS 1713 Photography 1 – 3 cr (recommended)	
<input type="checkbox"/> Goals 1-10 of the Minnesota Transfer Curriculum	9
Select a minimum of 9 additional credits	
General Education Requirements	30

Total Program Credits60

Program Start Dates

Fall, Spring, Summer

Course Sequence

The following sequence is recommended for a full-time student; however, this sequence is not required. Contact the Program Faculty with questions.

First Semester

CSCI 1450 Web Fundamentals/HTML	4
DGIM 1400 Introduction to Computer Graphics	4
DGIM 1443 Graphical Web Design 1	2
Goal 1: ENGL 1711 Composition I	4
Goal 1: COMM 17XX	3
Total Semester Credits	17

Second Semester

DGIM 1448 Adobe Animate 1	2
DGIM 1483 Photoshop 1	2
DGIM 1540 Blogging Applications (spring only)	2
Goal 5: History, Social Science and Behavioral Sciences	4
Goal 6: Humanities and Fine Arts	3
Total Semester Credits	13

Third Semester

DGIM 1484 Photoshop 2	2
DGIM 2586 Digital Sound	2
Goal 4: Mathematical/Logical Reasoning	3
Goal 6: Humanities and Fine Arts	4
Technical Electives	4
Total Semester Credits	15

Fourth Semester

DGIM 2587 Digital Video 1	2
MnTC Electives	9
Technical Electives	4
Total Semester Credits	15

Total Program Credits60

Minimum Program Entry Requirements

Students entering this program must meet the following minimum program entry requirements:

Reading: Score of 78+ or grade of "C" or better in READ 0722

Writing: Score of 78+ or grade of "C" or better in ENGL 0922

College Level Mathematics: Score of 50+ or grade of "C" or better in MATH 0920

Assessment Results and Prerequisites: Students admitted into Saint Paul College programs may need to complete additional courses based on assessment results and course prerequisite requirements. Certain MATH, READ, and ENGL courses have additional prerequisites.

255S (7116)

*Information is subject to change.
This Program Requirements Guide is not a contract.*

Visualization Technology AAS DEGREE

Program Overview

This program prepares students for jobs in the exciting computer graphics and animation field. Students will learn how to take an idea from concept through production, including computer graphics, computer animation, sound and video.

Computer Graphics Specialists can work in a wide variety of creative jobs including web design, film and animation production, CD ROM production and any organization that can benefit from these special talents. With more and more animation moving to the desktop, the computer graphics specialist is becoming a high demand career.

The student should be creative and have excellent communication skills. Students should exhibit qualities of patience and precision and enjoy working both independently and on team projects.

Career Opportunities

The computer graphics field relates to many jobs in the multimedia area including but not limited to:

- Web Designer
- Computer Animator
- Computer Game Designer and Developer
- Multimedia Developer

Program Outcomes

1. Graduates will have knowledge and skills in web design.
2. Graduates will have knowledge and skills in digital photography.
3. Graduates will have knowledge and skills in digital sound and video production.
4. Graduates will have developed an online portfolio of work
5. Graduates will have knowledge of freelancing and self-employment business practices

Transfer Opportunities

Saint Paul College has a transfer articulation agreement between the following program and post-secondary institution for the baccalaureate degree program listed below.

For more information please go to saintpaul.edu/Transfer.

Visualization Technology AAS

BA	Individualized Studies Metropolitan State University
BS	Information Technology Saint Mary's University, Twin Cities Campus
BS	Marketing Saint Mary's University, Twin Cities Campus
BS	Operations Management Minnesota State University, Moorhead

Program Faculty

Darren Pearson darren.pearson@saintpaul.edu

Recommended Equipment

USB Drive, Digital Camera, Adobe Software

Estimated Book Cost

\$50 - \$75 per class

Program Requirements

Check off when completed

Course	Cr
<input type="checkbox"/> CSCI 1450 Web Fundamentals/HTML	4
<input type="checkbox"/> DGIM 1400 Introduction to Computer Graphics	4
<input type="checkbox"/> DGIM 1448 Adobe Animate 1	2
<input type="checkbox"/> DGIM 1449 Adobe Animate 2	2
<input type="checkbox"/> DGIM 2560 Illustrator	4
<input type="checkbox"/> DGIM 2569 Digital Portfolio Development	2
<input type="checkbox"/> DGIM 2587 Digital Video 1	2
<input type="checkbox"/> DGIM 2588 Digital Video 2	2
<input type="checkbox"/> Technical Electives	6
Any 6 credits in DGIM or CSCI; ensure technical elective is not part of selected emphasis	
Subtotal	28

Select one of the emphases listed below

Web Emphasis

<input type="checkbox"/> CSCI 1470 Web Design	4
<input type="checkbox"/> DGIM 1443 Graphical Web Design 1	2
<input type="checkbox"/> DGIM 1444 Graphical Web Design 2	2
<input type="checkbox"/> DGIM 1483 Photoshop 1	2
<input type="checkbox"/> DGIM 1484 Photoshop 2	2
Total Emphasis Credits	12

Animation Emphasis

<input type="checkbox"/> DGIM 1490 3D Animation Fundamentals	4
<input type="checkbox"/> DGIM 2520 3D Character Animation	4
<input type="checkbox"/> DGIM 2704 3D Animation Capstone	4
Total Emphasis Credits	12

General Education/MnTC Requirements

Refer to the Minnesota Transfer Curriculum Course List for each Goal Area

<input type="checkbox"/> Goal 1: Communication	7
ENGL 1711 Composition 1 – 4 cr COMM 17XX – 3 cr	
<input type="checkbox"/> Goal 4: Mathematics/Logical Reasoning	3
MATH 1730 College Algebra – 3 cr OR PHIL 1710 Logic – 3 cr	
<input type="checkbox"/> Goal 5: History, Social Science and Behavioral Sciences	3
<input type="checkbox"/> Goal 6: Humanities and Fine Arts	3
<input type="checkbox"/> Goals 1-10 of the Minnesota Transfer Curriculum	4
Select a minimum of 4 additional credits	
General Education Requirements	20

Total Program Credits 60

Program Start Dates

Fall, Spring

Part-Time/Full-time Options

This program can be completed by using a combination of day, evening, and Saturday courses. Part-time and full-time options are available.

Course Sequence

The following course sequence is recommended; however, this sequence is not required. Contact the Program Faculty with questions.

See back of this guide for Course Sequence

Minimum Program Entry Requirements

Students entering this program must meet the following minimum program entry requirements:

Reading: Score of 78+ or grade of "C" or better in READ 0722

Writing: Score of 78+ or grade of "C" or better in ENGL 0922

College Level Mathematics: Score of 50+ or grade of "C" or better in MATH 0920

Assessment Results and Prerequisites:

Students admitted into Saint Paul College programs may need to complete additional courses based on assessment results and course prerequisite requirements. Certain MATH, READ, and ENGL courses have additional prerequisites.

215A (7093)

*Information is subject to change.
This Program Requirements Guide is not a contract.*

Visualization Technology AAS DEGREE *(continued)*

Course Sequence

The following course sequence is recommended; however, this sequence is not required. Contact the Program Faculty with questions.

First Semester

CSCI 1450 Web Fundamentals/HTML	4
DGIM 1400 Introduction to Computer Graphics	4
DGIM 1448 Adobe Animate 1	2
Goal 1: ENGL 1711 Composition I	4
Total Semester Credits	14

Second Semester

DGIM 1449 Adobe Animate 2	2
DGIM 2560 Illustrator	4
Goal 1: COMM 17XX	3
Goal 5: History, Social and Behavioral Sciences	3
Emphasis Course	4
Total Semester Credits	16

Third Semester

DGIM 2569 Digital Portfolio Development	2
DGIM 2587 Digital Video 1	2
Goal 4: MATH 1730 College Algebra	
OR PHIL 1710 Logic	3
Emphasis Course	4
Technical Elective(s)	4
Total Semester Credits	15

Fourth Semester

DGIM 2588 Digital Video 2	2
Goal 6: Humanities and Fine Arts	3
MnTC Electives	4
Technical Elective	2
Emphasis Course	4
Total Semester Credits	15

Total Program Credits	60
--	-----------

Visualization Technology CERTIFICATE

Program Overview

This certificate program is a series of entry level courses that are part of the Visualization Technology AAS degree at Saint Paul College.

This certificate option is available for students who may choose not to complete the entire AAS degree and gain some experience with courses used in computer graphics, particularly courses in the Adobe software suite.

Career Opportunities

The computer graphics field relates to many jobs in the multimedia area including but not limited to:

- Web Designer
- Computer Animator
- Computer Game Designer and Developer
- Multimedia Developer

Program Outcomes

1. Graduates will have basic skills to create documents with Adobe Illustrator.
2. Graduates will have basic skills to create websites using Adobe Dreamweaver.
3. Graduates will have basic skills for using Adobe Photoshop as a creative media.
4. Graduates will have the basic skills to create basic animations.
5. Graduates of this certificate may choose to continue with the AA or AAS degree in Visualization or a 4-year transfer opportunity is available.

Program Faculty

Darren Pearson darren.pearson@saintpaul.edu

Course Offering Options

This program can be completed by using a combination of day, evening, and Saturday courses. Part-time and full-time options are available.

Recommended Equipment

Digital Camera, USB Drive, Adobe Software

Estimated Book Cost

\$50 - \$75 per class

Program Requirements

Check off when completed

Course	Cr
<input type="checkbox"/> DGIM 1400 Introduction to Computer Graphics . . .	4
<input type="checkbox"/> DGIM 1443 Graphical Web Design 1	2
<input type="checkbox"/> DGIM 1448 Adobe Animate 1	2
<input type="checkbox"/> DGIM 1483 Photoshop 1	2
<input type="checkbox"/> DGIM 2560 Illustrator	4
Subtotal	14
<input type="checkbox"/> Technical Electives	4
Any DGIM or CSCI	
<input type="checkbox"/> General Education Requirements	3
General Education Requirements –3 cr	
Goal 6: Humanities and Fine Arts	
ARTS 17XX (recommended)	
Total Program Credits	21

Program Start Dates

Fall, Spring

Course Sequence

The following sequence is recommended; however, this sequence is not required. Contact the Program Faculty with questions.

First Semester

DGIM 1400 Introduction to Computer Graphics	4
DGIM 1443 Graphical Web Design 1	2
DGIM 1448 Adobe Animate 1	2
DGIM 1483 Photoshop 1	2
Total Semester Credits	10

Second Semester

DGIM 2560 Illustrator	4
Technical Electives	4
Goal 6: ARTS 17XX recommended	3
Total Semester Credits	11

Total Program Credits 21

Minimum Program Entry Requirements

Students entering this program must meet the following minimum program entry requirements:

Reading: Score of 38+

Arithmetic: Score of 20+

Assessment Results and Prerequisites:

Students admitted into Saint Paul College programs may need to complete additional courses based on assessment results and course prerequisite requirements. Certain MATH, READ, and ENGL courses have additional prerequisites.

289C (7153)

*Information is subject to change.
This Program Requirements Guide is not a contract.*

Computer Animation CERTIFICATE

Program Overview

The Computer Animation Certificate is intended to give students the skills needed to work as a digital animator. The classes required for this certificate will have students learning the

most up-to-date animation and video software packages including Blender, Flash, Premiere Pro, After Effects and other applications. Intensive hands-on participation will be stressed in creating 3D models, animations, and scenes. Emphasis is placed on practical, real-world application of their skills. Upon certificate completion, students will have multiple short animation projects suitable for a portfolio or demo reel.

Career Opportunities

Many career opportunities exist in the computer animation field, particularly for individuals with extensive portfolios. Jobs exist in the video game industry, web design and advertising focused on emerging technologies. Many computer animators begin their career as self-employed, freelancers, in order to expand their personal portfolio.

Program Outcomes

1. Graduates will have extensive knowledge and skills in computer animation using Blender.
2. Graduates will have knowledge and skills in computer animation using other various 3D animation tools.
3. Graduates will have knowledge and skills in basic video production.

Program Faculty

Darren Pearson darren.pearson@saintpaul.edu

Course Offering Options

This program can be completed by using a combination of day, evening, and Saturday courses. Part-time and full-time options are available.

Recommended Equipment

Digital Camera, USB Drive, Adobe Software

Program Requirements

Check off when completed

Course	Cr
<input type="checkbox"/> DGIM 1490 3D Animation Fundamentals	4
<input type="checkbox"/> DGIM 2520 3D Character Animation	4
<input type="checkbox"/> DGIM 2587 Digital Video 1	2
<input type="checkbox"/> DGIM 2588 Digital Video 2	2
<input type="checkbox"/> DGIM 2704 3D Animation Capstone	4
<input type="checkbox"/> DGIM XXXX	2
(Select any 2 credits in DGIM not already required for this program)	
Total Program Credits	18

Program Start Dates

Fall

Course Sequence

The following course sequence is recommended; however, this sequence is not required. Contact the Program Faculty with questions.

First Semester

DGIM 1490 3D Animation Fundamentals (fall only)	4
DGIM XXXX (Select any 2 credits in DGIM not already required for this program)	2
Total Semester Credits	6

Second Semester

DGIM 2520 3D Character Animation	4
DGIM 2587 Digital Video 1	2
DGIM 2588 Digital Video 2	2
Total Semester Credits	8

Third Semester

DGIM 2704 3D Animation Capstone	4
Total Semester Credits	4
Total Program Credits	18

Minimum Program Entry Requirements

Students entering this program must meet the following minimum program entry requirements:

Reading: Score of 38+

Arithmetic: Score of 20+

Assessment Results and Prerequisites:

Students admitted into Saint Paul College programs may need to complete additional courses based on assessment results and course prerequisite requirements. Certain MATH, READ, and ENGL courses have additional prerequisites.

336C (7191)

*Information is subject to change.
This Program Requirements Guide is not a contract.*

Web Design CERTIFICATE

Program Overview

This program prepares students for jobs in the exciting computer graphics field. Students will learn how to take an idea from concept through production including computer graphics and computer animation.

The student should be creative and have excellent communications skills. Students should exhibit qualities of patience and precision and should enjoy working both independently and on team projects.

Career Opportunities

The computer graphics field relates to many jobs in the multimedia area including but not limited to:

- Web Designer
- Web Developer

Program Outcomes

1. Graduates will have knowledge of front-end, web design software packages.
2. Graduates will have knowledge of back-end, web development software languages.
3. Graduates will have knowledge of usability, accessibility and search engine optimization practices.

Program Faculty

Darren Pearson darren.pearson@saintpaul.edu

Recommended Equipment

USB Drive, Digital Camera, Adobe Software

Program Requirements

Check off when completed

Course	Cr
<input type="checkbox"/> CSCI 1450 Web Fundamentals/HTML	4
<input type="checkbox"/> CSCI 1470 Web Design	4
<input type="checkbox"/> CSCI 2440 Client Side Programming 1	4
<input type="checkbox"/> DGIM 1443 Graphical Web Design 1	2
<input type="checkbox"/> DGIM 1448 Adobe Animate 1	2
<input type="checkbox"/> DGIM 2521 2D Web Animation	2

Total Program Credits 18

Program Start Dates

Fall, Spring

Course Sequence

The following course sequence is recommended; however, this sequence is not required. Contact the Program Faculty with questions.

First Semester

CSCI 1450 Web Fundamentals/HTML	4
DGIM 2521 2D Web Animation	2
Total Semester Credits	.6

Second Semester

CSCI 1470 Web Design	4
DGIM 1443 Graphical Web Design 1	2
DGIM 1448 Adobe Animate 1	2
Total Semester Credits	.8

Third Semester

CSCI 2440 Client Side Programming 1	4
Total Semester Credits	.4

Total Program Credits 18

Minimum Program Entry Requirements

Students entering this program must meet the following minimum program entry requirements:

Reading: Score of 78+ or grade of "C" or better in READ 0722

Writing: Score of 78+ or grade of "C" or better in ENGL 0922

Elementary Algebra: Score of 76+ or grade of "C" or better in MATH 0910

Assessment Results and Prerequisites: Students admitted into Saint Paul College programs may need to complete additional courses based on assessment results and course prerequisite requirements. Certain MATH, READ, and ENGL courses have additional prerequisites.

Degree option may have a greater requirement than this certificate.

178C (7113)

*Information is subject to change.
This Program Requirements Guide is not a contract.*

CyberSecurity AAS DEGREE

Program Overview

CyberSecurity professionals work in a wide variety of information technology positions, but have a focus on information assurance, cyber ethics, and incident detection, investigation and response. Students completing this degree will be able to investigate and defend computer systems against cyber-attacks, unauthorized use or modification, and exploitation.

Students entering into this program of study should have excellent communication, reading and math skills. Throughout the program students will experience coursework that will help them develop skills such as critical thinking, performance monitoring, decision making and evaluating systems and organizations.

The CyberSecurity program at Saint Paul College is 60 credits in length. The program provides 16 credits specifically related to CyberSecurity which will aid students in the field and in potential certifications.

Career Opportunities

CyberSecurity professionals will find a growing need in both public and private employment sectors. Graduates will find excellent opportunities as systems administrators, network engineers, system programmers, and systems specialists.

Program Outcomes

1. Graduates will have knowledge and skills in system design, analysis and maintenance.
2. Graduates will have the skills to gather, monitor, and analyze multiple sources of data to identify changes in circumstances or events.
3. Graduates will have the skills to evaluate information to determine compliance with security standards.
4. Graduates of the CyberSecurity program will be prepared for employment as information Security Analysts or Computer Systems Analysts.

Transfer Opportunities

Saint Paul College has a transfer articulation agreement between the following program and post-secondary institution for the baccalaureate degree program listed below.

For more information please go to saintpaul.edu/Transfer.

CyberSecurity AAS

- BA Individualized Studies
Metropolitan State University
- BS Information Technology
Saint Mary's University,
Twin Cities Campus
- BS Operations Management
Minnesota State University, Moorhead

Program Faculty

Mark Rawlings mark.rawlings@saintpaul.edu
James Woodcock
james.woodcock@saintpaul.edu

Program Requirements

Check off when completed

Course	Cr
<input type="checkbox"/> CSCI 1410 Computer Science & Information Systems	4
<input type="checkbox"/> CSCI 1423 Computer Networking 1 – Client	4
<input type="checkbox"/> CSCI 1440 Networking Fundamentals	4
<input type="checkbox"/> CSCI 1523 Intro to Computing and Programming Concepts	4
<input type="checkbox"/> CSCI 2420 Computer Security	4
<input type="checkbox"/> CSCI 2461 Computer Networking 3 – Linux	4
<input type="checkbox"/> CSCI 2465 Computer Networking 4 – Infrastructure	4
<input type="checkbox"/> CSCI 2480 Network Security and Penetration Prevention	4
<input type="checkbox"/> CSCI 2482 Security Incident Handling, Response and Disaster Recovery	4
<input type="checkbox"/> CSCI 2484 Ethical Hacking & Countermeasures	4
<input type="checkbox"/> CSCI 2570 Machine Architecture and Organization	4
Subtotal	44

General Education/MnTC Requirements

General Education/MnTC Requirements	Cr
Refer to the Minnesota Transfer Curriculum Course List for each Goal Area	
<input type="checkbox"/> Goal 1: Communication	7
ENGL 1711 Composition 1 – 4 cr COMM 17XX – 3 cr	
<input type="checkbox"/> Goal 3 or Goal 4	3
Goal 3: Natural Sciences OR Goal 4: Mathematical /Logical Reasoning	
<input type="checkbox"/> Goal 5: History, Social Science and Behavioral Sciences	3
<input type="checkbox"/> Goal 6: Humanities and Fine Arts	3
(PHIL 1720 Ethics is recommended)	
General Education Requirements	16

Total Program Credits 60

Program Start Dates

Fall, Spring, Summer

Course Sequence

This course sequence is recommended for a full-time student; however, this sequence is not required. Not all courses are offered each semester; a selection of courses is offered summer term. Students should consult with the Program Faculty each semester.

First Semester

CSCI 1410 Computer Science & Information Systems	4
CSCI 1423 Computer Networking 1 – Client	4
CSCI 1440 Networking Fundamentals	4
Goal 1: ENGL 1711 Composition 1	4
Total Semester Credits	16

Second Semester

CSCI 1523 Intro to Computing and Programming Concepts	4
CSCI 2461 Computer Networking 3 – Linux	4
CSCI 2570 Machine Architecture and Organization	4
Goal 6: Humanities and Fine Arts	3
(PHIL 1720 Ethics is recommended)	
Total Semester Credits	15

Third Semester

CSCI 2420 Computer Security	4
CSCI 2465 Computer Networking 4 – Infrastructure	4
Goal 1: COMM 17XX	3
Goal 3: Natural Sciences OR Goal 4: Mathematical /Logical Reasoning	3
(MATH 1730 or proficiency required)	
Total Semester Credits	14

Fourth Semester

CSCI 2480 Network Security and Penetration Prevention	4
CSCI 2482 Security and Incident Handling Response and Disaster Recovery	4
CSCI 2484 Ethical Hacking & Countermeasures	4
Goal 5: History, Social Science and Behavioral Sciences	3
Total Semester Credits	15

Total Program Credits 60

See back of this guide for Course Chart

*Information is subject to change.
This Program Requirements Guide is not a contract.*

CyberSecurity AAS DEGREE *(continued)*
 (44 credits + 16 GenEd credits)

The below chart illustrates the courses required for completion of this degree.

Introductory



Intermediate

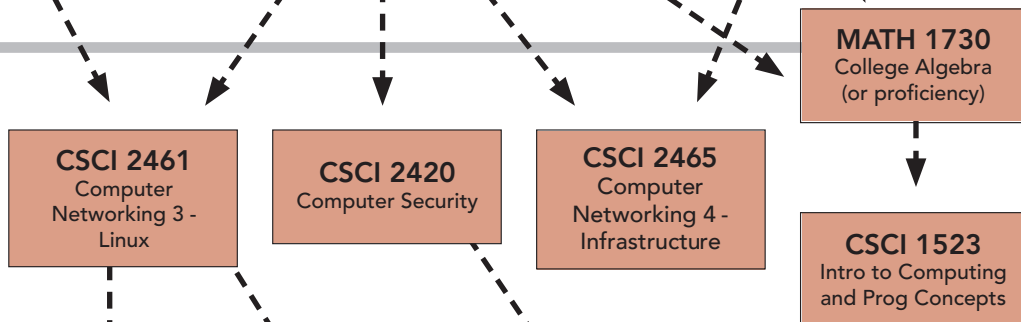

Advanced

(offered once per year)

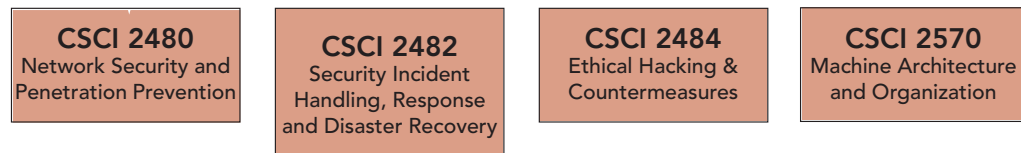

Minimum Program Entry Requirements
 Students entering this program must meet the following minimum program entry requirements:

Reading: Score of 78+ or grade of "C" or better in READ 0722

Writing: Score of 78+ on Reading Comprehension or grade of "C" or better in ENGL 0922

College Level Mathematics: Score of 50+ or grade of "C" or better in MATH 0920

Assessment Results and Prerequisites:
 Students admitted into Saint Paul College programs may need to complete additional courses based on assessment results and course prerequisite requirements. Certain MATH, READ, and ENGL courses have additional prerequisites.

352A (7203)

CyberSecurity CERTIFICATE

Program Overview

Note: Students must have completed the Computer Network Engineering AAS degree or have instructor approval.

CyberSecurity professionals work in a wide variety of information technology positions, but have a focus on information assurance, cyber ethics, and incident detection, investigation and response. Students completing this degree will be able to investigate and defend computer systems against cyber-attacks, unauthorized use or modification, and exploitation.

Students entering into this program of study should have excellent communication, reading and math skills. Throughout the program students will experience coursework that will help them develop critical skills such as critical thinking, performance monitoring, decision making and evaluating systems and organizations

The CyberSecurity certificate program at Saint Paul College is 24 credits in length. The program provides 16 credits specifically related to CyberSecurity which will aid students in the field and in potential certifications.

Career Opportunities

CyberSecurity professionals will find a growing need in both the public and private employment sectors. Graduates will find excellent opportunities as systems administrators, network engineers, system programmers, and systems specialists.

Program Outcomes

1. Graduates will have knowledge and skills in system design, analysis and maintenance.
2. Graduates will have the skills to gather, monitor, and analyze multiple sources of data to identify changes in circumstances or events.
3. Graduates will have the skills to evaluate information to determine compliance with security standards.
4. Graduates of the CyberSecurity program will be prepared for employment as Information Security Analyst or Computer Systems Analysts.

Program Faculty

Mark Rawlings mark.rawlings@saintpaul.edu
James Woodcock james.woodcock@saintpaul.edu

Program Requirements

Check off when completed

Course	Cr
<input type="checkbox"/> CSCI 1440 Networking Fundamentals	4
<input type="checkbox"/> CSCI 2420 Computer Security	4
<input type="checkbox"/> CSCI 2451 Computer Networking 2 - Server	4
<input type="checkbox"/> CSCI 2480 Network Security and Penetration Prevention	4
<input type="checkbox"/> CSCI 2482 Security Incident Handling, Response and Disaster Recovery	4
<input type="checkbox"/> CSCI 2484 Ethical Hacking & Countermeasures	4
Subtotal	24

Total Program Credits 24

Program Start Dates

Fall, Spring

Course Sequence

This course sequence is recommended for a full-time student; however, this sequence is not required. Not all courses are offered each semester; a selection of courses is offered summer term. Students should consult with the Program Faculty each semester.

First Semester

CSCI 1440 Networking Fundamentals	4
CSCI 2420 Computer Security	4
CSCI 2451 Computer Networking 2 - Server	4
Total Semester Credits	12

Second Semester

CSCI 2480 Network Security and Penetration Prevention	4
CSCI 2482 Security and Incident Handling Response and Disaster Recovery	4
CSCI 2484 Ethical Hacking & Countermeasures	4
Total Semester Credits	12

Total Program Credits 24

Minimum Program Entry Requirements

Students entering this program must meet the following minimum program entry requirements:

Reading: Score of 78+ or grade of "C" or better in READ 0722

Writing: Score of 78+ on Reading Comprehension or grade of "C" or better in ENGL 0922

Elementary Algebra: Score of 76+ or grade of "C" or better in MATH 0910

Students enrolling in the Certificate should have previous networking experience or consider taking additional networking courses as identified by the instructor/advisors.

Assessment Results and Prerequisites: Students admitted into Saint Paul College programs may need to complete additional courses based on assessment results and course prerequisite requirements. Certain MATH, READ, and ENGL courses have additional prerequisites.

352C

*Information is subject to change.
This Program Requirements Guide is not a contract.*

Computer Science Transfer Pathway AS DEGREE

Program Overview

The Computer Science Transfer Pathway AS Degree is designed to provide students with opportunities for immediate employment or for transfer to four-year institutions. The College has developed articulation agreements with four-year institutions to assist students with their transfer goals. See a Pathway Advisor for further information. Students planning a career in this area should have above average mathematic reasoning and communication skills. Students should exhibit qualities of patience, and preciseness and enjoy working in a team environment.

Career Opportunities

Graduates of this program may choose to continue their education at a four-year institution in a Computer Science or related field. Others may elect to enter the workforce following graduation. Graduates will find opportunities in the computer science field in the areas of programming or database management in business, manufacturing, government and education. With additional education and experience, students may advance to positions such as Database Analyst, Systems Analyst, Software Developer or Programmer-Analyst.

Program Outcomes

1. Graduates will be able to develop complex algorithms which underlie common programming tasks.
2. Graduates will be able to construct and analyze the performance of complex data structures and use them to develop efficient computer programs.
3. Graduates will have a sound understanding of the mathematics that underlies Computer Science and be able to develop and deploy computer programs which utilize it.
4. Graduates of the program will have mastered the general education requirements for work and life roles.

Minimum Program Entry Requirements

Students entering this program must meet the following minimum program entry requirements:

Reading: Score of 78+ or grade of "C" or better in READ 0722

Writing: Score of 78+ or grade of "C" or better in ENGL 0922

College Level Mathematics: Score of 50+ or grade of "C" or better in MATH 0920

Assessment Results and Prerequisites:

Students admitted into Saint Paul College programs may need to complete additional courses based on assessment results and course prerequisite requirements. Certain MATH, READ, and ENGL courses have additional prerequisites.

TPCS

Program Faculty

Warren Sheaffer warren.sheaffer@saintpaul.edu

Part-time/Full-time Options

Some day and evening class availability. Students may attend full-time or part-time.

Program Requirements

Check off when completed

Course	Cr
<input type="checkbox"/> CSCI 1410 Computer Science & Info Systems	4
<input type="checkbox"/> CSCI 1523 Intro to Computing and Programming Concepts	4
<input type="checkbox"/> CSCI 1524 Intro to Algorithms & Data Structures	4
<input type="checkbox"/> CSCI 1533 ANSI C Language Programming	2
<input type="checkbox"/> CSCI 1541 Java Programming 1	4
<input type="checkbox"/> CSCI 2460 Discrete Structures of Computer Science	4
<input type="checkbox"/> CSCI 2469 Advanced Programming Principles	4
<input type="checkbox"/> CSCI 2570 Machine Architecture & Organization	4
Subtotal	30

General Education/MnTC Requirements

Refer to the Minnesota Transfer Curriculum Course List for each Goal Area

<input type="checkbox"/> Goal 1: Communication	9
ENGL 1711 Composition 1 – 4 cr	
ENGL 1712 Composition 2 -- 2 cr	
COMM 17XX – 3 cr	
<input type="checkbox"/> Goal 3: Natural Sciences	5
PHYS 2700 General Physics 1 – 5 cr	
<input type="checkbox"/> Goal 4: Mathematical/Logical Reasoning	8
MATH 2749 Calculus 1 - 4 cr	
MATH 2750 Calculus 2 OR	
MATH 1740 Introduction to Statistics - 4 cr	
<input type="checkbox"/> Goal 5: History, Social Science and Behavioral Sciences	3
<input type="checkbox"/> Goal 6: Humanities and Fine Arts	3
<input type="checkbox"/> Goals 1-10 of the Minnesota Transfer Curriculum	2
Select a minimum of 2 additional credits.	
Students must select courses from at least six (6) Goal Areas of the Minnesota Transfer Curriculum.	
General Education Requirements	30

Total Program Credits60

* Please refer to specific articulation agreements to determine the best mathematics option.

*Information is subject to change.
This Program Requirements Guide is not a contract.*

Program Start Dates

Fall, Spring, Summer

Course Sequence

The following sequence is recommended for a full-time student. Not all courses are offered each semester.

First Semester

CSCI 1410 Computer Science & Info Systems	4
Goal 1: ENGL 1711 Composition 1	4
Goal 4: MATH 2749 Calculus 1	4
Goals 1-10 of the Minnesota Transfer Curriculum	2
Total Semester Credits	14

Second Semester

CSCI 1523 Intro to Computing and Programming Concepts	4
Goal 3: PHYS 2700 General Physics 1	5
Goal 4: MATH 2750 Calculus 2	
OR MATH 1740 Intro to Statistics	4
Goal 5: History, Social Sciences, Behavioral	3
Total Semester Credits	16

Third Semester

CSCI 1533 ANSI C Language Programming	2
CSCI 1541 Java Programming 1	4
CSCI 2570 Machine Architecture & Organization	4
Goal 1: ENGL 1712 Composition 2	2
Goal 1: COMM 17XX	3
Total Semester Credits	15

Fourth Semester

CSCI 1524 Intro to Algorithms and Data Structures	4
CSCI 2460 Discrete Structures of Comp Science	4
CSCI 2469 Advanced Programming Principles	4
Goal 6: Humanities and Fine Arts	3
Total Semester Credits	15

Total Program Credits60

See back of this guide for Transfer Opportunities

Computer Science Transfer Pathway AS DEGREE *(continued)* (30 credits + 30 GenEd credits)

Transfer Opportunities

Saint Paul College has a transfer articulation agreement between the following program and post-secondary institution for the baccalaureate degree program listed below. For more information please go to saintpaul.edu/Transfer.

Computer Science Transfer Pathway AS

BS	Computer Science	BS	Computer Science
	Bemidji State University	BA	Individualized Studies
BS	Computer Information Systems		Metropolitan State University
	College of St. Scholastica	BS	Information Technology
			Saint Mary's University, Twin Cities Campus
		BS	Computer Science
			Southwest Minnesota State University
		BS	Computer Science
			St. Cloud State University

The below chart illustrates the courses required for completion of this degree.

Introductory

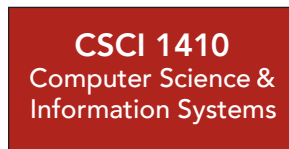

Intermediate

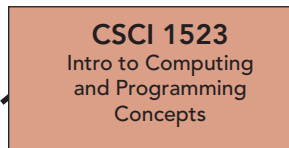

Advanced

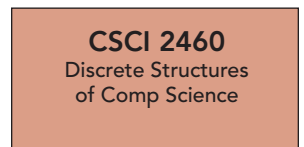
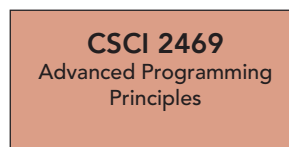
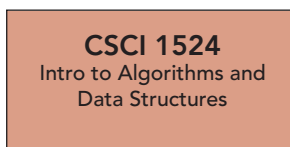
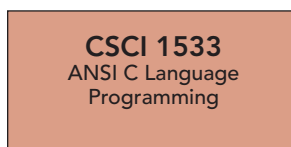

Management Information Systems AS DEGREE

Program Overview

The Associate of Science Degree in Management Information Systems is designed to provide students with opportunities for immediate employment or for transfer to four-year institutions. The College has developed articulation agreements with four-year institutions to assist students with their transfer goals. See a Transfer Specialist for further information.

Students planning a career in this area should have above average mathematic reasoning and communication skills. Students should exhibit qualities of patience, perseverance, and preciseness, and should enjoy working in a team environment.

Career Opportunities

A management information system degree prepares the student for a career that combines business techniques and computer systems capability. Students study how to provide reporting and analysis using best practices in information technology.

Graduates will find opportunities in the information systems field in business, manufacturing, government and education.

With additional education and experience, students may advance to positions such as Systems Analyst, Software Architect and Business Analyst. Graduates of this program may choose to continue their education at a four-year institution in Management Information Systems or a related field. Others may elect to enter the workforce following graduation.

Program Outcomes

1. Graduates will be able to analyze complex business processes and develop process improvements and comprehensive information system requirements specifications to support them.
2. Graduates will be able to help build and test information systems in an organization.
3. Graduates will be able to utilize accounting and business systems information to develop recommendations for operating cost reduction and improved use of capital investment.
4. Graduates will have a sound understanding of business systems, current technologies, organizational structures, communication tools and critical thinking skills to help guide Management Information Systems success.

Program Faculty

Warren Sheaffer warren.sheaffer@saintpaul.edu

Part-time and Full-time Options

This program can be completed by using a combination of day, evening, and Saturday courses. Part-time and full-time options are available.

Program Requirements

Check off when completed

Course	Cr
<input type="checkbox"/> ACCT 2410 Financial Accounting	4
<input type="checkbox"/> BUSN 2110 Principles of Marketing	3
<input type="checkbox"/> BUSN 2450 Management Fundamentals	3
<input type="checkbox"/> CSCI 1410 Computer Science & Information Systems	4
<input type="checkbox"/> CSCI 1450 Web Fundamentals/HTML	4
<input type="checkbox"/> CSCI 1523 Intro to Computing and Programming Concepts	4
<input type="checkbox"/> CSCI 1550 Database Management Fundamentals	4
<input type="checkbox"/> CSCI 2410 Management Information Systems	3
Subtotal	29

General Education/MnTC Requirements Cr

Refer to the Minnesota Transfer Curriculum Course List for each Goal Area

<input type="checkbox"/> Goal 1: Communication	7
ENGL 1711 Composition 1 – 4 cr	
COMM 17XX – 3 cr	
<input type="checkbox"/> Goal 4: Mathematical/Logical Reasoning	7-8
MATH 1740 Introduction to Statistics – 4 cr	
MATH 1730 College Algebra – 3 cr OR	
MATH 2749 Calculus 1 – 4 cr	
<input type="checkbox"/> Goal 5: History, Social Science and Behavioral Sciences	6
ECON 1720 Macroeconomics – 3 cr	
ECON 1730 Microeconomics – 3 cr	
<input type="checkbox"/> Goals 1-10 of the Minnesota Transfer Curriculum	10-11
Select a minimum of 10-11 additional credits	
Students must select courses from at least six (6) Goal Areas of the Minnesota Transfer Curriculum.	
General Education Requirements	31

Total Program Credits60

Program Start Dates

Fall, Spring, Summer

Course Sequence

The following sequence is recommended for a full-time student. Not all courses are offered each semester.

First Semester

BUSN 2450 Management Fundamentals	3
CSCI 1410 Computer Science & Info Systems	4
Goal 1: ENGL 1711 Composition 1	4
Goal 4: MATH 1730 College Algebra	
OR MATH 2749 Calculus 1	3-4
Total Semester Credits	14-15

Second Semester

ACCT 2410 Financial Accounting	4
BUSN 2110 Principles of Marketing	3
CSCI 1523 Introduction to Computing and Programming Concepts	4
Goal 4: MATH 1740 Introduction to Statistics	4
Total Semester Credits	15

Third Semester

CSCI 1450 Web Fundamentals/HTML	4
CSCI 1550 Database Management Fundamentals	4
Goal 1: COMM 17XX	3
Goal 5: ECON 1720 Macroeconomics	3
MnTC Electives	3
Total Semester Credits	17

Fourth Semester

CSCI 2410 Management Information Systems	3
Goal 5: ECON 1730 Microeconomics	3
MnTC Electives	7-8
Total Semester Credits	13-14

Total Program Credits60

See back of this guide for Transfer Opportunities

*Information is subject to change.
This Program Requirements Guide is not a contract.*

Management Information Systems AS DEGREE *(continued)*

(29 credits + 31 GenEd credits)

Transfer Opportunities

Saint Paul College has a transfer articulation agreement between the following program and post-secondary institution for the baccalaureate degree program listed below.

For more information please go to saintpaul.edu/Transfer.

Management Information Systems AS

BA Individualized Studies
Metropolitan State University

- BS Computer Information Systems
College of St. Scholastica
- BS Information Technology
Saint Mary's University,
Twin Cities Campus
- BS Management Information Systems
Metropolitan State University

Minimum Program Entry Requirements

Students entering this program must meet the following minimum program entry requirements:

Reading: Score of 78+ or grade of "C" or better in READ 0722

Writing: Score of 78+ or grade of "C" or better in ENGL 0922

College Level Mathematics: Score of 50+ or grade of "C" or better in MATH 0920

Assessment Results and Prerequisites: Students admitted into Saint Paul College programs may need to complete additional courses based on assessment results and course prerequisite requirements. Certain MATH, READ, and ENGL courses have additional prerequisites.

232S (7102)

The below chart illustrates the courses required for completion of this degree.

Introductory

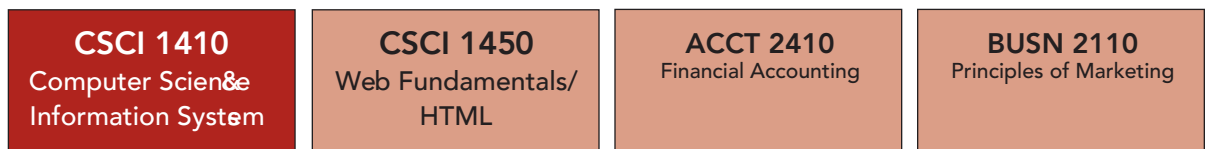

Intermediate

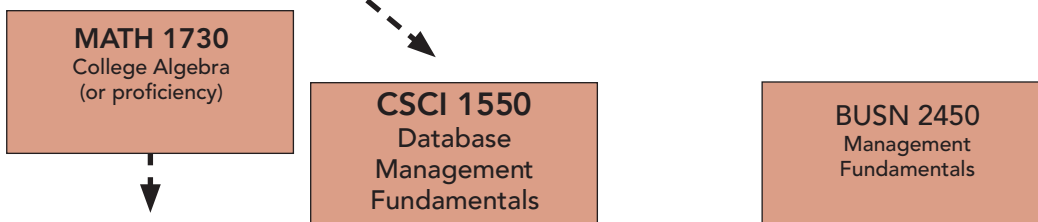

Advanced

(offered once per year)

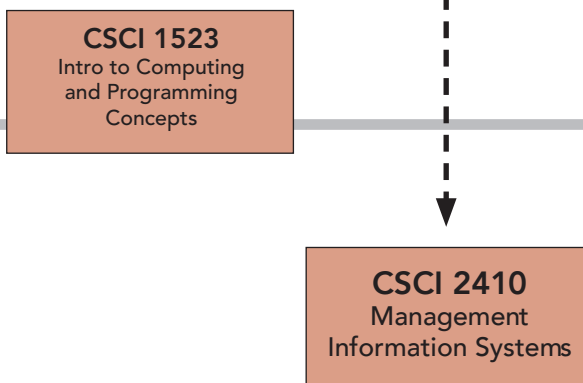

Computer Network Engineering AAS DEGREE

Program Overview

Networking Specialists can work in a wide variety of jobs. The work could include purchasing, installing, configuring, administrating and/or supporting. Some jobs in networking could include computer network support, user training, installing and maintaining local and/or wide area networks.

The student should have excellent communication and math skills. For the certificate programs, the student is expected to have prior microcomputer and/or networking experience. He/she should exhibit qualities of patience, perseverance and preciseness and be a logical thinker. The student should enjoy working in a team environment and be able to work independently.

Career Opportunities

With almost every size company connected to some type of network, the jobs in networking have become the fastest growing jobs in the computer field. With companies networking to share resources and reduce expenses the networking specialist is an invaluable part of the new company structure. There is a wide variety of jobs in networking including installation, maintenance, training, managing and user support.

Graduates find excellent opportunities as Network Administrators, Network Support, and Certified Network Engineers in business, manufacturing, government and education. Jobs for Networking Specialists for all types of installations are found throughout the country with opportunities for excellent earnings and rapid advancement. Jobs include the following:

- Networking Engineer
- Network Help Desk Support
- Data Communications Specialist
- PC Network Administrator
- Information Specialist
- WAN Manager Network Administrator
- LAN Specialist
- Telecommunications Specialist
- Certified Network Engineer
- LAN Manager

Program Outcomes

1. Graduates will have knowledge and skills in computer network engineering.
2. Graduates will have knowledge and experience in system design, analysis and maintenance.
3. Graduates of the Computer Network programs will be prepared for employment as computer network engineers.
4. Graduates will be prepared to take industry certification exams.

Program Faculty

Warren Sheaffer
warren.sheaffer@saintpaul.edu

Part-Time/Full-Time Options

Some day and evening class availability. Students may attend full time or part time.

Program Requirements

Check off when completed

Course	Cr
<input type="checkbox"/> CSCI 1410 Computer Science & Information Systems	4
<input type="checkbox"/> CSCI 1423 Computer Networking 1 – Client	4
<input type="checkbox"/> CSCI 1440 Networking Fundamentals	4
<input type="checkbox"/> CSCI 1523 Intro to Computing and Programming Concepts	4
<input type="checkbox"/> CSCI 2420 Computer Security	4
<input type="checkbox"/> CSCI 2451 Computer Networking 2 – Server	4
<input type="checkbox"/> CSCI 2453 Computer Virtualization	4
<input type="checkbox"/> CSCI 2461 Computer Networking 3 – Linux	4
<input type="checkbox"/> CSCI 2465 Computer Networking 4 – Infrastructure	4
<input type="checkbox"/> CSCI 2475 A+ Hardware/Operating System Prep	4
<input type="checkbox"/> CSCI 2570 Machine Architecture and Organization	4
Subtotal	44

General Education Requirements Cr

Refer to the Minnesota Transfer Curriculum Course List for each Goal Area

<input type="checkbox"/> Goal 1: Communication	7
ENGL 1711 Composition 1 – 4 cr	
COMM 17XX – 3 cr	
<input type="checkbox"/> Goal 3 or Goal 4	3
Goal 3: Natural Sciences OR	
Goal 4: Mathematical/Logical Reasoning	
<input type="checkbox"/> Goal 5: History, Social Science and Behavioral Sciences	3
<input type="checkbox"/> Goal 6: Humanities and Fine Arts	3
General Education Requirements	16

Total Program Credits 60

Program Start Dates

Fall, Spring, Summer

Course Sequence

The following sequence is recommended for a full-time student. Not all courses are offered each semester.

First Semester

CSCI 1410 Computer Science & Information Systems	4
CSCI 1423 Computer Networking 1 – Client	4
CSCI 1440 Networking Fundamentals	4
Goal 1: ENGL 1711 Composition 1	4
Total Semester Credits	16

Second Semester

CSCI 1523 Intro to Computing and Programming Concepts	4
CSCI 2451 Computer Networking 2 – Server	4
CSCI 2461 Computer Networking 3 – Linux	4
CSCI 2475 A+ Hardware/Operating System Prep	4
Total Semester Credits	16

Third Semester

CSCI 2453 Computer Virtualization	4
Goal 1: COMM 17XX	3
Goal 3: Natural Science	
OR Goal 4: Mathematical/Logical Reasoning.	3
(MATH 1730 or proficiency required)	
Goal 5: History, Social and Behavioral Sciences	3
Goal 6: Humanities and Fine Arts	3
Total Semester Credits	16

Fourth Semester

CSCI 2420 Computer Security	4
CSCI 2465 Computer Networking 4 – Infrastructure	4
CSCI 2570 Machine Architecture and Organization	4
Total Semester Credits	12

Total Program Credits 60

See back of this guide for Transfer Opportunities

*Information is subject to change.
This Program Requirements Guide is not a contract.*

Computer Network Engineering AAS DEGREE *(continued)*

(44 credits + 16 GenEd credits)

Transfer Opportunities

Saint Paul College has a transfer articulation agreement between the following program and post-secondary institution for the baccalaureate degree program listed below.

For more information please go to saintpaul.edu/Transfer.

Computer Network Engineering AAS

BA	Individualized Studies Metropolitan State University	BS	Information Technology Saint Mary's University, Twin Cities Campus
BS	Computer Information Systems College of St. Scholastica	BS	Operations Management Minnesota State University, Moorhead

Minimum Program Entry Requirements

Students entering this program must meet the following minimum program entry requirements:

Reading: Score of 78+ or grade of "C" or better in READ 0722

Writing: Score of 78+ or grade of "C" or better in ENGL 0922

College Level Mathematics: Score of 50+ or grade of "C" or better in MATH 0920

Assessment Results and Prerequisites: Students admitted into Saint Paul College programs may need to complete additional courses based on assessment results and course prerequisite requirements. Certain MATH, READ, and ENGL courses have additional prerequisites.

037A (7035)

The below chart illustrates the courses required for completion of this degree.

Introductory

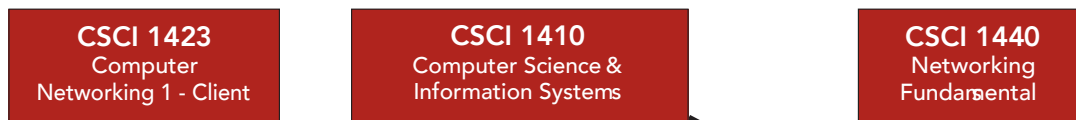

Intermediate

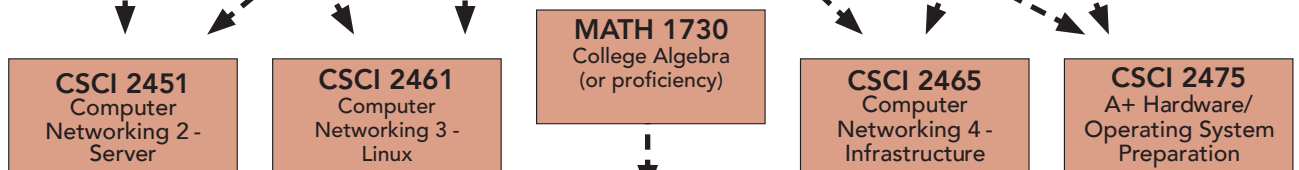

Advanced

(offered once per year)

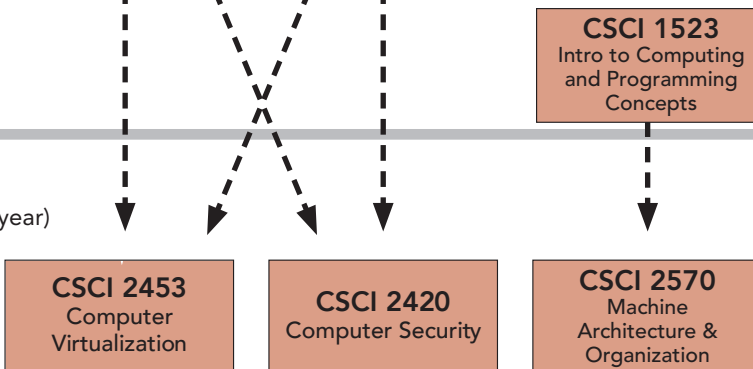

Computer Programming AAS DEGREE

Program Overview

The job of the applications programmer is to (1) review job specifications provided by the system analyst and end user and (2) plan, code, test, and document a programming solution which takes the available data input and produces the desired output in the form of a printed report or a screen display. The programming language(s) used depends on the nature of the problem and the languages available during installation.

Above average communications and math skills are required. Students should exhibit qualities of patience, perseverance and preciseness and should enjoy working in a team environment and also be able to work independently.

Career Opportunities

Graduates find excellent opportunities as computer programmers in business, manufacturing, government and education. Jobs for computer programmers for all types of computer systems are found throughout the country with opportunities for good earning and rapid advancement. Jobs include: Programmer, Database Project Specialist, Applications Programmer, Technical Programmer, Systems Analyst, MIS Coordinator, Software Developer, Junior Programmer-Analyst, and Senior Programmer-Analyst.

Program Outcomes

Graduates will be able to

1. Design and code computer programming in a variety in a variety computer-programming languages.
2. Professionally structure and document source codes.
3. Utilize sound program testing procedures to insure the accuracy of the programs they develop.
4. Use current program coding conventions to develop well documented code.
5. Apply technical communication skills.

Program Faculty

Warren Sheaffer
warren.sheaffer@saintpaul.edu

Program Requirements

Check off when completed

Course	Cr
<input type="checkbox"/> CSCI 1410 Computer Science & Information Systems	4
<input type="checkbox"/> CSCI 1423 Computer Networking – Client	4
<input type="checkbox"/> CSCI 1450 Web Fundamentals/HTML	4
<input type="checkbox"/> CSCI 1523 Intro to Computing and Programming Concepts	4
<input type="checkbox"/> CSCI 1524 Intro to Algorithms and Data Structures	4
<input type="checkbox"/> CSCI 1541 Java Programming 1	4
<input type="checkbox"/> CSCI 2570 Machine Architecture and Organization	4
Subtotal	28

Complete one of the Emphases listed below 16

Java Program Emphasis	Cr
<input type="checkbox"/> CSCI 1542 Java Programming 2	4
<input type="checkbox"/> CSCI 1550 Database Management Fundamentals	4
<input type="checkbox"/> CSCI 2440 Client Side Programming I	4
<input type="checkbox"/> CSCI 2466 J2EE-JSP and Servlets	4
Total Emphasis Credits	16

Web Development Emphasis Cr

<input type="checkbox"/> CSCI 2440 Client Side Programming 1	4
<input type="checkbox"/> CSCI 2442 Server Side Programming	4
<input type="checkbox"/> CSCI 2466 J2EE-JSP and Servlets	4
<input type="checkbox"/> CSCI 2622 Client Side Programming 2	4
Total Emphasis Credits	16

Web Based 2D Game Development Emphasis Cr

<input type="checkbox"/> DGIM 2521 2D Web Animation	2
<input type="checkbox"/> DGIM 2530 Web Based Game Design 1	4
<input type="checkbox"/> DGIM 2531 Web Based Game Design 2	4
<input type="checkbox"/> DGIM 2586 Digital Sound	2
<input type="checkbox"/> DGIM Technical Electives	4
<input type="checkbox"/> DGIM 1490 3D Animation Fundamentals	4
<input type="checkbox"/> DGIM 2560 Illustrator	4
<input type="checkbox"/> DGIM 1483 Photoshop 1	2
<input type="checkbox"/> DGIM 1484 Photoshop 2	2
Total Emphasis Credits	16

General Education Requirements Cr

Refer to the Minnesota Transfer Curriculum Course List for each Goal Area

<input type="checkbox"/> Goal 1: Communication	7
ENGL 1711 Composition 1 – 4 cr	
COMM 17XX – 3 cr	
<input type="checkbox"/> Goal 3 or Goal 4	3
Goal 3: Natural Sciences	
OR Goal 4: Mathematical/Logical Reasoning (MATH 1730 or proficiency required)	

- Goal 5: History, Social Science and Behavioral Sciences 3
- Goal 6: Humanities and Fine Arts 3
- General Education Requirements 16**

Total Program Credits 60

The following courses are not offered every semester.

Fall Semester Only

- CSCI 1542 Java Programming 2
- CSCI 2442 Server Side Programming
- CSCI 2622 Client Side Programming 2
- DGIM 1490 3D Animation Fundamentals
- DGIM 2530 Web Based Game Design 1
- DGIM 2560 Illustrator
- DGIM 2586 Digital Sound

Spring Semester Only

- CSCI 2440 Client Side Programming 1
 - CSCI 2466 J2EE-JSP and Servlets
 - DGIM 2521 2D Web Animation
 - DGIM 2531 Web Based Game Design 2
- All other courses are offered both fall and spring semester pending course enrollment. CSCI 1410, CSCI 1550, and General Education requirements are offered in the fall, spring, and summer.

See back of this guide for Course Sequence, Transfer Opportunities & Course Chart

Information is subject to change.
This Program Requirements Guide is not a contract.

Minimum Program Entry Requirements
Students entering this program must meet the following minimum program entry requirements:

Reading: Score of 78+ or grade of "C" or better in READ 0722

Writing: Score of 78+ or grade of "C" or better in ENGL 0922

College Level Mathematics: Score of 50+ or grade of "C" or better in MATH 0920

Assessment Results and Prerequisites:
Students admitted into Saint Paul College programs may need to complete additional courses based on assessment results and course prerequisite requirements. Certain MATH, READ, and ENGL courses have additional prerequisites.

009A (7011)

Computer Programming AAS DEGREE *(continued)*

(44 credits + 16 GenEd credits)

Program Start Dates

Fall, Spring, Summer

Course Sequence

The following sequence is recommended for a full-time student; however, this sequence is not required. Not all courses are offered each semester.

First Semester

- CSCI 1410 Computer Science & Information Systems 4
- CSCI 1423 Computer Networking – Client 4
- CSCI 1450 Web Fundamentals/HTML 4
- Goal 3: Natural Sciences OR
- Goal 4: Mathematical/Logical Reasoning 3
(MATH 1730 or proficiency required)
- Total Semester Credits 15**

Second Semester

- CSCI 1523 Intro to Computing and Programming Concepts 4
- Goal 1: ENGL 1711 Composition 1 4
- Emphasis Course 4
- CSCI 1541 Java Programming I 4
- Total Semester Credits 16**

Third Semester

- CSCI 1524 Intro to Algorithms and Data Structures . . . 4
- Goal 1: COMM 17XX 3
- Emphasis Course(s) 8
- Total Semester Credits 15**

Fourth Semester

- CSCI 2570 Machine Architecture and Organization . . . 4
- Goal 5: History, Social and Behavioral Sciences 3
- Goal 6: Humanities and Fine Arts 3
- Emphasis Course(s) 4
- Total Semester Credits 14**

Total Program Credits 60

Transfer Opportunities

Saint Paul College has a transfer articulation agreement between the following program and post-secondary institution for the baccalaureate degree program listed below.

For more information please go to saintpaul.edu/Transfer.

Computer Programming AAS

- BA Individualized Studies
Metropolitan State University
- BS Computer Information Systems
College of St. Scholastica
- BS Information Technology
Saint Mary's University,
Twin Cities Campus
- BS Operations Management
Minnesota State University, Moorhead

The below chart illustrates the courses required for completion of this degree.

Introductory

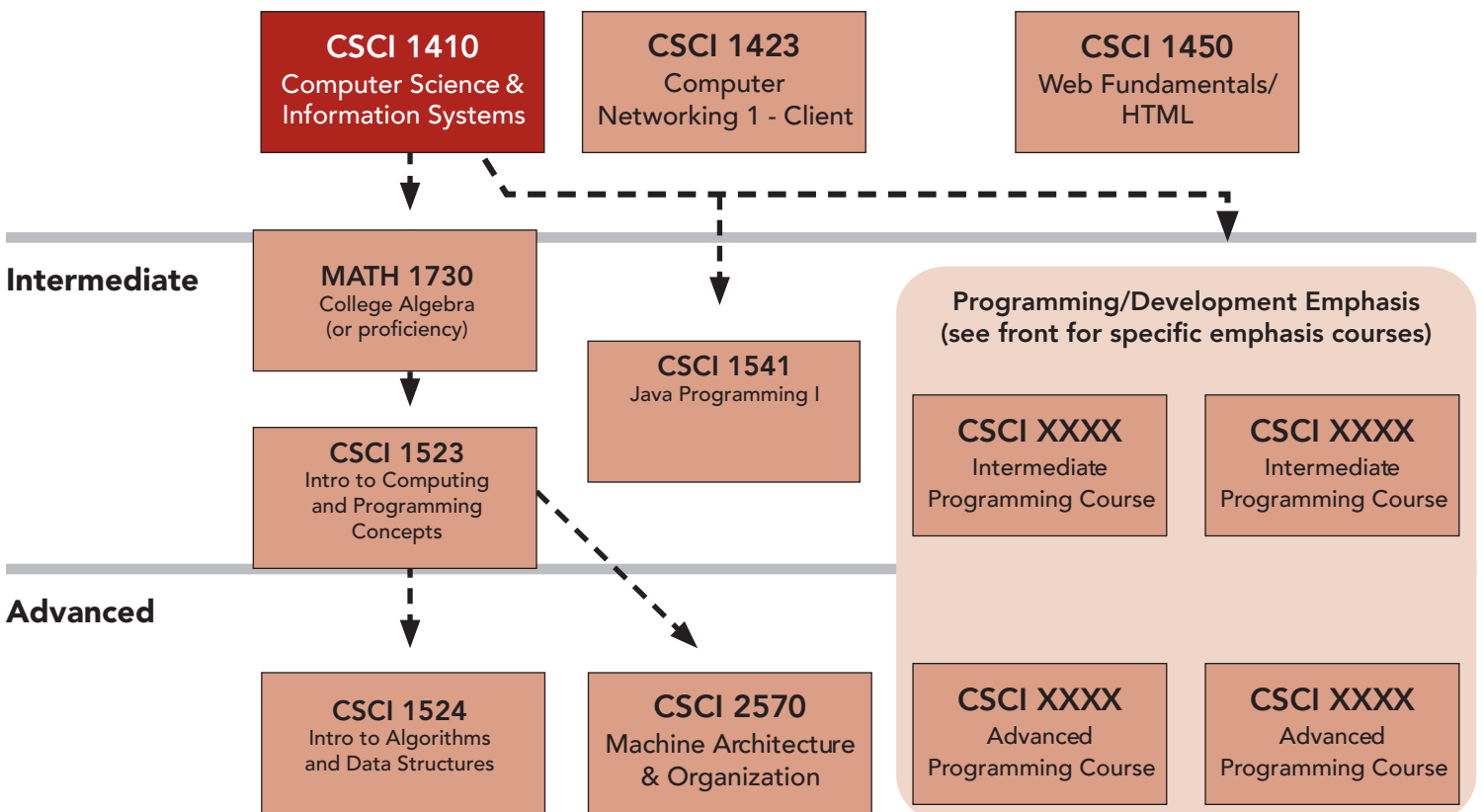

Network Administration CERTIFICATE

Program Overview

The Network Administration Certificate is designed for individuals who already have acquired at least a minimum level of technical computer skills, either through previous education, training, and/or experience. It is designed to enhance one's current computer knowledge and skills.

Networking Specialists can work in a wide variety of jobs. The work could include purchasing, installing, configuring, administrating, and/or supporting. Some jobs in networking could include help desk support, user training, installing and maintaining local and/or wide area networks.

The student should have excellent communications and math skills. For the certificate programs the student is expected to have prior microcomputer and/or networking experience. He/she should exhibit qualities of patience, perseverance, and preciseness and be a logical thinker. The student should enjoy working in a team environment, and be able to work independently. All networking programs emphasize preparation for either the Microsoft Certified System Administration or Linux Professional Institute (LPI) Certification.

Career Opportunities

With almost every size company connected to some type of network, the jobs in networking have become the fastest growing jobs in the computer field. With companies networking to share resources and reduce expenses the networking specialist is an invaluable part of the new company structure. There is a wide variety of jobs in networking including installation, maintenance, training, managing and user support.

Graduates find excellent opportunities as Network Administrators, Network Support, and Certified Network Engineers in business, manufacturing, government and education. Jobs for Networking Specialists for all types of installations are found throughout the country with opportunities for excellent earnings and rapid advancement. Jobs include the following:

- Networking Engineer
- Network Help Desk Support
- Data Communications Specialist
- PC Network Administrator
- Information Specialist
- WAN Manager
- Network Administrator
- LAN Specialist
- Telecommunications Specialist
- Certified Network Engineer
- LAN Manager

Program Outcomes

1. Graduates will have knowledge and skills in computer network engineering.
2. Graduates will have knowledge and experience in computer network system design, analysis, and maintenance.
3. Graduates of the Computer Network Programs will be prepared for employment as computer network engineers.

Program Faculty

Warren Sheaffer
warren.sheaffer@saintpaul.edu

Program Requirements

Check off when completed

Course	Cr
<input type="checkbox"/> CSCI 1410 Computer Science & Information Systems	4
<input type="checkbox"/> CSCI 1423 Computer Networking 1 – Client	4
<input type="checkbox"/> CSCI 1440 Networking Fundamentals	4
<input type="checkbox"/> CSCI 2451 Computer Networking 2 – Server	4
<input type="checkbox"/> CSCI 2461 Computer Networking 3 – Linux	4
<input type="checkbox"/> CSCI 2465 Computer Networking 4 – Infrastructure	4
Total Program Requirements	24

*Information is subject to change.
This Program Requirements Guide is not a contract.*

Program Start Dates

Fall, Spring, Summer

Course Sequence

The following sequence is recommended for a part-time student. Not all courses are offered each semester.

First Semester

CSCI 1410 Computer Science & Information Systems	4
CSCI 1440 Networking Fundamentals	4
Total Semester Credits	8

Second Semester

CSCI 1423 Computer Networking 1 – Client	4
CSCI 2465 Computer Networking 4 – Infrastructure	4
Total Semester Credits	8

Third Semester

CSCI 2451 Computer Networking 2 – Server	4
CSCI 2461 Computer Networking 3 – Linux	4
Total Semester Credits	8

Total Program Credits 24

See back of this guide for Course Chart

Minimum Program Entry Requirements

Students entering this program must meet the following minimum program entry requirements in addition to having acquired previous technical computer skills:

Reading: Score of 78+ or grade of "C" or better in READ 0722

Writing: Score of 78+ or grade of "C" or better in ENGL 0922

Elementary Algebra: Score of 76+ or grade of "C" or better in MATH 0910

Assessment Results and Prerequisites: Students admitted into Saint Paul College programs may need to complete additional courses based on assessment results and course prerequisite requirements. Certain MATH, READ, and ENGL courses have additional prerequisites.

298C (7183)

Network Administration CERTIFICATE *(continued)*
(24 credits)

The below chart illustrates the courses required for completion of this certificate.

Introductory

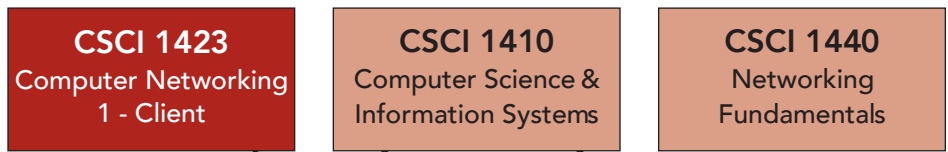

Intermediate



Java Programming CERTIFICATE

Program Overview

This is a 24 credit certificate program exploring the Java programming language and computing platform. The certificate includes a foundation course in computer science, a web fundamentals course, and an in depth study of databases. It then features a two-course sequence in Java programming and a course in Java for web development. This certificate may be completed apart from a degree program or may be selected as an emphasis in the Computer Programming AAS degree.

The student should have above average communications and math skills. He/she should exhibit qualities of patience, perseverance, and preciseness, and should enjoy working in a team environment and also be able to work independently. All programs emphasize training for industry certification.

Career Opportunities

Graduates find excellent opportunities as computer programmers in business, manufacturing, government and education. Jobs for computer programmers for all types of computer systems are found throughout the country with opportunities for good earning and rapid advancement.

Program Outcomes

1. Graduates will be able to design and code production software applications.
2. Graduates will be able to use industry standard database management systems to support their applications.

Program Faculty

Warren Sheaffer
warren.sheaffer@saintpaul.edu

Program Requirements

Check off when completed

This program is designed for individuals who have computer programming knowledge or are currently employed in the computer programming field.

Course	Cr
<input type="checkbox"/> CSCI 1410 Computer Science & Information Systems	4
<input type="checkbox"/> CSCI 1450 Web Fundamentals/HTML	4
<input type="checkbox"/> CSCI 1541 Java Programming 1	4
<input type="checkbox"/> CSCI 1542 Java Programming 2	4
<input type="checkbox"/> CSCI 1550 Database Management Fundamentals	4
<input type="checkbox"/> CSCI 2466 J2EE-JSP and Servlets	4
Total Program Credits	24

Program Start Dates

Fall, Spring, Summer

Course Sequence

The following sequence is recommended for a part-time student. Not all courses are offered every semester. Please contact the Program Faculty for course sequence.

First Semester

CSCI 1410 Computer Science & Information Systems	4
CSCI 1450 Web Fundamentals/HTML	4
Total Semester Credits	8

Second Semester

CSCI 1541 Java Programming 1	4
CSCI 1550 Database Management Fundamentals	4
Total Semester Credits	8

Third Semester

CSCI 1542 Java Programming 2	4
CSCI 2466 J2EE-JSP and Servlets	4
Total Semester Credits	8

Total Program Credits 24

See back of this guide for Course Chart

Minimum Program Entry Requirements

Students entering this program must meet the following minimum program entry requirements:

Reading: Score of 78+ or grade of "C" or better in READ 0722

Writing: Score of 78+ or grade of "C" or better in ENGL 0922

Elementary Algebra: Score of 76+ or grade of "C" or better in MATH 0910

Assessment Results and Prerequisites: Students admitted into Saint Paul College programs may need to complete additional courses based on assessment results and course prerequisite requirements. Certain MATH, READ, and ENGL courses have additional prerequisites.

299C (7177)

*Information is subject to change.
This Program Requirements Guide is not a contract.*

Java Programming CERTIFICATE *(continued)*
 (24 credits)

The below chart illustrates the courses required for completion of this certificate.

Introductory



Intermediate



Advanced

(offered once per year)

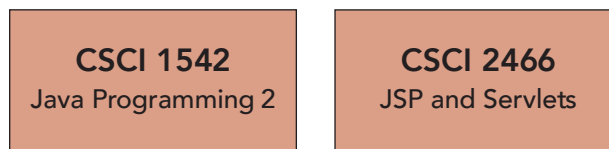

Web Based 2D Game Development CERTIFICATE

Program Overview

This is a 24 credit certificate program exploring video game creation. The certificate is ideal for students who want to acquire skills needed for game design and programming. The certificate will utilize HTML5, Javascript, Tumult Hype and Phoneygap to recreate classic video games for both the Desktop and mobile platforms. The capstone class will introduce students to some of the concepts of mobile app development for both the iPhone and Android platforms. This certificate may be completed apart from a degree program or may be selected as an emphasis in the Computer Programming AAS degree.

The student should have above average communications and math skills. He/she should exhibit qualities of patience, perseverance, and preciseness, and should enjoy working in a team environment and also be able to work independently. All programs emphasize training for industry certification.

Career Opportunities

Graduates find excellent opportunities as computer programmers in business, manufacturing, government and education. Jobs for computer programmers for all types of computer systems are found throughout the country with opportunities for good earning and rapid advancement.

Program Outcomes

1. Graduates will be able to design and code gaming software applications.
2. Graduates will be able to use industry standard design skills to support their applications

Program Faculty

Darren Pearson darren.pearson@sainpaul.edu

Program Requirements

Check off when completed

This program is designed for individuals who have computer programming knowledge or are currently employed in the computer programming field.

Course	Cr
<input type="checkbox"/> CSCI 1450 Web Fundamentals/HTML	4
<input type="checkbox"/> CSCI 2440 Client Side Programming 1	4
<input type="checkbox"/> DGIM 2521 2D Web Animation	2
<input type="checkbox"/> DGIM 2530 Web Based Game Design 1	4
<input type="checkbox"/> DGIM 2531 Web Based Game Design 2	4
<input type="checkbox"/> DGIM 2586 Digital Sound	2
<input type="checkbox"/> DGIM Technical Elective(s)	4
Any 4 credits of DGIM classes will be allowed, although the following classes are recommended.	
DGIM 1483 Photoshop 1 - 2cr	
DGIM 1484 Photoshop 2 - 2cr	
DGIM 1490 3D Animation Fundamentals - 4cr	
DGIM 2560 Illustrator - 4cr	

Total Program Credits24

Program Start Dates

Fall, Spring, Summer

Course Sequence

The following sequence is recommended for a part-time student. Not all courses are offered every semester. Please contact the Program Faculty for course sequence.

First Semester

CSCI 1450 Web Fundamentals/HTML	4
DGIM 2521 2D Web Animation	2
Total Semester Credits.	6

Second Semester

CSCI 2440 Client Side Programming 1	4
DGIM Technical Electives	2
Total Semester Credits.	6

Third Semester

DGIM 2530 Web Based Game Design 1	4
DGIM Technical Electives	2
Total Semester Credits.	6

Fourth Semester

DGIM 2531 Web Based Game Design 2	4
DGIM 2586 Digital Sound	2
Total Semester Credits.	6

Total Program Credits24

See back of this guide for Course Chart

Minimum Program Entry Requirements

Students entering this program must meet the following minimum program entry requirements:

Reading: Score of 78+ or grade of "C" or better in READ 0722

Writing: Score of 78+ or grade of "C" or better in ENGL 0922

Elementary Algebra: Score of 76+ or grade of "C" or better in MATH 0910

Assessment Results and Prerequisites:

Students admitted into Saint Paul College programs may need to complete additional courses based on assessment results and course prerequisite requirements. Certain MATH, READ, and ENGL courses have additional prerequisites.

379C

*Information is subject to change.
This Program Requirements Guide is not a contract.*

Web Based 2D Game Development CERTIFICATE *(continued)* (24 credits)

The below chart illustrates the courses required for completion of this certificate.

Introductory

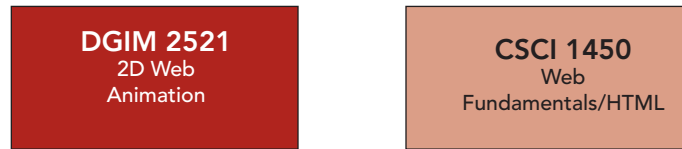

Intermediate

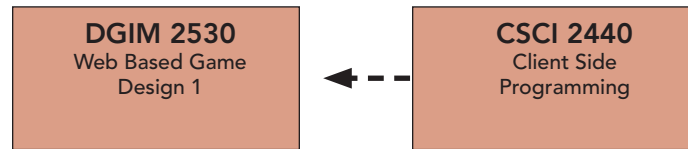

Advanced

(offered once per year)

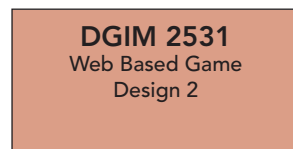

Web Development CERTIFICATE

Program Overview

This is a 24 credit certificate program providing a foundation in current web technologies. It features a two course sequence in client side programming including AJAX, and also coverage of at least two current server side technologies for database driven development. It includes popular technologies like Ruby on Rails and JSP/Servlets. This certificate may be completed apart from a degree program or may be selected as an emphasis in the Computer Programming AAS degree.

Career Opportunities

Graduates find excellent opportunities as computer programmers in business, manufacturing, government and education. Jobs for computer programmers for all types of computer systems are found throughout the country with opportunities for good earning and rapid advancement.

Program Outcomes

1. Graduates will be able to design and code production web applications based on standard client and server side technologies.
2. Graduates will be able to use industry standard database management systems to support their applications.

Program Faculty

Darren Pearson darren.pearson@sainpaul.edu

Program Requirements

Check off when completed

This program is designed for individuals who have computer programming knowledge or are currently employed in the computer programming field.

Course	Cr
<input type="checkbox"/> CSCI 1410 Computer Science & Information Systems	4
<input type="checkbox"/> CSCI 1450 Web Fundamentals/HTML	4
<input type="checkbox"/> CSCI 2440 Client Side Programming 1	4
<input type="checkbox"/> CSCI 2442 Server Side Programming	4
<input type="checkbox"/> CSCI 2466 J2EE-JSP and Servlets	4
<input type="checkbox"/> CSCI 2622 Client Side Programming 2	4

Total Program Credits 24

Program Start Dates

Fall, Spring, Summer

Course Sequence

The following sequence is recommended for a part-time student. Not all courses are offered every semester. Please contact the Program Faculty for course sequence.

First Semester

CSCI 1410 Computer Science & Information Systems	4
CSCI 1450 Web Fundamentals/HTML	4
Total Semester Credits	8

Second Semester

CSCI 2440 Client Side Programming 1	4
CSCI 2442 Server Side Programming	4
Total Semester Credits	8

Third Semester

CSCI 2466 J2EE-JSP and Servlets	4
CSCI 2622 Client Side Programming 2	4
Total Semester Credits	8

Total Program Credits 24

See back of this guide for Course Chart

*Information is subject to change.
This Program Requirements Guide is not a contract.*

Minimum Program Entry Requirements
Students entering this program must meet the following minimum program entry requirements:

Reading: Score of 78+ or grade of "C" or better in READ 0722

Writing: Score of 78+ or grade of "C" or better in ENGL 0922

Elementary Algebra: Score of 76+ or grade of "C" or better in MATH 0910

Assessment Results and Prerequisites:
Students admitted into Saint Paul College programs may need to complete additional courses based on assessment results and course prerequisite requirements. Certain MATH, READ, and ENGL courses have additional prerequisites.

244C (7117)

Web Development CERTIFICATE *(continued)*
 (24 credits)

The below chart illustrates the courses required for completion of this certificate.

Introductory

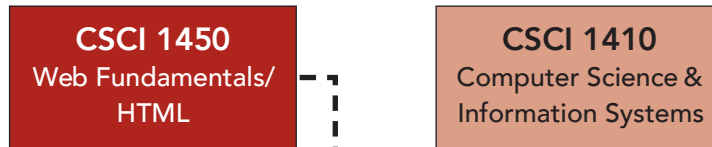

Intermediate

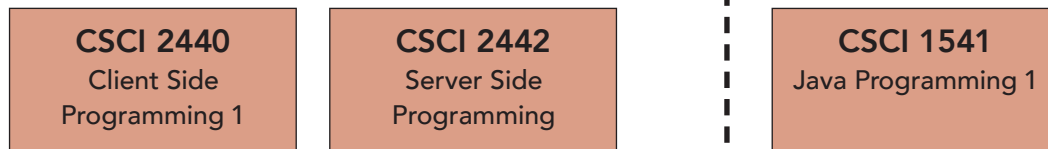

Advanced

(offered once per year)



Data Science AS DEGREE

Program Overview

Data Science uses the techniques and theories from many different fields of study including mathematics, statistics, computer science, and information theory. Data scientists sort through great amounts of unstructured data such as emails, videos, social media, and other user-generated content and write algorithms to extract insights from the data. In essence, they turn data into knowledge.

Students entering into this program of study will learn to collect, manage, interpret and analyze data in order to assist in making data-informed decisions for the benefit of a company or organization.

Career Opportunities

There is a growing need for individuals who have the skills to effectively collect and analyze data to make informed, data-driven decisions. Jobs for data scientists, business intelligence analysts, data mining analysts and other data science professions have emerged across all industries that use data extensively, including government, business, healthcare, online commerce and more.

Program Outcomes

1. Graduates will have knowledge and skills to understand big data and the challenges of capturing, storing and retrieving massive data.
2. Graduates will develop an understanding of the analytical and computational techniques used to analyze data for the purposes of providing meaning.
3. Graduates will be familiar with the foundations, frameworks and applications of the emerging field of data science.
4. Graduates of the Data Science program will be prepared for the application of data-based analytical approach to identify and solve problems.

Transfer Opportunities

Saint Paul College has a transfer articulation agreement between the following program and post-secondary institution for the baccalaureate degree program listed below. For more information please go to saintpaul.edu/Transfer.

Data Science AS

BA Individualized Studies
Metropolitan State University

Program Faculty

Warren Sheaffer warren.sheaffer@saintpaul.edu

Program Requirements

Check off when completed

Course	Cr
<input type="checkbox"/> CSCI 1410 Computer Science & Information Systems	4
<input type="checkbox"/> CSCI 1523 Intro to Computing and Programming Concepts	4
<input type="checkbox"/> CSCI 1524 Intro to Algorithms and Data Structures	4
<input type="checkbox"/> CSCI 1541 Java Programming 1	4
<input type="checkbox"/> CSCI 1550 Database Management Fundamentals	4
<input type="checkbox"/> CSCI 1714 Introduction to Data Science	4
<input type="checkbox"/> Technical Electives	6
Select from CSCI, GISC, MATH; the following are recommended:	
CSCI 1450 Web Fund/HTML - 4 cr	
CSCI 1544 Enterprise Op Systems – 4 cr	
CSCI 2470 Enterprise Database Systems – 4 cr	
GISC 1760 Intro to GIS – 4 cr	
GISC 1765 Cartography – 3 cr	
GISC 2730 Programming and Scripting in GIS – 4 cr	
MATH 2749 Calculus 1 – 4 cr	
Subtotal	30

General Education/MnTC Requirements

General Education/MnTC Requirements	Cr
Refer to the Minnesota Transfer Curriculum Course List for each Goal Area	
<input type="checkbox"/> Goal 1: Communication	7
ENGL 1711 Composition 1 – 4 cr	
COMM 17XX – 3 cr	
<input type="checkbox"/> Goal 4: Mathematical/Logical Reasoning	11
MATH 1740 Introduction to Statistics – 4 cr	
MATH 2100 Intermediate Statistics – 4 cr	
PHIL 1710 Logic – 3 cr	
<input type="checkbox"/> Goal 5: History, Social Science and Behavioral Sciences	3
ECON 1720 Macroeconomics – 3 cr OR	
ECON 1730 Microeconomics – 3 cr	
<input type="checkbox"/> Goal 6: Humanities & Fine Arts	3
PHIL 1720 Ethics – 3 cr	
<input type="checkbox"/> Goals 1-10 of the Minnesota Transfer Curriculum	6
Students must select a minimum of 5 additional credits such that courses from at least six (6) goal areas of the Minnesota Transfer Curriculum are met.	
General Education Requirements	30

Total Program Credits 60

*Information is subject to change.
This Program Requirements Guide is not a contract.*

Program Start Dates

Fall, Spring, Summer

Course Sequence

This course sequence is recommended for a full-time student; however, this sequence is not required. Not all courses are offered each semester; a selection of courses is offered summer term. Students should consult with the Program Faculty each semester.

First Semester

CSCI 1410 Computer Science & Information Systems	4
Goal 1: ENGL 1711 Composition 1	4
Goal 1: COMM 17XX	3
Goal 4: PHIL 1710 Logic	3
Total Semester Credits	14

Second Semester

CSCI 1523 Intro to Computing and Programming Concepts	4
CSCI 1550 Database Management	4
Goal 4: MATH 1740 Introduction to Statistics	4
Goal 5: ECON 1720 Macroeconomics OR ECON 1730 Microeconomics	3
Total Semester Credits	15

Third Semester

CSCI 1541 Java Programming 1	4
CSCI 1714 Introduction to Data Science	4
Goal 4: MATH 2100 Intermediate Statistics	4
Goal 6: PHIL 1720 Ethics	3
Total Semester Credits	15

Fourth Semester

CSCI 1524 Intro to Algorithms and Data Structures	4
Technical Electives	6
MnTC Electives	6
Total Semester Credits	16
Total Program Credits	60

Minimum Program Entry Requirements

Students entering this program must meet the following minimum program entry requirements:

Reading: Score of 78+ or grade of "C" or better in READ 0722

Writing: Score of 78+ on Reading Comprehension or grade of "C" or better in ENGL 1415

College Level Math: Score of 50+ or grade of "C" or better in MATH 0920

Assessment Results and Prerequisites: Students admitted into Saint Paul College programs may need to complete additional courses based on assessment results and course prerequisite requirements. Certain MATH, READ, and ENGL courses have additional prerequisites. 389S (7226)

Geographic Information Science AAS DEGREE

Program Overview

GIS is an acronym for Geographic Information Science. The GIS Associate of Applied Science degree will prepare students for entry level positions in various industries that require geospatial skills and thinking or for transitioning to four-year baccalaureate programs. Students completing this degree will be able to create and import digital special data representing real-world features from the surface of the Earth with the goal of viewing, manipulating, and analyzing the data to be distributed and used in decision making.

Duties for many positions requiring GIS skills typically involve a combination of outside field work and indoor computer work. While outside, raw spatial data is often collected with GPS devices for a variety of features. Some examples include the location of trees, fountains, utility poles, underground pipelines, soil sample sites, endangered species, and more. The working environment may be in a dense urban area or remote national park, depending on the employer. While inside, digital special data are imported from your GPS devices into a computer where the data is assessed for quality and revised/manipulated if necessary. Remotely sensed data from various sensors and online archives may also be used to generate additional information. GIS employees typically coordinate with other experts (e.g. geologists, business operations specialists, hydrologists, farmers, and urban planners) to discuss the scientific and managerial implications of their work.

Career Opportunities

There are abundant opportunities for employment as a GIS Analyst, GIS Technician, or GIS Specialist in a wide variety of businesses, universities, government agencies, and non-profit organizations. Employees with strong GIS skills are highly coveted in the oil and gas industry, biological and environmental sciences research, natural resource management, government agencies focus on mapping and analyzing infrastructure, intelligence collection by federal agencies, and various business groups. GIS professionals also have ample opportunity to advance into more highly-skilled positions or managerial and leadership positions.

Program Outcomes

1. Graduates will possess fundamental and applied skills in GIS such as making maps, working with rasters and vectors, geometric accuracy, georeferencing, map projections, spatial analysis, Boolean logic, scripting, remote sensing, air photo interpretation, etc.
2. Graduates will develop a working knowledge of the most popular GIS software, ArcGIS from ESRI.
3. Graduates will develop a working knowledge of GPS devices used by a multitude of businesses and government agencies.

Program Faculty

Kirk Stueve kirk.stueve@saintpaul.edu

Program Requirements

Check off when completed

Course	Cr
<input type="checkbox"/> GISC 1760 Introduction to GIS.	4
<input type="checkbox"/> GISC 1765 Cartography	3
<input type="checkbox"/> GISC 1770 Spatial Thinking	3
<input type="checkbox"/> GISC 1775 Intro to Remote Sensing	4
<input type="checkbox"/> GISC 1780 Spatial Analysis.	3
<input type="checkbox"/> GISC 1785 GPS Field Techniques.	3
<input type="checkbox"/> GISC 2720 Web-based GIS	3
<input type="checkbox"/> GISC 2725 Object-based Image Analysis.	3
<input type="checkbox"/> GISC 2730 Programming and Scripting in GIS.	4
Subtotal.	30

General Education/MnTC Requirements

General Education/MnTC Requirements	Cr
Refer to the Minnesota Transfer Curriculum Course List for each Goal Area	
<input type="checkbox"/> Goal 1: Communication	7
ENGL 1711 Composition 1 – 4 cr	
COMM 17XX – 3 cr	
<input type="checkbox"/> Goal 3: Natural Sciences	4
BIOL 1725 Environmental Science	
<input type="checkbox"/> Goal 4: Mathematical/Logical Reasoning.	4
MATH 1740 Introduction to Statistics	
<input type="checkbox"/> Goal 5: History, Social Science and Behavioral Sciences	3
GEOG 1700 Physical Geography	
<input type="checkbox"/> Goal 6: Humanities and Fine Arts.	3
<input type="checkbox"/> Goals 1-10 of the Minnesota Transfer Curriculum	9
General Education Requirements	30

Total Program Credits 60

Transfer Opportunities

Saint Paul College has a transfer articulation agreement between the following program and post-secondary institution for the baccalaureate degree program listed below. For more information please go to saintpaul.edu/Transfer.

Geographic Information Science AAS

BA Individualized Studies
Metropolitan State University

*Information is subject to change.
This Program Requirements Guide is not a contract.*

Program Start Dates

Fall, Spring, Summer
– only General Education courses & GISC 1785

Course Sequence

Not all courses are offered each semester; a selection of courses is offered summer term. Students should consult with the Program Faculty each semester.

First Semester

GISC 1760 Introduction to GIS	4
GISC 1765 Cartography	3
GISC 1770 Spatial Thinking.	3
Goal 1: COMM 17XX	3
Goal 5: GEOG 1700 Physical Geography	3
Total Semester Credits.	16

Second Semester

GISC 1775 Intro to Remote Sensing.	4
GISC 1780 Spatial Analysis	3
GISC 1785 GPS Field Techniques (summer only)	3
Goal 4: MATH 1740 Introduction to Statistics	4
Total Semester Credits.	14

Third Semester

GISC 2720 Web-based GIS.	3
GISC 2725 Object-based Image Analysis	3
Goal 1: ENGL 1711 Composition 1.	4
Goal 6: Humanities and Fine Arts	3
MnTC Elective	3
Total Semester Credits.	16

Fourth Semester

GISC 2730 Programming and Scripting in GIS.	4
Goal 3: BIOL 1725 Environmental Science	4
MnTC Elective	6
Total Semester Credits.	14
Total Program Credits	60

Minimum Program Entry Requirements

Students entering this program must meet the following minimum program entry requirements:

Reading: Score of 78+ or grade of "C" or better in READ 0722

Writing: Score of 78+ on Reading Comprehension or grade of "C" or better in ENGL 0922

College Level Math: Score of 50+ or grade of "C" or better in MATH 0920

Assessment Results and Prerequisites: Students admitted into Saint Paul College programs may need to complete additional courses based on assessment results and course prerequisite requirements. Certain MATH, READ, and ENGL courses have additional prerequisites.

385A (7214)

Geographic Information Science CERTIFICATE

Program Overview

In order to be admitted to the Geographic Information Science certificate program, the student must have completed an associate degree or baccalaureate degree, or receive instructor approval if currently pursuing an associate degree in another discipline.

The Geographic Information Science certificate program is designed to introduce students to fundamental concepts in GIS and prepare them for entry level positions in various industries that require some knowledge and understanding of GIS. Students completing the GIS certificate program will learn how to solve problems and support the decision making process by collecting, viewing, manipulating, and mapping digital spatial data. There will be ample opportunities in the classes for students to pursue independent GIS projects related to their interests.

Career Opportunities

Duties for most positions requiring skills obtained from the GIS Certificate program are highly variable. Some employees spend much of their time working in an office with cutting-edge GIS software, but others are outside in the field most of the time providing support for data collection activities. For instance, in a retail setting, employees may provide technical insight for modeling the most appropriate location of new stores based on a variety of variables such as distance to existing stores, population density, and demographics. In an environmental science setting, employees may identify and map locations of invasive species or provide support in developing a watershed analysis geared to improve water quality.

Most employment opportunities relevant to the GIS Certificate will be listed under a wide range of specialties in various sectors (e.g., environment field technician, business support analyst, computer programmer, etc.) where GIS is not mentioned in the title, but is a preferred skill. The opportunity you are best suited for will be shaped by your previous and ongoing education and work experience.

Program Outcomes

1. Basic skills for working with digital spatial data in a GIS environment. This includes a fundamental understanding of rasters, vectors, map projections, coordinate systems, and cartography.
2. Solid understanding of ArcGIS from ESRI.
3. Working knowledge of Trimble GPS units.

Program Faculty

Kirk Stueve kirk.stueve@saintpaul.edu

Program Requirements

Check off when completed

Course	Cr
<input type="checkbox"/> GISC 1760 Introduction to GIS.	4
<input type="checkbox"/> GISC 1765 Cartography	3
<input type="checkbox"/> GISC 1770 Spatial Thinking	3
<input type="checkbox"/> GISC 1785 GPS Field Techniques.	3
Subtotal	13
Total Program Credits	13

Program Start Dates

Fall, Spring, Summer
– only GISC 1785

Course Sequence

Not all courses are offered each semester; a selection of courses is offered summer term.

Students should consult with the Program Faculty each semester.

Program is not eligible for financial aid.

First Semester

GISC 1760 Introduction to GIS	4
GISC 1765 Cartography	3
GISC 1770 Spatial Thinking.	3
GISC 1785 GPS Field Techniques (summer only)	3
Total Semester Credits	13

Total Program Credits **13**

Minimum Program Entry Requirements

Students entering this program must meet the following minimum program entry requirements:

Note: Students must have completed an Associate Degree or Baccalaureate degree or have instructor approval to be enrolled in this Certificate.

Assessment Results and Prerequisites:

Students admitted into Saint Paul College programs may need to complete additional courses based on assessment results and course prerequisite requirements. Certain MATH, READ, and ENGL courses have additional prerequisites.

385C (7225)

*Information is subject to change.
This Program Requirements Guide is not a contract.*

Liberal & Fine Arts Programs & Courses

Liberal & Fine Arts

Associate of Arts Degree (60 Credits)	207
Associate of Arts Degree – Emphasis in Criminology (60 Credits)	208
Emphasis in Social Science/Public Affairs (60 Credits)	209
Associate of Fine Arts Degree – Music (68 Credits)	210-211
American Sign Language Studies Certificate (30 Credits)	212-213
Also available: Sign Language Interpreter/Transliterators AAS Degree, page 167-168	
English for Academic Purposes (EAP) (30 Credits)	214
Communication Studies Transfer Pathway (60 Credits)	215
History Transfer Pathway (60 Credits)	216

Communications

English	217
Reading	217
Communication	217
English for Academic Purposes (EAP)	217

Fine Arts/Humanities

Art	218
Drama & Theatre	218
Humanities	218
Music	219
Philosophy	219

Global Languages

American Sign Language (ASL)	219
Chinese	220
Spanish	220

Social Science

Anthropology	221
Economics	221
Geography	221
History	221
Political Science	221
Psychology	222
Sociology	222
Women’s and Gender Studies	222

Associate of Arts DEGREE

Program Overview

The Associate of Arts (AA) degree is awarded for successful completion of 60 semester credits in liberal arts and sciences and is designed to constitute the first two years of a bachelor's degree. The AA degree is a liberal arts degree intended primarily for students who plan to transfer to another college or university to complete a bachelor's degree.

No specific major is listed in conjunction with the degree; however, students may choose to concentrate in a particular field of study in preparation for a planned major or professional emphasis at a four-year college or university.

An AA degree must include the entire Minnesota Transfer Curriculum (40 semester credits), which, pursuant to Minnesota statute, must transfer to any institution in the Minnesota State Colleges and Universities system or the University of Minnesota.

Students are to develop an educational plan in consultation with a Saint Paul College Pathway Advisor to assure that degree requirements are fulfilled. Requirements may vary depending upon the major and transfer college.

The AA degree can be completed through a variety of course delivery methods including face to face, hybrid and/or online. A student may choose to complete the entire AA degree online.

Program Outcomes

1. Knowledge of the important concepts and principles of the natural sciences, mathematics, history, social and behavioral sciences, arts, and humanities.
2. Skills necessary for life roles, including skills in thinking, communication and methods of inquiry and applications of knowledge.
3. Critical examination of and an appreciation for diverse people, cultures and life roles.

Program Advisors

Pathway Advisors are the Academic Advisors for the Associate of Arts degree and are located in the Advising Center, Room 1340, Main Floor.

For assistance or additional information, please call our Advising Center at 651.846.1739 or email: advising@saintpaul.edu.

*Information is subject to change.
This Program Requirements Guide is not a contract.*

Program Requirements

Check off when completed

Course Requirements Cr

Refer to the Minnesota Transfer Curriculum Course List for each of the ten Goal Areas

- Goal 1: Communication** 9
Minimum of 9 credit, including the following:
ENGL 1711 Composition 1 – 4 cr
ENGL 1712 Composition 2 – 2 cr
COMM 17XX – 3 cr
- Goal 2: Critical Thinking**
Fulfilled when 10 goal areas (40 credits) are completed
- Goal 3: Natural Sciences** 7
Minimum of two courses from two different disciplines, one of which must be a lab course.
- Goal 4: Mathematical/Logical Reasoning** 3
Minimum of one course. Courses must be numbered between 1700-1799 or 2700-2799.
- Goal 5: History, Social Sciences and Behavioral Sciences** 9
Minimum of three courses from two different disciplines.
- Goal 6: Humanities and Fine Arts** 9
Minimum of three courses from two different disciplines.
- MnTC Goal 7: Human Diversity**
Minimum of one course.
- MnTC Goal 8: Global Perspective**
Minimum of one course.
- MnTC Goal 9: Ethic and Civil Responsibility**
One eligible course.
- MnTC Goal 10: People and the Environment**
Minimum of one course.

Minnesota Transfer Curriculum (MnTC)	40
Goals 1-10:	40
Additional MnTC and/or pre-major electives	20
Total Program Credits	60

Additional Requirements

- At least 60 earned college-level credits (40 MnTC credits and 20 additional MnTC, pre-major or elective credits)
- A grade of "C" or better in ENGL 1711
- Associate of Arts (AA) cumulative GPA of 2.0
- Minnesota Transfer Curriculum (MnTC) cumulative GPA of 2.0
- Meet Saint Paul College residency requirement: 20 credits. This requirement may be reduced to 12 credits with transfer of at least 12 college-level credits from another Minnesota State College and University or the University of Minnesota

Minnesota Transfer Curriculum

Students completing the Minnesota Transfer Curriculum (MnTC) must take courses that satisfy the requirements for each of the 10 Goal Areas.

- A minimum of 40 credits is required.
- Credits are counted only once toward the MnTC 40-credit minimum even though a course may be listed in more than one goal area. Courses designated with a superscript satisfy more than one goal area, i.e., BIOL 172510.
- A discipline is a subject, e.g., "Biology," "Chemistry," and "Physics" are three different disciplines.

Check www.transferology.com to determine whether courses transfer as direct equivalents at the institution you plan to attend.

Using the MnTC Curriculum Guide

The MnTC Curriculum Guide is available online at saintpaul.edu/MnTC or you can pick one up in the Advising Center or in Enrollment Services.

On the guide, pay special attention to the following:

- A (p) listed after the course title indicates that a prerequisite is required before the course can be taken.
- An asterisk (*) after the course number indicates the course contains a lab.

Minimum Program Entry Requirements Students entering this program must meet the following minimum program entry requirements:

Reading: Score of 78+ or grade of "C" or better in READ 0722

Writing: Score of 78+ on Reading Comprehension or grade of "C" or better in ENGL 0922

Arithmetic: Score of 20+; Visit the Advising Center to determine if transfer programs require college-level math.

Assessment Results and Prerequisites: Students admitted into Saint Paul College programs may need to complete additional courses based on assessment results and course prerequisite requirements. Certain MATH, READ, and ENGL courses have additional prerequisites.

99AA (7095)

Associate of Arts DEGREE Emphasis in Criminology

Program Overview

The Associate of Arts Degree - Emphasis in Criminology provides students the opportunity to study specific types of crime, the theories of crime and punishment, the psychological and social origins of criminal behavior, and social value systems. Students will also examine criminal law and criminal justice systems, penology, rehabilitation, recidivism, social attitudes concerning crime and the justice system, and criminal justice policy.

Career Opportunities

Students who successfully complete the Associate of Arts Degree - Emphasis in Criminology will be prepared to transfer to a baccalaureate program in Criminal Justice. With a degree in criminal justice, you can work in a number of careers fields within the justice system such as court administrators, social workers, parole officers, correctional officers and management positions.

Program Outcomes

1. Apply knowledge of the important concepts and principles of the natural sciences, mathematics, history, social and behavioral sciences, arts, and humanities.
2. Develop skills necessary for life roles, including skills in thinking, communication, and methods of inquiry and applications of knowledge.
3. Critically examine and develop an appreciation for diverse people, cultures, and life roles.
4. Develop oral and written communication skills to communicate with a wide range of diverse populations.
5. Demonstrate an understanding of the fields of criminology and criminal justice and apply criminological theory to contemporary problems and issues.

Transfer Opportunities

Saint Paul College has a transfer articulation agreement between the following program and post-secondary institution for the baccalaureate degree program listed below.

For more information please go to saintpaul.edu/Transfer.

Associate of Arts Degree - Emphasis in Criminology

BA Criminal Justice

Metropolitan State University

*Information is subject to change.
This Program Requirements Guide is not a contract.*

Program Faculty

Kris D'Meier kris.dmeier@saintpaul.edu
Jolene Sundlie jolene.sundlie@saintpaul.edu

Program Requirements

Check off when completed

Emphasis Requirements	Cr
<input type="checkbox"/> SOCI 1765 Sociology of Crime and Deviance	3
<input type="checkbox"/> SOCI 1766 Juvenile Delinquency	3
<input type="checkbox"/> SOCI 1772 Intro to Criminal Justice	3
<input type="checkbox"/> Criminology Electives	11
Any MnTC course may be counted; however, the following are recommended:	
PHIL 1720 Ethics – 3 cr	
POLS 1720 Intro to American Government – 3 cr	
PSYC 1710 General Psychology – 4 cr	
PSYC 1740 Abnormal Psychology – 4 cr	
PSYC/SOCI 2720 Social Psychology – 4 cr	
SOCI 1710 Intro to Sociology – 4 cr	
SOCI 1720 Social Problems – 3 cr	
SOCI 1774 Intro to Corrections – 3 cr	
SOCI 1776 Probation, Parole and Alternative Sentencing – 3 cr	
Emphasis Total	20

MnTC Requirements	Cr
Refer to the Minnesota Transfer Curriculum Course List for each Goal Area	
<input type="checkbox"/> Goal 1: Communication	9
ENGL 1711 Composition 1 – 4 cr	
ENGL 1712 Composition 2 – 2 cr	
COMM 17XX – 3 cr	
<input type="checkbox"/> Goal 2: Critical Thinking	
<i>Fulfilled when 10 goal areas (40 credits) are completed.</i>	
<input type="checkbox"/> Goal 3: Natural Science	7
<i>Two courses from two different disciplines, one of which must be a lab course.</i>	
<input type="checkbox"/> Goal 4: Mathematical/Logical Reasoning	3
<i>One course numbered between 1700-1799 or 2700-2799.</i>	
MATH 1740 Introduction to Statistics (recommended) – 4 cr	
<input type="checkbox"/> Goal 5: History, Social Sciences and Behavioral Sciences	9
<i>Three courses from two different disciplines.</i>	
Emphasis courses SOCI 1765 – 3 cr and SOCI 1766 – 3 cr will count toward Goal 5.	
One additional non-SOCI course is required.	
<input type="checkbox"/> Goal 6: Humanities & Fine Arts	9
<i>Three courses from two different disciplines.</i>	
<input type="checkbox"/> Goal Areas 7-10	
<i>Select courses to meet all 10 Goal Areas</i>	
MnTC Requirements Total	40

Total Program Credits 60
If courses are counted in both the Emphasis Requirements and the MnTC Requirements students may need to complete additional classes to reach the 60 credit total.

Program Advisors

Pathway Advisors are the Academic Advisors for the Associate of Arts degree and are located in the Advising Center, Room 1340, Main Floor. For assistance or additional information, please call our Advising Center at 651.846.1739 or email: advising@saintpaul.edu

Additional Requirements

- At least 60 earned college-level credits (40 MnTC credits and 20 additional MnTC, pre-major or elective credits)
- A grade of "C" or better in ENGL 1711
- Associate of Arts (AA) cumulative GPA of 2.0
- Minnesota Transfer Curriculum (MnTC) cumulative GPA of 2.0
- Meet Saint Paul College residency requirement: 20 credits. This requirement may be reduced to 12 credits with transfer of at least 12 college-level credits from another Minnesota State College and University or the University of Minnesota.

Program Start Dates

Fall, Spring, Summer

Course Sequence

Students are allowed to take the courses in any sequence. However, all course prerequisites need to be followed. For specific suggestions, please speak with a Pathway Advisor or one of the program faculty. Students should consult with the Program Advisor each semester.

Not all courses are offered each semester; a selection of courses is offered summer term.

Minimum Program Entry Requirements

Students entering this program must meet the following minimum program entry requirements:

Reading: Score of 78+ or grade of "C" or better in READ 0722

Writing: Score of 78+ or grade of "C" or better in ENGL 0922

Arithmetic: Score of 20+; Visit the Advising Center to determine if the transfer programs require college-level mathematics.

Assessment Results and Prerequisites: Students admitted to Saint Paul College programs may need to complete additional courses based on assessment results and course prerequisite requirements. Certain MATH, READ, and ENGL courses have additional prerequisites.

99AACRIM

Associate of Arts DEGREE

Emphasis in Social Science/Public Affairs

Program Overview

The Associate of Arts Degree - Emphasis in Social Science/Public Affairs provides students with the opportunity to learn both the political science-based interpretation of public policy as well as the integration of other disciplines and fields that directly contribute to the management of public interest.

Career Opportunities

Students who successfully complete the Associate of Arts Degree – Emphasis in Social Science/Public Affairs will be prepared to transfer to a baccalaureate program in Social Science or Political Science. With a degree in political science you can work in a number of fields within the Government and Public Administration system such as compliance officers, operations managers, political scientists, and public relations specialists.

Program Outcomes

1. Apply knowledge of the important concepts and principles of the natural science, mathematics, history, social and behavioral sciences, arts, and humanities.
2. Develop skills necessary for life roles, including skills in thinking, communication and methods of inquiry and applications of knowledge.
3. Critically examine and develop an appreciation for diverse people, cultures, and life roles.
4. Develop oral and written communication skills to communicate with a wide range of diverse populations.
5. Demonstrate an understanding of the fields of social science and public affairs and apply political theory to contemporary problems and issues.

Transfer Opportunities

Saint Paul College has a transfer articulation agreement between the following program and post-secondary institution for the baccalaureate degree program listed below.

For more information please go to saintpaul.edu/Transfer.

Associate of Arts Degree - Emphasis in Social Science/Public Affairs

BA	Social Science - Generalist Metropolitan State University
BA	Social Science - Political Science Metropolitan State University

Program Faculty

James Andresen james.andresen@saintpaul.edu

Program Requirements

Check off when completed

Emphasis Requirements	Cr
<input type="checkbox"/> PHIL 1720 Ethics	3
<input type="checkbox"/> POLS 1720 Intro to American Government	3
<input type="checkbox"/> POLS 1750 Intro to Political Science	3
<input type="checkbox"/> POLS 1760 Intro to Political Philosophy	3
<input type="checkbox"/> Social Science Electives	8
Any MnTC Goal 5 course may be counted; however, the following are recommended: ECON 1720 Macroeconomics – 3 cr ECON 1730 Microeconomics – 3 cr POLS 1790 Special Topics in Political Science – 1-6 cr PSYC/SOCI 2720 Social Psychology – 4 cr SOCI 1720 Social Problems – 3 cr	
Emphasis Total	20

MnTC Requirements	Cr
Refer to the Minnesota Transfer Curriculum Course List for each Goal Area	
<input type="checkbox"/> Goal 1: Communication	9
ENGL 1711 Composition 1 – 4 cr ENGL 1712 Composition 2 – 2 cr COMM 17XX – 3 cr	
<input type="checkbox"/> Goal 2: Critical Thinking	9
<i>Fulfilled when 10 goal areas (40 credits) are completed.</i>	
<input type="checkbox"/> Goal 3 Natural Science	7
<i>Two courses from two different disciplines, one of which must be a lab course.</i>	
<input type="checkbox"/> Goal 4 : Mathematical/Logical Reasoning	3
<i>One course numbered between 1700-1799 or 2700-2799.</i>	
<input type="checkbox"/> Goal 5: History, Social Science, and Behavioral Sciences	9
<i>Three courses from two different disciplines.</i> Emphasis courses POLS 1720 – 3 cr, POLS 1750 – 3 cr will count toward Goal 5. One additional non-POLS course is required.	
<input type="checkbox"/> Goal 6: Humanities & Fine Arts	9
<i>Three courses from two different disciplines.</i> Emphasis course PHIL1720 – 3 cr will count toward Goal 6. Two additional courses are required.	
<input type="checkbox"/> Goal Areas 7-10 of the MnTC	40
<i>Select courses to meet all 10 Goal Areas</i>	
MnTC Requirements Total	40

Total Program Credits 60

If courses are counted in both the Emphasis Requirements and the MnTC Requirements students may need to complete additional classes to reach the 60 credit total.

Program Advisor

Pathway Advisors are the Academic Advisors for the Associate of Arts degree and are located in the Advising Center, Room 1340, Main Floor. For assistance or additional information, please call our Advising Center at 651.846.1739 or email: advising@saintpaul.edu

Additional Requirements

- At least 60 earned college-level credits (40 MnTC credits and 20 additional MnTC, pre-major or elective credits)
- A grade of "C" or better in ENGL1711
- Associate of Arts (AA) cumulative GPA of 2.0
- Minnesota Transfer Curriculum (MnTC) cumulative GPA of 2.0
- Meet Saint Paul College residency requirement: 20 credits. This requirement may be reduced to 12 credits with transfer of at least 12 college-level credits from another Minnesota State College and University or the University of Minnesota.

Program Start Dates

Fall, Spring, Summer

Course Sequence

Students are allowed to take the courses in any order. However, all course prerequisites need to be followed. For specific suggestions, please speak with a Pathway Advisor or the program faculty. Students should consult with the Program Advisor each semester.

Not all courses are offered each semester; a selection of courses is offered summer term.

Minimum Program Entry Requirements

Students entering this program must meet the following minimum program entry requirements:

Reading: Score of 78+ or grade of "C" or better in READ 0722

Writing: Score of 78+ on Reading Comprehension or grade of "C" or better in ENGL 0922

Arithmetic: Score of 20+

Assessment Results and Prerequisites: Students admitted into Saint Paul College programs may need to complete additional courses based on assessment results and course prerequisite requirements. Certain MATH, READ, and ENGL courses have additional prerequisites.

99AASSPA

*Information is subject to change.
This Program Requirements Guide is not a contract.*

Associate of Fine Arts DEGREE

Music

Program Overview

The Associate of Fine Arts in Music provides students with the educational foundation needed to transfer to a four-year music program. The program will offer music theory and music history as well as develop performance skills.

Career Opportunities

Students who successfully complete the Associate of Fine Arts in Music Degree will be prepared to transfer to a baccalaureate program in Music. With a degree in music you can pursue careers as college or high school music teachers, music directors and composers, or musicians and singers.

Program Outcomes

1. Apply knowledge of the important concepts and principles of the natural science, mathematics, history, social and behavioral sciences, arts, and humanities.
2. Develop skills necessary for life roles, including skills in thinking, communication, and methods of inquiry and applications of knowledge.
3. Critically examine and develop an appreciation for diverse people, cultures, and life roles.
4. Develop oral and written communication skills to communicate with a wide range of diverse populations.
5. Demonstrate an understanding of the field of music and apply elements of musical theory, history, and performance.

Transfer Opportunities

Saint Paul College has a transfer articulation agreement between the following program and post-secondary institution for the baccalaureate degree program listed below.

For more information please go to saintpaul.edu/Transfer.

Associate of Fine Arts - Music

BS Music Education
Southwest Minnesota State University

Program Advisors

Pathway Advisors are the Academic Advisors for the Associate of Arts degree and are located in the Advising Center, Room 1340, Main Floor. For assistance or additional information, please call our Advising Center at 651.846.1739 or email: advising@saintpaul.edu

*Information is subject to change.
This Program Requirements Guide is not a contract.*

Program Faculty

Linda Chacholiades
linda.chacholiades@saintpaul.edu
Michael Krajewski
michael.krajewski@saintpaul.edu
Michael Olsen
michael.olsen@saintpaul.edu

Program Requirements

All MUSC classes must be completed with a grade of "C" or better.

Check off when completed

Course	Cr
<input type="checkbox"/> MUSC 1701 Music Theory 1	2
<input type="checkbox"/> MUSC 1702 Aural Skills 1	1
<input type="checkbox"/> MUSC 1703 Music Theory 2	2
<input type="checkbox"/> MUSC 1704 Aural Skills 2	1
<input type="checkbox"/> MUSC 1735 Class Piano 1	2
<input type="checkbox"/> MUSC 1736 Class Piano 2	2
<input type="checkbox"/> MUSC 1800 Music Production 1	3
<input type="checkbox"/> MUSC 2700 Music Theory 3	2
<input type="checkbox"/> MUSC 2705 Aural Skills 3	1
<input type="checkbox"/> MUSC 2710 Music Theory 4	2
<input type="checkbox"/> MUSC 2715 Aural Skills 4	1
<input type="checkbox"/> MUSC 2720 Music History 1: Medieval to Baroque	3
<input type="checkbox"/> MUSC 2721 Music History 2: Classical to Modern	3
<input type="checkbox"/> Select 8 credits of lessons in a primary instrument	8
MUSC 1030 Applied String – 2cr	
MUSC 1310 Applied Voice – 2cr	
MUSC 1320 Applied Piano – 2cr	
<input type="checkbox"/> Select 4 credits of ensemble music	4
MUSC 1730 Concert Choir – 2cr	
MUSC 2711 Chamber Singers – 2cr	
MUSC 2713 Guitar Ensemble – 2cr	
MUSC 2714 String Ensemble – 2cr	
Subtotal	37

General Education/MnTC Requirements

General Education/MnTC Requirements	Cr
Refer to the Minnesota Transfer Curriculum Course List for each Goal Area	
<input type="checkbox"/> Goal 1: Communication	7
ENGL 1711 Composition 1 – 4 cr	
COMM 1710 Fundamentals of Public Speaking – 3 cr	
<input type="checkbox"/> Goal 3 or Goal 4	3
Goal 3: Natural Sciences	
OR Goal 4: Mathematical/Logical Reasoning	
<input type="checkbox"/> Goal 5: History, Social Science, and Behavioral Sciences	3
<input type="checkbox"/> Goal 6: Humanities & Fine Arts (recommended)	3
ARTS, ENGL, HUMA, PHIL, SPAN or THTR	

Goal 1-10 of the MnTC 15
Students must select courses from at least six (6) MnTC goal areas.*
General Education Requirements 31

Total Program Credits 68

*Suggested courses include:
MUSC 1745 History of Rock & Roll
MUSC 1750 Jazz History
MUSC 1760 American Music
MUSC 1765 Music of Latin America & the Caribbean
MUSC 1770 Music in World Cultures
MUSC 2800 Music Production 2

Program Start Dates

Fall, Spring, Summer

Course Sequence

Students should consult with the Program Advisor each semester. Not all courses are offered each semester; a selection of courses is offered summer term.

See back of this guide for Course Sequence

Minimum Program Entry Requirements

Students entering this program must meet the following minimum program entry requirements:

Reading: Score of 78+ or grade of "C" or better in READ 0722

Writing: Score of 78+ on Reading Comprehension or grade of "C" or better in ENGL 0922

Arithmetic: Score of 20+

Assessment Results and Prerequisites: Students admitted into Saint Paul College programs may need to complete additional courses based on assessment results and course prerequisite requirements. Certain MATH, READ, and ENGL courses have additional prerequisites.

99FA

Associate of Fine Arts DEGREE *(continued)*

Music

Course Sequence

Students should consult with the Program Advisor each semester. Not all courses are offered each semester; a selection of courses is offered summer term.

First Semester

MUSC 1701 Music Theory 1 (fall only)	2
MUSC 1702 Aural Skills 1 (fall only)	1
MUSC 1735 Class Piano 1	2
Primary Instrument Lessons	2
Ensemble Music	2
ENGL 1711 Composition 1	4
COMM 1710 Fund of Public Speaking	3
Total Semester Credits	16

Second Semester

MUSC 1703 Music Theory 2 (spring only)	2
MUSC 1704 Aural Skills 2 (spring only)	1
MUSC 1736 Class Piano 2 (spring only)	2
Primary Instrument Lessons	2
Ensemble Music	2
Goal 3 or 4	3
Goal 5	3
Goal 6	3
Total Semester Credits	18

Third Semester

MUSC 1800 Music Production 1	3
MUSC 2700 Music Theory 3 (fall only)	2
MUSC 2705 Aural Skills 3 (fall only)	1
MUSC 2720 Music History 1 (fall only)	3
Primary Instrument Lessons	2
MnTC Electives	6
Total Semester Credits	17

Fourth Semester

MUSC 2710 Music Theory 4 (spring only)	2
MUSC 2715 Aural Skills 4 (spring only)	1
MUSC 2721 Music History 2 (spring only)	3
Primary Instrument Lessons	2
MnTC Electives	9
Total Semester Credits	17

Total Program Credits 68

American Sign Language Studies CERTIFICATE

Program Overview

The American Sign Language Studies Certificate Program provides students with the knowledge and skills of American Sign Language (ASL), focusing on the uniqueness of ASL as a language, Deaf Culture and Deaf History. The program encourages students to become involved in the social and cultural activities of the Deaf Community. The curriculum provides a solid and basic foundation for entry into a career in a deafness-related field and prepares students for continued educational studies in a variety of disciplines. It is a pathway to entering the Sign Language Interpreter/Transliterators Program at Saint Paul College or similar programs at other institutions. Individuals who intend to, or currently work with Deaf and/or Hard-of-Hearing individuals in fields such as education, human/ social services, community service agencies, and vocational rehabilitation benefit from the opportunity to learn and develop stronger skills in American Sign Language.

It is necessary for students in the American Sign Language Studies Program to be able to process visual information.

Career Opportunities

Completion of the American Sign Language Studies Certificate:

- Enhances the ability to work and communicate more effectively with Deaf and Hard-of-Hearing people in academic, agency, and business settings.
- Provides opportunities to enhance ASL fluency and acquire Deaf Culture knowledge which is applicable to a variety of educational disciplines.
- Prepares students to meet the ASL prerequisites for the Sign Language Interpreter/Transliterators Program.
- Enhances American Sign Language fluency for potential or current teachers of Deaf and Hard-of-Hearing students.

Program Outcomes

1. Graduates will be prepared to meet the ASL prerequisites for the Sign Language Interpreter/Transliterators Program.
2. Graduates will develop ASL skills and Deaf Culture awareness to more effectively communicate with Deaf and Hard-of-Hearing people in a variety of settings.
3. Graduates will meet world language requirements at the high school and college/ university level.
4. Graduates will be prepared to take an American Sign Language Proficiency Interview and to meet K-12 Skill Levels.
5. Graduates will meet entrance requirements for undergraduate or graduate programs in ASL Studies, Linguistics, and Deaf Education.

Program Faculty

Rania Johnson rania.johnson@saintpaul.edu

Part-time/Full-time Options

Part-time and full-time options are available.

Sign Language Interpreter/Transliterators Program

Students planning to enroll in the Sign Language Interpreter/Transliterators Program after completing this certificate program must meet the program standards and complete the [Application to Sign Language Interpreter/Transliterators AAS Degree Major](#) form to apply for admission.

In the Sign Language Interpreter/Transliterators Program, it is necessary for students to be able to process auditory and visual information.

College Credit by Exam/Test-out

If a student has successfully completed a Saint Paul College Credit by Exam/Test-Out of ASLS 1411 American Sign Language 1 and/or ASLS 1412 American Sign Language 2, then ASLS 1415 American Sign Language 5 is strongly recommended. Students who have not had recent ASL courses (within the past 24 months) at date of application will need to refresh their skills by repeating their last ASL course.

Credits by Exam/Test-Outs are not transferable from other educational institutions.

Program Requirements

Check off when completed

Course	Cr
<input type="checkbox"/> Goal 1: COMM 17XX	3
<input type="checkbox"/> ASLS 1411 American Sign Language 1	3
<input type="checkbox"/> ASLS 1412 American Sign Language 2	3
<input type="checkbox"/> ASLS 1413 American Sign Language 3	3
<input type="checkbox"/> ASLS 1414 American Sign Language 4	3
<input type="checkbox"/> ASLS 1420 ASL Linguistics	4
<input type="checkbox"/> ASLS 1430 Classifiers	3
<input type="checkbox"/> ASLS 1435 Deaf Studies/Culture	3
<input type="checkbox"/> ASLS 1443 ASL Fingerspelling and Numbers	3
Subtotal	28
Select 2 credits from following Technical Electives	
<input type="checkbox"/> ASLS 1415 American Sign Language 5	3
<input type="checkbox"/> ASLS 1446 ASL Non-Manual Markers	2
<input type="checkbox"/> ASLS 1450 American Sign Language Semantics	3
<input type="checkbox"/> ASLS 1497 Special Topics in ASL	1-5

Total Program Credits 30

Optional Course

ASLS 1469 Deaf Heritage of Minnesota 2
 Course is not offered annually.

See back of this guide for Course Sequence and Guidelines for Placement

Minimum Program Entry Requirements

Students entering this program must meet the following minimum program entry requirements:

It is necessary for students in the American Sign Language Studies Program to be able to process visual information.

Reading: Score of 78+ or grade of "C" or better in READ 0722.

Arithmetic: Score of 20+

If you intend to enroll in the Sign Language Interpreter/Transliterators program, be aware there is a program prerequisite in arithmetic and writing.

Assessment Results and Prerequisites: Students admitted into Saint Paul College programs may need to complete additional courses based on assessment results and course prerequisite requirements. Certain MATH, READ, and ENGL courses have additional prerequisites.

125C (7060)

*Information is subject to change.
 This Program Requirements Guide is not a contract.*

American Sign Language Studies CERTIFICATE *(continued)*

Program Start Dates

Fall, Spring, Summer

Course Sequence

The following sequence is recommended; however, it is not required. Not all courses are offered each semester; a selection of courses is offered summer term. Some courses are available day and evening; some courses are available days only.

First Semester

Goal 1: COMM 17XX	3
ASLS 1411 American Sign Language 1	3
ASLS 1412 American Sign Language 2	3
Total Semester Credits	9

Second Semester

ASLS 1413 American Sign Language 3	3
ASLS 1414 American Sign Language 4	3
Total Semester Credits	6

Third Semester

ASLS 1420 ASL Linguistics	4
*ASLS 1443 ASL Fingerspelling and Numbers	3
Total Semester Credits	7

Fourth Semester

ASLS 1430 Classifiers	3
*Technical Elective	2
Total Semester Credits	5

ASLS 1435 Deaf Studies/Culture	3
Can be taken anytime during the program.	

Total Program Credits	30
------------------------------	-----------

* Technical electives can be taken in Fall Semester and ASLS 1443 Fingerspelling and Numbers can be taken during Spring Semester.

Guidelines for Placement in ASL

Courses at Saint Paul College

Students with no or little background in ASL

If you have little or no background in ASL you should register for ASLS 1411 American Sign Language 1, which is the first course in our ASL language sequence.

Students with college-level study of ASL

If you have taken ASL courses at another higher education institution, you should have your transcripts evaluated in order to determine appropriate placement.

Students with high school study of ASL

If you have studied ASL for one year or less in high school, enroll in ASLS 1411 American Sign Language 1.

If you have studied ASL for two or more years in high school and can answer "yes" to three or more of the following questions, then you may take a test out on SPC campus.

1. Did you study ASL during your junior AND senior years of high school?
2. Did you graduate from high school during the past two years?
3. Did your teacher use ASL without voice in class?
4. Is ASL your primary language?

For-credit course placement Test Out:

Students may take a test out at their own expense to determine whether they have the linguistic proficiency necessary to enroll in our second, third, or fourth semester ASL courses. Students passing this test out will receive college-level credit, but will not receive a letter grade. For more information about this test, see the American Sign Language Studies page on the college website.

Non-credit course placement

Sign Language Proficiency Interview (SLPI):

This exam has a fee and a documentation of SLPI rating will be required for non-credit placement. Students scoring advanced/advanced plus on the SLPI evaluation will be allowed to register for ASLS 1414 (ASL 4).

Students scoring intermediate plus on the SLPI evaluation will be allowed to register for ASLS 1413 (ASL 3).

For more information on how to take SLPI go to <http://www.msad.state.mn.us/Staff/SLPI%20Registration%20Form%202014-2015.pdf>. This is not associated with Saint Paul College.

These guidelines are subject to change. Please, make sure you are following the most current version.

English for Academic Purposes (EAP)

Overview

The English for Academic Purposes (EAP) Program is designed to help English learners enter and succeed in the community and technical college system as well as in the transfer curriculum.

EAPP courses focus on speaking and listening, reading and vocabulary, writing and grammar, and pronunciation.

Depending on their intended major, students completing the EAPP courses may begin one of the career and technical programs or enroll in general education courses.

Students interested in enrolling in the EAPP courses must take the ESL ACCUPLACER test. This test assesses reading, listening and grammar ability.

Outcomes

1. Apply the rules of English grammar and pronunciation to college communication.
2. Read college level texts.
3. Comprehend college level lectures.
4. Function in an academic environment in the United States.

Application Process

Step 1:

Apply for Admission

Fill out and submit the online Saint Paul College application at saintpaul.edu/apply or stop by One Stop Room 1300 where computers are available for submitting an application online to be admitted to the College.

Step 2:

Take the ESL ACCUPLACER

The ESL ACCUPLACER is a computerized test that covers reading, writing and listening. The test takes about 2 hours to finish, but students may take as much time as needed. An appointment is not needed to take this test. Students must check in at the One Stop (Room 1300) and will then go to the location where the test is administered. When they finish with all parts of the test, students must take their test scores to One Stop.

Step 3:

Attend Orientation / Registration Session

Students receive an email from Saint Paul College about which Orientation Session to attend. At Orientation, students learn more about the College, register for classes and also meet with EAP Program instructors.

Program Faculty

Barbara Kennedy

barbara.kennedy@saintpaul.edu

Amy Tarrell-Florey amy.tarrell@saintpaul.edu

Inna Wolfson inna.wolfson@saintpaul.edu

Part-time/Full-time Options

Students may attend either part-time or full-time.

Course Requirements

Check off when completed

Course	Cr
<input type="checkbox"/> EAPP 0760 High Intermediate Reading and Vocabulary	5
<input type="checkbox"/> EAPP 0770 High Intermediate Writing and Grammar	5
<input type="checkbox"/> EAPP 0780 High Intermediate Speaking and Listening	5
<input type="checkbox"/> EAPP 0860 Advanced Reading and Vocabulary	5
<input type="checkbox"/> EAPP 0870 Advanced Writing and Grammar	5
<input type="checkbox"/> EAPP 0880 Advanced Speaking and Listening	5
Total Course Credits	30

Electives	Cr
<input type="checkbox"/> EAPP 1400 English Pronunciation for Academic and Professional Purposes	2
<input type="checkbox"/> EAPP 0900 Academic Reading and Writing	5
<input type="checkbox"/> EAPP 1490 Special Topics in English for Speakers of Other Languages	1-6
Total Course Credits	30

Program Start Dates

Fall, Spring

Course Sequence

The following sequence is recommended for a full-time student, however, it is not required.

First Semester

EAPP 0760 High Intermediate Reading and Vocabulary	5
EAPP 0770 High Intermediate Writing and Grammar	5
EAPP 0780 High Intermediate Speaking and Listening	5
Total Semester Credits	15

Second Semester

EAPP 0860 Advanced Reading and Vocabulary	5
EAPP 0870 Advanced Writing and Grammar	5
EAPP 0880 Advanced Speaking and Listening	5
Total Semester Credits	15

Third Semester

Third semester options depend on a student's major and language ability. Some students may enroll in an English- EAPP Learning Community (LCOM), others may take READ 0722: Reading 2 and ENGL 0922: Fundamentals of Writing 2, and some may begin a career or technical program. Students will work with EAP Program advisors to choose the courses that best fit their needs and major requirements.

Total Course Credits 30

Minimum Program Entry Requirements

ESL Reading Skills: Score of 65+

ESL Listening: Score of 68+

Assessment Results and Prerequisites:

Students admitted into Saint Paul College programs may need to complete additional courses based on assessment results and course prerequisite requirements. Certain MATH, READ, and ENGL courses have additional prerequisites.

8095

*Information is subject to change.
This Program Requirements Guide is not a contract.*

Associate of Arts DEGREE

Communication Studies Transfer Pathway

Program Overview

The Communication Studies Transfer Pathway provides students with the opportunity to learn how to write strong messages and speak persuasively. Students will also build skills in networking, team building, and conflict management.

Career Opportunities

Students who successfully complete the Communication Studies Transfer Pathway will be prepared to transfer to a baccalaureate program in Professional Communications. With a degree in Communications you can work in a number of fields within the Arts, Audio-Video Technology and Communications sectors such as Communications Director, Customer Relations, Media Relations, Journalism and Sales.

Program Outcomes

1. Apply knowledge of the important concepts and principles of the natural science, mathematics history, social and behavioral sciences, arts, and humanities.
2. Develop skills necessary for life roles, including skills in thinking, communication, and methods of inquiry and applications of knowledge.
3. Critically examine and develop an appreciation for diverse people, cultures, and life roles.
4. Develop oral and written communication skills to communicate with a wide range of diverse populations.
5. Demonstrate an understanding of communication skills in both spoken and written form.

Transfer Opportunities

Saint Paul College has a transfer articulation agreement between the following program and post-secondary institution for the baccalaureate degree program listed below.

For more information please go to saintpaul.edu/Transfer.

Communication Transfer Pathway AA

BA	Professional Communication Metropolitan State University
BS	Communication Studies Minnesota State, Mankato
BA	Communication Studies Minnesota State, Moorhead
BA	Communication Studies Southwest State University
BA	Communication Studies St. Cloud State University
BA	Communication Studies Winona State University

Program Faculty

Anna Ignatjeva	anna.ignatjeva@saintpaul.edu
Dan Paulnock	daniel.paulnock@saintpaul.edu
Shelby Reigstad	shelby.reigstad@saintpaul.edu

Program Requirements

Check off when completed

Emphasis Requirements	Cr
<input type="checkbox"/> COMM 1710 Fundamentals of Public Speaking	3
<input type="checkbox"/> COMM 1720 Interpersonal Communication	3
<input type="checkbox"/> COMM 1730 Intercultural Communication	3
<input type="checkbox"/> COMM 1750 Small Group Communication	3
<input type="checkbox"/> COMM 1780 Gender Communication	3
<input type="checkbox"/> Communication Studies Electives	5
Any MnTC course may be counted; however, the following are recommended:	
COMM 1740 Mass Media & Communication- 3 cr	
COMM 1770 Family Communication- 3 cr	
Emphasis Total	20

MnTC Requirements

Refer to the Minnesota Transfer Curriculum Course List for each Goal Area

<input type="checkbox"/> Goal 1: Communication	9
ENGL 1711 Composition 1 – 4 cr	
ENGL 1712 Composition 2 – 2 cr	
COMM 17XX- 3 cr Requirement met with emphasis COMM courses.	
<input type="checkbox"/> Goal 2: Critical Thinking	
Fulfilled when 10 goal areas (40 credits) are completed.	
<input type="checkbox"/> Goal 3 Natural Science	7
Two courses from two different disciplines, one of which must be a lab course.	
<input type="checkbox"/> Goal 4: Mathematical/Logical Reasoning	3
One course numbered between 1700-1799 or 2700-2799.	
<input type="checkbox"/> Goal 5: History, Social Sciences and Behavioral Sciences	9
Three courses from two different disciplines.	
<input type="checkbox"/> Goal 6: Humanities & Fine Arts.	9
Three courses from two different disciplines.	
<input type="checkbox"/> Goal Areas 7-10	
Select courses to meet all 10 Goal Areas	
MnTC Requirements Total	40

Total Program Credits60

If courses are counted in both the Emphasis Requirements and the MnTC Requirements students may need to complete additional classes to reach the 60 credit total.

*Information is subject to change.
This Program Requirements Guide is not a contract.*

Program Advisors

Pathway Advisors are the Academic Advisors for the Associate of Arts degree and are located in the Advising Center, Room 1340, Main Floor. For assistance or additional information, please call our Advising Center at 651.846.1739 or email: advising@saintpaul.edu

Additional Requirements

- At least 60 earned college-level credits (40 MnTC credits and 20 additional MnTC, pre-major or elective credits)
- A grade of "C" or better in ENGL1711
- Associate of Arts (AA) cumulative GPA of 2.0
- Minnesota Transfer Curriculum (MnTC) cumulative GPA of 2.0
- Meet Saint Paul College residency requirement: 20 credits. This requirement may be reduced to 12 credits with transfer of at least 12 college-level credits from another Minnesota State College and University or the University of Minnesota.

Program Start Dates

Fall, Spring, Summer

Course Sequence

Students are allowed to take the courses in any sequence. However, all course prerequisites need to be followed. For specific suggestions, please speak with a Pathway Advisor or the program faculty. Students should consult with the Program Advisor each semester.

Not all courses are offered each semester, a selection of courses is offered summer term.

Minimum Program Entry Requirements

Students entering this program must meet the following minimum program entry requirements:

Reading: Score of 78+ or grade of "C" or better in READ 0722

Writing: Score of 78+ on Reading Comprehension or grade of "C" or better in ENGL 0922

Arithmetic: Score of 20+

Assessment Results and Prerequisites: Students admitted into Saint Paul College programs may need to complete additional courses based on assessment results and course prerequisite requirements. Certain MATH, READ, and ENGL courses have additional prerequisites.

TPCO

Associate of Arts DEGREE

History Transfer Pathway

Program Overview

The History Transfer Pathway provides students with the opportunity to study the narrative of past events as they relate to the human race. They use this knowledge to discuss, write, and educate others regarding the interpretation of the past.

Career Opportunities

Students who successfully complete the History Transfer Pathway will be prepared to transfer to a baccalaureate program in History. With a degree in History you can work in a number of fields within the government and education systems such as special collections librarians, archivists, museum work, and faculty at secondary and post-secondary institutions. A History degree is also useful preparation for careers in policy studies or the practice of law.

Program Outcomes

1. Students will demonstrate a broad understanding of U.S. history and at least one period of world history.
2. Students will make use of historical thinking.
3. Students will analyze historical sources, distinguishing primary from secondary sources.
4. Students will communicate effectively using historical evidence and methods.
5. Students will analyze and understand the diversity of peoples within their distinctive historical contexts.

Transfer Opportunities

Saint Paul College has a transfer articulation agreement between the following program and post-secondary institution for the baccalaureate degree program listed below.

For more information please go to saintpaul.edu/Transfer.

History Transfer Pathway AA

BA	History	Metropolitan State University
BA	History	Southwest State University
BA	History	Winona State University
BA	History	Bemidji State University
BA	History	Minnesota State University, Mankato
BA	History	Minnesota State University, Moorhead
BA	History	Saint Cloud State University

Program Faculty

Kurt Kortenhof kurt.kortenhof@saintpaul.edu
 Ayesha Shariff ayasha.shariff@saintpaul.edu

Program Requirements

Check off when completed

Pathway Requirements	Cr
<input type="checkbox"/> HIST 1745 U.S. History To 1877	4
<input type="checkbox"/> HIST 1746 U.S. History Since 1877	4
AND one of the following:	
<input type="checkbox"/> HIST 1760 History of World Civ. to 1500	3
<input type="checkbox"/> HIST 1761 History of World Civ. since 1500	3
Subtotal	11
<input type="checkbox"/> History Electives	9
Any MnTC Goal 5 course may be counted; however, the following are recommended:	
HIST 1730 Contemporary World History – 3 cr	
HIST 1750 Minnesota History – 3 cr	
HIST 1770 History of Women in the U.S. – 3 cr	
HIST 1773 African American History – 3 cr	
HIST 2740 Immigration and Ethnic History of the U.S. – 3cr	
HIST 2780 Special Topics in History (1-6)	
HIST 2790 Historical Methods – 2 cr	
Pathway Total	20

MnTC Requirements

MnTC Requirements	Cr
Refer to the Minnesota Transfer Curriculum Course List for each Goal Area	
<input type="checkbox"/> Goal 1: Communication	9
ENGL 1711 Composition 1 – 4 cr	
ENGL 1712 Composition 2 – 2 cr	
COMM 17XX – 3 cr	
<input type="checkbox"/> Goal 2: Critical Thinking	
<i>Fulfilled when 10 goal areas (40 credits) are completed.</i>	
<input type="checkbox"/> Goal 3 Natural Science	7
<i>Two courses from two different disciplines, one of which must be a lab course.</i>	
<input type="checkbox"/> Goal 4: Mathematical/Logical Reasoning	3
<i>One course numbered between 1700-1799 or 2700-2799.</i>	
<input type="checkbox"/> Goal 5: History, Social Science and Behavioral Sciences	9
<i>Three courses from two different disciplines.</i>	
Pathway courses HIST 1745 and HIST 1746 will count toward Goal 5.	
One additional non-HIST course is required.	
<input type="checkbox"/> Goal 6: Humanities & Fine Arts.	9
<i>Three courses from two different disciplines.</i>	
<input type="checkbox"/> Goal Areas 7-10	
<i>Select courses to meet all 10 Goal Areas</i>	
MnTC Requirements Total	40

Total Program Credits 60

*Information is subject to change.
 This Program Requirements Guide is not a contract.*

If courses are counted in both the Pathway Requirements and the MnTC Requirements students may need to complete additional classes to reach the 60 credit total.

Program Advisor

Pathway Advisors are the Academic Advisors for the Associate of Arts degree and are located in the Advising Center, Room 1340, Main Floor. For assistance or additional information, please call our Advising Center at 651.846.1739 or email: advising@saintpaul.edu

Additional Requirements

- At least 60 earned college-level credits (40 MnTC credits and 20 additional MnTC, pre-major or elective credits)
- A grade of "C" or better in ENGL 1711
- Associate of Arts (AA) cumulative GPA of 2.0
- Minnesota Transfer Curriculum (MnTC) cumulative GPA of 2.0
- Meet Saint Paul College residency requirement: 20 credits. This requirement may be reduced to 12 credits with transfer of at least 12 college-level credits from another Minnesota State College and University or the University of Minnesota.

Program Start Dates

Fall, Spring, Summer

Course Sequence

Students are allowed to take the courses in any order. However, all course prerequisites need to be followed. For specific suggestions, please speak with a Pathway Advisor or the program faculty. Students should consult with the Program Advisor each semester. Not all courses are offered each semester; a selection of courses is offered summer term.

Minimum Program Entry Requirements

Students entering this program must meet the following minimum program entry requirements:

Reading: Score of 78+ or grade of "C" or better in READ 0722

Writing: Score of 78+ on Reading Comprehension or grade of "C" or better in ENGL 0922

Arithmetic: Score of 20+

Assessment Results and Prerequisites: Students admitted into Saint Paul College programs may need to complete additional courses based on assessment results and course prerequisite requirements. Certain MATH, READ, and ENGL courses have additional prerequisites.

TPHI

Liberal Arts Courses

Course delivery methods change on a semester basis. Please check the current course schedule for the most up-to-date information at saintpaul.edu/CourseSchedule.

Communications

English Overview

The English and Communications faculty are dedicated to helping students apply the knowledge and skills gained through the study of writing and literature to successfully communicate in work and life roles. Two levels of developmental writing courses are available. The department offers a wide selection of transferable general education courses including Composition 1 and 2 and literature courses including the Survey of American Literature, The English Novel, Native American and African American Literature, an Introduction to Poetry and others. Students planning to transfer to a four-year degree generally enroll in Composition courses and one or two related electives as they fulfill requirements for the Associate of Arts, Associate of Science and Associate of Applied Science degrees.

Course	Cr
ENGL 0921* Fundamentals of Writing 1	4
ENGL 0922* Fundamentals of Writing 2	4
ENGL 1711 Composition 1	4
ENGL 1712 Composition 2	2
ENGL 1720 Introduction to Creative Writing	3
ENGL 1725 Introduction to Fiction Writing	3
ENGL 1730 Introduction to Technical Writing	3
ENGL 1735 Introduction to Non-Fiction-Memoir Writing	3
ENGL 1770 Introduction to Poetry Writing	3
ENGL 1780 Recently-Arrived Contemporary Immigrant Literature	3
ENGL 1790 Contemporary Writers of Color	3
ENGL 2721 Survey of American Literature 1	3
ENGL 2722 Survey of American Literature 2	3
ENGL 2725 Survey of British Literature	3
ENGL 2730 Contemporary American Novel	3
ENGL 2732 Exploring the Short Story	3
ENGL 2750 African American Literature	3
ENGL 2755 LGBTQ Writers	3
ENGL 2760 The English Novel	3
ENGL 2770 Introduction to Poetry	3
ENGL 2775 Introduction to Speculative Fiction and Fantasy Literature	3
ENGL 2776 Women Writers	3
ENGL 2778 Urban Literature – Lost in the City	3
ENGL 2790 Special Topics in English	1-6

* Does not meet Minnesota Transfer Curriculum (MnTC) Distribution Requirements

Department Faculty

Justin Bonnett	651.846.1704	justin.bonnett@saintpaul.edu
Brandon Chitwood	651.403.4440	brandon.chitwood@saintpaul.edu
Mary Crispin	651.846.1670	mary.crispin@saintpaul.edu
Kasandra Duthie	651.403.4088	kasandra.duthie@saintpaul.edu
Natasha Fleischman	651.403.4199	natasha.fleischman@saintpaul.edu
Kelly Hulander	651.403.4033	kelly.hulander@saintpaul.edu
Carla-Elaine Johnson	651.846.1524	carla-elaine.johnson@saintpaul.edu
Michael Leggs	651.846.1705	michael.leggs@saintpaul.edu
William Lund	651.846.1568	william.lund@saintpaul.edu
John Schlueter	651.403.4483	john.schlueter@saintpaul.edu
Susan Taylor	651.403.4016	susan.taylor@saintpaul.edu
Samantha Ten Eyck	651.846.1574	samantha.teneyck@saintpaul.edu
Jody Wheeler	651.846.1359	jody.wheeler@saintpaul.edu

Reading Overview

The Reading faculty are dedicated to helping students become proficient and successful readers so they may apply this knowledge to meet the demands of their content-area and program specific reading assignments and their future careers. College reading involves a variety of skills and strategies used together to gain meaning from academic or technical text; it requires critical thinking, draws on background knowledge of a variety of topics, and makes use of a large vocabulary.

Course	Cr
READ 0721* Reading 1	3
READ 0722* Reading 2	3
READ 0724* Fast Track Reading	5
READ 0725* Vocabulary Development	1
READ 1490* Special Topics in Reading	1-6

Department Faculty

Natasha Fleischman	651.403.4199	natasha.fleischman@saintpaul.edu
Patti Gage	651.846.1307	patti.gage@saintpaul.edu
Celeste Mazur	651.846.1373	celeste.mazur@saintpaul.edu
Jennie Olsen-Sartain	651.846.1766	jennie.sartain@saintpaul.edu

Communication Overview

Rhetoric is where the study of Communication began. By definition, rhetoric refers to oratory or persuasive speaking. The Communication faculty promotes the study and application of human communication and mass communication concepts and skills for work and life roles. Students enroll in Communication courses to fulfill Minnesota Transfer Curriculum requirements and graduation requirements.

Course		Cr
COMM 1710	Fundamentals of Public Speaking	3
COMM 1720	Interpersonal Communication 3	
COMM 1730	Intercultural Communication	3
COMM 1740	Mass Media and Communications	3
COMM 1750	Small Group Communication	3
COMM 1770	Family Communication	3
COMM 1780	Gender Communication	3
COMM 1790	Special Topics in Communication	1-6

Department Faculty

Anna Ignatjeva	651.846.1728	anna.ignatjeva@saintpaul.edu
Shelby Reigstad	651.846.1730	shelby.reigstad@saintpaul.edu
Daniel Paulnock	651.846.1662	daniel.paulnock@saintpaul.edu

English for Academic Purposes (EAP) Overview

The English for Academic Purposes (EAP) Program is designed to help English learners enter and succeed in the community and technical college system as well as in the transfer curriculum.

Courses in the EAP Program focus on speaking and listening, reading and vocabulary, writing and grammar, and pronunciation.

Students must complete or test out of High Intermediate and Advanced level courses in the EAP Program. Third semester options depend on a student's major and language ability. Some students may enroll in an English-EAPP Learning Community (LCOM), others may take READ 0722: Reading 2 and ENGL 0922: Fundamentals of Writing 2, and some may begin a career or technical program. Students will work with EAP Program Faculty and Advisors to choose the courses that best fit their needs and major requirements. Students interested in enrolling in the EAP Program must take the ESL ACCUPLACER test. This test assesses reading, listening and grammar ability.

Course*		Cr
EAPP 0760	High Intermediate Reading & Vocabulary	5
EAPP 0770	High Intermediate Writing & Grammar	5
EAPP 0780	High Intermediate Speaking & Listening	5
EAPP 0860	Advanced Reading & Vocabulary	5
EAPP 0870	Advanced Writing & Grammar	5
EAPP 0880	Advanced Speaking & Listening	5
Electives		Cr
EAPP 0900	Academic Reading and Writing	5
EAPP 1400	English Pronunciation for Academic and Professional Purposes	2
EAPP 1490	Special Topics in English for Speakers of Other Languages	1-6

Department Faculty

Barbara Kennedy	651.846.1317	barbara.kennedy@saintpaul.edu
Amy Tarrell-Florey	651.403.4029	amy.tarrell@saintpaul.edu

Fine Arts/Humanities

Art Overview

Art courses are designed to provide the highest quality coursework for students majoring in art as well as students who are interested in exploring their creative expression through the creation of artwork in a studio class or the study of art in a historical context. Our art coursework provides students with a richer understanding of the world and themselves. The instructors are committed to excellence in teaching and scholarship. The fine arts department offers a large variety of studio and art history coursework that transfers towards a major in art or art history at a four-year institution. Students who plan on majoring in art at a four-year institution should include art history, studio art and humanities coursework in order to be prepared for upper division work in whatever area of art they may choose to pursue. Art and art history classes fulfill requirements for the Minnesota Transfer Curriculum, as well as graduation requirements.

Course		Cr
ARTS 1713	Photography 1	3
ARTS 1714	Photography 2	3
ARTS 1717	Photography 3	3
ARTS 1720	Art Appreciation	3
ARTS 1722	American Animation	3
ARTS 1724	The Design of Everyday Life	3
ARTS 1726	Art in the Cities	3
ARTS 1730	Drawing 1	3
ARTS 1731	Drawing 2	3
ARTS 1732	Two-Dimensional Design	3
ARTS 1733	Three-Dimensional Design	3
ARTS 1740	Introduction to Painting	3
ARTS 1742	Intermediate Painting	3
ARTS 1744	Introduction to Watercolor Painting	3
ARTS 1750	Introduction to Ceramics	3
ARTS 1752	Intermediate Ceramics	3
ARTS 1756	Metal Arts	3
ARTS 1757	Metal Art 2	3
ARTS 1760	World Art	3
ARTS 1770	Art in America	3
ARTS 1780	Beginning Printmaking	3
ARTS 1790	History of Photography	3
ARTS 1795	Special Topics in Art	1-6
ARTS 2710	Advanced Studio Arts	3-4
ARTS 2754	Advanced Ceramics	3

Department Faculty

Aaron Bommarito	651.846.1664	aaron.bommarito@saintpaul.edu
Emily Hoisington	651.403.4431	emily.hoisington@saintpaul.edu
Aaron Jacobs	651.846.1763	aaron.jacobs@saintpaul.edu
Leigh Roethke	651.403.4023	leigh.roethke@saintpaul.edu

Drama and Theatre Overview

The Drama and Theatre Department course offerings cover both the theoretical and performance aspects of theatre. Students who enroll in Theatre courses fulfill the Minnesota Transfer Curriculum requirements as well as graduation requirements.

Course			Cr
THTR	1710	Introduction to Theatre	3
THTR	1716	Theatre Around the World	3
THTR	1725	Acting 1	3
THTR	1730	Theatre Stagecraft and Production	3
THTR	1731	Theatre Performance Practicum	1
THTR	1732	Technical Theatre Practicum	1
THTR	1740	Fundamentals of Playwriting: Playwriting 1	3
THTR	1790	Special Topics in Drama and Theatre	1-6
THTR	2725	Acting 2	3

Department Faculty

Jimmy LeDuc 651.403.4279 james.deluc@saintpaul.edu

Humanities Overview

Humanities courses promote the study of cultural developments. Students gain an increased understanding of the world they live in, how it came to be as it is, and what their place is in it. Students will be asked to consider how they can apply what they have learned about what has come before to what might occur in the future. Humanities is an interdisciplinary subject in that it is an exploration of the influence particular fields have on each other; for example, the influence of political movements on visual art, or the influence of religion on poetry of the same period. Fields included in the Humanities are: art, architecture, history, literature, philosophy, religion, politics, law, music, drama and language. Students are encouraged to make comparisons between different fields and different time periods and to consider the significance of similarities and differences. Humanities courses fulfill Minnesota Transfer Curriculum requirements and graduation requirements.

Course			Cr
HUMA	1720	The Ancient and Medieval World	4
HUMA	1730	The Modern World	4
HUMA	1750	Culture and Civilization: Spanish-Speaking Cultures	3
HUMA	1770	The Art of Film	3
HUMA	1780	American Film	3
HUMA	1790	International Film	3
HUMA	1795	Special Topics in Humanities	1-6

Department Faculty

Julia Haider 651.846.1686 julia.haider@saintpaul.edu
Leigh Roethke 651.403.4023 leigh.roethke@saintpaul.edu

Music Overview

The College offers Music courses to fulfill the Minnesota Transfer Curriculum requirements and graduation requirements.

Course			Cr
MUSC	1030	Applied Strings	2
MUSC	1310	Applied Voice	2
MUSC	1320	Applied Piano	2
MUSC	1701	Music Theory 1	2
MUSC	1702	Aural Skills 1	1
MUSC	1703	Music Theory 2	2
MUSC	1704	Aural Skills 2	1
MUSC	1720	Fundamentals of Music	3
MUSC	1730	Concert Choir	2
MUSC	1735	Classical Piano 1	2
MUSC	1736	Classical Piano 2	2
MUSC	1740	Music Appreciation	3
MUSC	1745	History of Rock and Roll	3
MUSC	1750	Jazz History	3
MUSC	1760	American Music	3
MUSC	1765	Music of Latin America and the Caribbean	3
MUSC	1770	Music in World Cultures	3
MUSC	1790	Special Topics in Music	1-6
MUSC	1800	Music Production 1	3
MUSC	2700	Music Theory 3	2
MUSC	2705	Aural Skills 3	1
MUSC	2710	Music Theory 4	2
MUSC	2713	Guitar Ensemble	2
MUSC	2715	Aural Skills 4	1
MUSC	2720	Music History 1: Medieval to Baroque	3
MUSC	2721	Music History 2: Classical to Modern	3
MUSC	2800	Music Production 2	3

Department Faculty

Linda Chacholiades 651.403.4141 linda.chacholiades@saintpaul.edu
Michael Krajewski michael.krajewski@saintpaul.edu
Michael Olsen 651.403.4164 michael.olsen@saintpaul.edu

Philosophy Overview

Philosophy, literally, is the love of wisdom. It is the search for truth and the asking of fundamental questions about our existence and relationship with the world and interaction with others. Philosophy includes the study of arguments, and the providing of evidence and reasons for making particular claims. The practice of philosophy teaches critical thinking and careful reflection; all courses encourage students to formulate pertinent questions and examine and create arguments. It is hoped that students will continue to use careful reasoning skills honed in philosophy classes as they continue in their education and in life. Areas of concentration within philosophy include logic, ethics, religion and the theory of knowledge. Philosophy is helpful for careers in law, teaching, business, medicine and many other fields. Philosophy courses fulfill a number of requirements for the Minnesota Transfer Curriculum and graduation requirements.

Course			Cr
PHIL	1700	Introduction to Philosophy	3
PHIL	1710	Logic	3
PHIL	1715	Philosophy of Scientific Reasoning	3
PHIL	1720	Ethics	3
PHIL	1722	Health Care Ethics	3
PHIL	1724	Environmental Ethics	3
PHIL	1742	Greek and Roman Mythology	3
PHIL	1750	Eastern Philosophy	3
PHIL	1760	World Religions	3
PHIL	1770	Feminist Philosophy	3
PHIL	1790	Special Topics in Philosophy	1-6

Department Faculty

James Andresen	651.846.1665	james.andresen@saintpaul.edu
Julie Haider	651.846.1686	julie.haider@saintpaul.edu
Jason Swartwood	651.403.4117	jason.swartwood@saintpaul.edu

Global Languages

American Sign Language (ASL) Overview

The American Sign Language (ASL) courses are central to the 30-credit American Sign Language Studies Certificate program which provides students with the knowledge and skills of American Sign Language (ASL), focusing on the uniqueness of ASL as a language, Deaf Culture and Deaf History. If you are interested in the American Sign Language Studies Certificate program, please see the Program Requirements Guide in the Liberal Arts Program section.

Not all ASL courses meet the MnTC goals. Students may reference the course descriptions to see if a course meets Minnesota Transfer Curriculum goals.

Course			Cr
ASLS	1411	American Sign Language 1	3
ASLS	1412	American Sign Language 2	3
ASLS	1413*	American Sign Language 3	3
ASLS	1414*	American Sign Language 4	3
ASLS	1415	American Sign Language 5	3
ASLS	1420	ASL Linguistics	4
ASLS	1430	Classifiers	3
ASLS	1435	Deaf Studies/Culture	3

ASLS	1443	ASL Fingerspelling and Numbers	3
ASLS	1446	ASL Non-Manual Markers	2
ASLS	1450	American Sign Language Semantics	3
ASLS	1469	Deaf Heritage of Minnesota	2
ASLS	1497	Special Topics in ASL	1-5

*Meets MnTC Goal 8

Department Faculty

Rania Johnson	rania.johnson@saintpaul.edu
---------------	-----------------------------

Chinese Overview

Chinese language courses are designed to develop a basic competency in Chinese speaking, listening, reading, and writing; an appreciation for cultural diversity; and the application of conversational Chinese to work and life roles. Students with two-years of high school Chinese are generally prepared for beginning courses while students with three to four years of high school Chinese are generally ready to enter intermediate courses. Students who enroll in Chinese courses fulfill the Minnesota Transfer Curriculum requirements as well as graduation requirements.

Guidelines for Placement in Chinese Courses Students with little or no background in Chinese

If you have little or no background in Chinese, you should register for CHIN 1710 Beginning Chinese 1, which is the first course in our Chinese language sequence.

Students with college-level study of Chinese

If you have taken Chinese courses at another higher education institution, you should have your transcripts evaluated in order to determine appropriate placement.

Students with high school level study of Chinese

If you have studied Chinese for one year or less in high school, enroll in CHIN 1710 Beginning Chinese 1.

If you have studied Chinese for two or more years in high school and can answer “yes” to three or more of the following questions, then you should make an appointment with the Chinese language instructor to determine your placement.

1. Did you study Chinese during your junior AND senior years of high school?
2. Did you graduate from high school during the past two years?
3. Did your teacher speak Chinese to you in class?
4. Did you complete written homework and written compositions in Chinese on a regular basis?

Course			Cr
CHIN	1710	Beginning Chinese 1	5
CHIN	1720	Beginning Chinese 2	5
CHIN	1790	Special Topics in Chinese	1-6

Department Faculty

Yan Wang	651.403.4435	yan.wang@saintpaul.edu
----------	--------------	------------------------

Spanish Overview

Spanish courses are designed to develop proficiency in Spanish speaking, listening, reading, and writing; an appreciation for cultural diversity; and the application of conversational Spanish to work and life roles. Beginning and Intermediate-level courses are offered. Students with two-years of high school Spanish are generally prepared for beginning courses while students with three to four years of high school Spanish are generally ready to enter intermediate courses. Students who enroll in Spanish courses fulfill the Minnesota Transfer Curriculum requirements as well as graduation requirements.

Guidelines for Placement in Spanish Courses Students with little or no background in Spanish

If you have little or no background in Spanish, you should register for SPAN 1710 Beginning Spanish 1, which is the first course in our Spanish language sequence.

Students with college-level study of Spanish

If you have taken Spanish courses at another higher education institution, you should have your transcripts evaluated in order to determine appropriate placement.

Students with high school level study of Spanish

If you have studied Spanish for one year or less in high school, enroll in SPAN 1710 Beginning Spanish 1.

If you have studied Spanish for two or more years in high school and can answer “yes” to three or more of the following questions, then you may take a placement exam.

1. Did you study Spanish during your junior AND senior years of high school?
2. Did you graduate from high school during the past two years?
3. Did your teacher speak Spanish to you in class?
4. Did you complete written homework and written compositions in Spanish on a regular basis?

Non-credit placement:

Students can determine whether they have the linguistic proficiency to enroll in our second, third, or fourth semester Spanish courses by contacting the instructor of the course in which they wish to enroll. Instructors at Saint Paul College have several years of experience to determine a beneficial level for the student.

For-credit placement: College-Level Examination Program(CLEP):

This exam has a fee and you can earn college-level credit provided you achieve a certain level of proficiency. Students scoring 50 or above on the CLEP can get 6 credits of electives. Students scoring 66 or above can get credit for SPAN 1710 and SPAN 1720. For more information on how to take the CLEP exam go to saintpaul.edu/CLEP.

Placement and credit recommendation based on CLEP scores:

CLEP score	Spanish Class student should take
34 or lower	Register for Span 1710 Beginning Spanish 1
35-44	Register for SPAN 1720 Beginning Spanish 2
45-54	Register for SPAN 1730 Intermediate Spanish 2
55-65	Register for SPAN 1740 Intermediate Spanish 2
66+	Credit for SPAN 1710 & SPAN 1720

These guidelines are subject to change. Please, make sure you are following the most current version.

Course	Cr	
SPAN 1710	Beginning Spanish 1	5
SPAN 1720	Beginning Spanish 2	5
SPAN 1730	Intermediate Spanish 1	5
SPAN 1740	Intermediate Spanish 2	5
SPAN 1790	Spanish for the Workplace	3
SPAN 1795	Special Topics in Spanish	1-6

Department Faculty

Angela De La Cruz 651.846.1560 angela.delacruz@saintpaul.edu

Social Science

Anthropology Overview

The Anthropology department offers courses that cover human nature and society in a global context. Students are exposed to the biological and cultural evolution of our species and the cultural worlds past, present and future. Forces that have shaped us and that we continuously shape are discussed within local, national and global perspectives. Students are encouraged to critically assess as well as celebrate the cultural diversity of our world. Anthropology courses fulfill Minnesota Transfer Curriculum requirements and graduation requirements.

Course	Cr	
ANTH 1710	Introduction to Cultural Anthropology	4
ANTH 1720	Introduction to Physical Anthropology	4
ANTH 1730	Gender and Culture in Global Perspective	3
ANTH 1790	Special Topics in Anthropology	1-6

Department Faculty

Shannon Trego 651.403.4074 shannon.trego@saintpaul.edu

Economics Overview

Economics is a social science that studies how our society can achieve economic goals. These goals are divided into two main areas of macroeconomics and microeconomics. Goals in macroeconomics are full employment, price stability, and economic growth. Macroeconomics uses theoretical tools, historical perspective, and modeling to understand the development and functioning of macroeconomic policy. Macroeconomics explores how policy advocated by economists and political advisors is implemented and with what degrees of success. Microeconomics analyzes the economic decisions made by individual firms, organizations, and people. Microeconomic goals are maximizing individual and societies benefits using limited resources. Microeconomics uses modeling to understand how and why our resource markets work and provides insights into policies that make them more efficient. Studying economics helps students in many fields by providing a framework on which to analyze changes that are affecting our collective future.

Course			Cr
ECON	1710	Introduction to the American Economy	3
ECON	1720	Macroeconomics	3
ECON	1730	Microeconomics	3
ECON	1790	Special Topics in Economics	1-6

Department Faculty

Peter Lawson 651.403.4064 peter.lawson@saintpaul.edu

Geography Overview

Geography studies places and human activities across the earth. Geographers often ask where? and why? The field focuses on the distribution and changes in the location of ethnicities, resources, transportation, land use, industries, climate, physical land formations, etc. Many geography courses have both physical environment and human/cultural components. The geography faculty often have a global and interdisciplinary approach. Geography courses fulfill a number of requirements for the Minnesota Transfer Curriculum, Education majors, Social Science disciplines, and government and international careers. Special topics and field study courses are added occasionally.

Course			Cr
GEOG	1700	Physical Geography	3
GEOG	1720	Human/Cultural Geography	3
GEOG	1740	World Geography	3
GEOG	1750	Minnesota Geography	3
GEOG	1790	Special Topics in Geography	1-6

Department Faculty

Shannon Trego 651.846.4074 shannon.trego@saintpaul.edu

History Overview

The History department promotes the study, teaching and analysis of historical developments which have created our present world. The historical past is studied so that students can better fulfill their work and life roles. The department offers survey courses in American history and the history of world civilizations; however, students are not required to take these survey courses in chronological order. Students who plan to major in History at a four-year institution are encouraged to take both the American and world history survey courses in order to be well-prepared for upper division coursework. History courses fulfill a number of requirements for the Minnesota Transfer Curriculum, as well as graduation requirements.

Course			Cr
HIST	1730	Contemporary World History	3
HIST	1745	U.S. History to 1877	4
HIST	1746	U.S. History to 1877	4
HIST	1750	Minnesota History	3
HIST	1760	History of World Civilizations to 1500	3
HIST	1761	History of World Civilizations since 1500	3
HIST	1770	History of Women in the United States	3
HIST	1773	African American History	3
HIST	2740	Immigration and Ethnic History of the United States	3
HIST	2780	Special Topics in History	1-6
HIST	2790	Historical Methods	2

Department Faculty

Kurt Korten Hof 651.846.1706 kurt.korten.hof@saintpaul.edu
Ayesha Shariff 651.846.1711 ayesha.shariff@saintpaul.edu

Political Science Overview

Political science is one of the most popular undergraduate majors preparing students for a wide variety of careers. It is also one of the most popular majors for those planning to attend law school. The political science faculty seeks to prepare students for advanced study by providing introductions to major areas of the discipline. Additionally, the faculty aims to prepare students for active and thoughtful citizenship.

Course			Cr
POLS	1720	Introduction to American Government	3
POLS	1740	Introduction to World Politics	3
POLS	1750	Introduction to Political Science	3
POLS	1760	Introduction to Political Philosophy	3
POLS	1790	Special Topics in Political Science	1-6

Department Faculty

James Andresen 651.846.1665 james.andresen@saintpaul.edu

Psychology Overview

Psychology is the scientific inquiry into human behavior and mental processes explaining the complexity of issues from both an environmental and biological perspective. Courses are offered that provide a foundation in core psychological areas. Students enroll in psychology to obtain a better understanding of human behavior in a variety of settings as well as for relevant preparation for nursing, business and other fields. Psychology courses fulfill the Minnesota Transfer Curriculum requirements and graduation requirements.

Course			Cr
PSYC	1710	General Psychology	4
PSYC	1720	Psychology Throughout the Lifespan	3
PSYC	1740	Abnormal Psychology	4
PSYC	1750	Introduction to Health Psychology	3
PSYC	1790	Special Topics in Psychology	1-6
PSYC	2720	Social Psychology	4

Department Faculty

Nora Gibbons	651.846.1708	nora.gibbons@saintpaul.edu
Stephanie Hazen	651.846.1769	stephanie.hazen@saintpaul.edu
Lisa Schmitz	651.846.1530	lisa.schmitz@saintpaul.edu

Sociology Overview

The Sociology faculty strive to promote social awareness, active citizenship and critical thinking within and beyond our own culture. Courses are designed to emphasize the importance of the sociological perspective in work and life roles in a global world. Many students take sociology courses to develop personal skills and to learn about other cultures and societies. Students enroll in sociology courses to fulfill Minnesota Transfer Curriculum requirements and graduation requirements.

Course			Cr
SOCI	1710	Introduction to Sociology	4
SOCI	1720	Social Problems	3
SOCI	1730	Sociology of Families and Relationships	3
SOCI	1740	Sociology of Work	3
SOCI	1760	Mass Media and Society	4
SOCI	1765	Sociology of Crime and Deviance	3
SOCI	1766	Juvenile Delinquency	3
SOCI	1772	Introduction to Criminal Justice	3
SOCI	1774	Introduction to Corrections	3
SOCI	1776	Probation, Parole and Alternative Sentencing	3
SOCI	1790	Special Topics in Sociology	1-6
SOCI	2720	Social Psychology	4

Department Faculty

Kris D'Meier	651.403.4069	kris.dmeier@saintpaul.edu
Jolene Sundlie	651.846.1709	jolene.sundlie@saintpaul.edu

Women's and Gender Studies Overview

The Women's and Gender Studies course and related coursework emphasizes collaborative learning across academic disciplines with a focus on women and gender relationships. Several courses in the Liberal Arts and Sciences include an emphasis on gender analysis that links the content. Students are encouraged to contact the Pathway Advisor for information on four-year colleges and universities that offer a major or minor in Women's and Gender Studies. Students enroll in Women's and Gender Studies and related courses to fulfill Minnesota Transfer Curriculum requirements as well as graduation requirements.

Course			Cr
WGST	1785	Foundations in Women's Studies	3
WGST	1790	Special Topics in Women's and Gender Studies	1-6
Related courses across the disciplines:			
ANTH	1730	Gender and Culture in Global Perspective	3
BIOL	1785	Biology of Women	3
ENGL	2776	Women Writers	3
HIST	1770	History of Women in the United States	3
PHIL	1770	Feminist Philosophy	3
SOCI	1730	Sociology of Families and Relationships	3
COMM	1780	Gender Communication	3

Department Faculty

Ayesha Shariff	651.846.1711	ayasha.shariff@saintpaul.edu
----------------	--------------	------------------------------

Course descriptions are alphabetized by program area:

Accounting	225	Humanities	261
American Sign Language	225	Individualized Studies	261
Anthropology	226	Interpreter/Transliterater Sign Language	261
Art	226	Massage Therapy	262
Automotive Service	228	Mathematics	263
Biochemistry	229	Medical Laboratory Technician	264
Biology	229	Medical Office	266
Business	231	Music	268
Business Technology	233	Natural Sciences	269
Cabinetmaking	233	Nursing Assistant/Home Health Aide	270
Carpentry	234	Pharmacy Technology	270
Center for Manufacturing and Applied Engineering	235	Philosophy	271
Chemistry	237	Phlebotomy	272
Child Development	238	Physics	273
Chinese Language	239	Pipefitting	273
CNC Toolmaking	239	Plumbing	275
College & Career Planning Success Strategies	240	Political Science	276
Communication	240	Practical Nursing	276
Computer Science	241	Psychology	278
Cosmetology, Nail Care and Esthetician Core Courses	244	Public Health	278
Culinary Arts	246	Reading	279
Culinary Arts - Wine	248	Related Welding	279
Digital Graphics and Interactive Multimedia	248	Respiratory Therapist	280
Economics	250	Sheet Metal	281
Electrical Technology	250	Sociology	282
Electromechanical Systems	251	Spanish	283
Engineering (Pre)	252	Supply Chain Logistics	283
English	253	Surgical Technology	283
English for Academic Purposes (EAP)	255	Theatre and Drama	284
Geography	256	Truck Technician	285
Global Studies	257	Welding Technology	285
Global Trade	257	Women's and Gender Studies	288
Health	257		
History	259		
Hospitality Management	260		
Human Resources	260		

Course descriptions are subject to change.
 The most current course descriptions are available at:
saintpaul.edu/CourseSchedule.

Course Descriptions

The following course descriptions are alphabetized by academic program area. Each course description includes a course number and title, description of the course, a listing of any required prerequisites and the number of credits. The credit listing includes the lecture, lab and/or on-the-job breakdown. For example, 4C/3/1/0 shows that the course is 4 credits with 3 credits of lecture, 1 credit of lab and 0 credits of on-the-job training. Minnesota Transfer Goals are indicated by (MnTC: Goal(s) "goal number").

Accounting

ACCT 1410 Introduction to Accounting

Introduces the fundamental accounting concepts and principles used to analyze and record business transactions. Topics include transaction analysis, double-entry accounting, and the accounting cycle process. Examples are drawn from service and merchandising organizations. 2C/2/0/0

ACCT 1511 Federal Taxation 1

Introduces students to the basic issues and concepts of taxation principles. Students observe federal tax laws as applied to the preparation of the Form 1040 and related schedules. Tax preparation software is utilized for case projects. (Prerequisite(s): ACCT 1411) 4C/4/0/0

ACCT 1512 Federal Taxation 2

Introduces students to the fundamentals of tax law regarding business federal income taxation. Planning issues of estates and gift taxation are part of this course. Tax preparation software is utilized for case projects. (Prerequisite(s): ACCT 1511) 4C/4/0/0

ACCT 1515 Payroll Processing

This course covers Federal and State laws related to compensation calculations, payment of salaries and wages, and related taxes. Also, included are hiring and termination laws. Topics include employment recordkeeping requirements, preparation of the payroll register, individual earnings records, and payroll related forms and reports. 3C/3/0/0

ACCT 1523 Accounting Computer Applications

Designed to combine the theory of financial accounting principles with accounting software applications. The course will cover the basic design of accounting software and students will develop an analytical understanding of its properties. Special emphasis will be placed on applying the theory of accounting to the practice of using an accounting software package. 3C/3/0/0

ACCT 2410 Financial Accounting

This course in financial accounting acquaints students with the concepts and practices of accounting to be able to interpret and analyze the financial accounting reports of economic entities. Topics include: economic context of accounting; introduction to basic financial statements, measurement fundamentals; analysis of financial statements; cash; receivables; inventories; investments in equity and debt securities; long-lived assets; current and long-term liabilities; stockholders' equity; and financial performance measurement. 4C/4/0/0

ACCT 2411 Intermediate Accounting

Intermediate Accounting Covers financial reporting using generally accepted accounting principles and concepts relating to income determination, revenue recognition and asset valuation. (Prerequisite(s): ACCT 1412) 4C/4/0/0

ACCT 2420 Managerial Accounting

This course provides an introduction to the role of financial and managerial information in planning and control decisions, and the role of the management accountant in the organization. It emphasizes the concepts and practices of management accounting including

cost behaviors, contribution margins, job, and process costing, budgeting, standard costs and variance analysis, and other managerial accounting best practices. Students analyze the management decision-making process via problem solving and case analysis. Understand the differences between managerial and financial accounting. 4C/4/0/0

ACCT 2530 Fundamentals of Non-profit Accounting

This course addresses the entity which is not concerned with a profit objective. About one-third of entities in the United States are non-profit. The course covers objectives and principles of reporting for the non-profit entity. (Prerequisite(s): ACCT 1412) 4C/4/0/0

ACCT 2540 Financial Modeling for Spreadsheets

Designed to unify financial accounting theory with financial functions and formulas. This course covers elements of financial modeling with the time value of money. Present value and future value concepts are defined and utilized in this course. (Prerequisite(s): ACCT 1411) 4C/4/0/0

ACCT 2591 Accounting Internship

A cooperative work-student program between Saint Paul College Accounting Program and a business facility to allow the student an employment-like experience. (Prerequisite(s): Instructor approval) Variable credits 2-8

American Sign Language

ASLS 1411 American Sign Language 1

Introduction to American Sign Language (ASL), a visual/gestural language used by the Deaf Community. Course covers sign vocabulary, sentence structures, dialogue formats through facial expressions and body movements used in signing. (MnTC: Goal 8) 3C/3/0/0

ASLS 1412 American Sign Language 2

A continuation of ASLS 1411, designed to expand students' conversational range from talking about themselves to talking about other people and activities, giving directions, describing people and making requests. (Prerequisite(s): ASLS 1411 with a grade of "C" or better) (MnTC: Goal 8) 3C/3/0/0

ASLS 1413 American Sign Language 3

A continuation of ASLS 1412, designed to expand students' comprehension and sign language production skills. Through meaningful communication contexts, students will use communicative functions which include locating things, asking for solutions, discussing life events and describing objects. Use of appropriate cultural behaviors and strategies for conversational management is stressed. Receptive and expressive fingerspelling and information about the deaf community will further enhance the learning process. (Prerequisite(s): ASLS 1412 with a grade of "C" or better) (MnTC: Goal 8) 3C/3/0/0

ASLS 1414 American Sign Language 4

A continuation of ASLS 1413 provides more complex ASL grammatical features, communicative functions and receptive fingerspelling and numbers. Cultural features will be stressed to develop competency and fluency in the language. (Prerequisite(s): ASLS 1413 with a grade of "C" or better) (MnTC: Goal 8) 3C/3/0/0

ASLS 1415 American Sign Language 5

This course is an ongoing instruction of American Sign Language covering communicative functions, sign vocabulary, fingerspelling, grammar and cultural aspects of the Deaf Community. At the completion of ASL 5, each student shall be able to use these language functions and conversational behaviors appropriately in ASL. (Prerequisite(s): ASLS 1414 with a grade of "C" or better) 3C/3/0/0

ASLS 1420 ASL Linguistics

Introduces students to the linguistics of American Sign Language (ASL). Students study the major features of language structures and the underlying knowledge for the social uses of American Sign Language. Content includes an examination of the structure of the physical signals of ASL, the customary patterns for combining them and the influence of signs on one another in connected discourse. (Prerequisite(s): ASLS 1414 with a grade of "C" or better) 4C/4/0/0

ASLS 1430 Classifiers

Introduces students to the fundamentals of American Sign Language (ASL) classifiers. Students will enhance and expand the use of classifiers in their expressive skills and the recognition of classifiers in their receptive skills. (Prerequisite(s): ASLS 1420 with a grade of "C" or better) 3C/3/0/0

ASLS 1435 Deaf Studies/Culture

This course is designed to help students understand and appreciate Deaf Culture and the Deaf Community. Deaf history, historical and modern-day perspectives, deafness and its impact, Deaf Culture/ Community characteristics, education, communication modes/ languages used by deaf people and the ramifications and impact of American Sign Language and Deaf Culture upon the lives of D/deaf people and other populations will be introduced. (MnTC: Goal 7) 3C/3/0/0

ASLS 1443 ASL Fingerspelling and Numbers

This course introduces the students to the fundamentals of fingerspelling/lexicalized fingerspelling and the complex rules and patterns of ASL numbers systems. This course develops expressive and receptive fingerspelling and number skills. Receptive skills focus on whole-word recognition, distinction among different number systems, phrase recognition, and identifying fingerspelled words and numbers in context. Expressive skills focus on the development of speed, clarity, and fluency. (Prerequisite(s): ASLS 1414 American Sign Language 4 with a grade of "C" or better.) 3C/3/0/0

ASLS 1446 ASL Non-Manual Markers

This course covers the non-manual aspect of the language. The use of the face, eyes and head to convey grammatical information will be covered. Students will analyze specific features. Other topics include ASL 'mouthing', showing emotion and inappropriate facial behaviors. (Prerequisite(s): ASLS 1420 with grade of "C" or better) 2C/2/0/0

ASLS 1450 American Sign Language Semantics

This course is designed to expand students' sign vocabulary by analyzing multiple-meaning words and various sign equivalents. Language learning activities will focus on nouns-verbs, sentence types, classifiers, inflection of verbs with temporal aspect and distributional aspect. (Prerequisite(s): ASLS 1414 with grade of "C" or better) 3C/3/0/0

ASLS 1469 Deaf Heritage of Minnesota

Covers the history of deaf people in Minnesota and its impact upon deaf and non-deaf Minnesotans. (Prerequisite(s): ASLS 1420 with a grade of "C" or better or instructor approval) 2C/2/0/0

ASLS 1497 Special Topics in ASL

A variable credit granting course that focuses on special topics in the area of American Sign Language and Deaf Culture. Courses are designed to accommodate the learning needs and interests of students. Each course syllabus focuses on specific content areas which may not be presented or are presented in-depth in other ASLS courses. Variable credits 1-5

Anthropology

ANTH 1710 Introduction to Cultural Anthropology

This course introduces students to the concept of culture, anthropological methods and theories, and the unity and diversity of the human species. Culture is the means by which human beings adapt to their environment, structure their societies, and give meaning to life. The course surveys the similarities and differences of the complex whole of human culture, including: subsistence strategies; economics; marriage, family and kinship; gender; political organization; inequality; religion; colonialism; and globalization. There is a focus on current issues and problems, and their relationship to societal and global matters. (Prerequisite(s): READ 0721 with a grade of "C" or better or appropriate assessment score) (MnTC: Goals 5 & 7) 4C/4/0/0

ANTH 1720 Introduction to Physical Anthropology

This course examines human biological evolution and variation from the perspective of morphological and cultural adaptation. Discussion addresses the basis of human biology, including genetics, physiology, population dynamics, and adaptive mechanisms. Primates and human ancestors are explored as a comparative model of contemporary human behavior and social organization. The frameworks and arguments of fossil and archaeological evidence are investigated. Modern human biological diversity and adaptations are analyzed, with attention to disease environments and misconceptions of "race." (Prerequisite(s): READ 0721 with a grade of "C" or better or appropriate assessment score) (MnTC: Goals 5 & 10) 4C/4/0/0

ANTH 1730 Gender and Culture in Global Perspective

This course examines how sex, gender, and sexuality are culturally constructed through social structures, and how these influence the biological distinctions of male, female, and intersex individuals. Through a comparative approach, we will survey gender roles, values, and relative rank in various socioeconomic levels, including hunter-gatherer, horticultural, pastoral, agricultural, and industrial. Other material to explore will include the intersection between gender, race, class, and sexuality; the origins and consequences of patriarchy; the impact of the global economy on gender identities and self-perceptions; gender, politics, and social change; and the status of women and men in different kinship systems and families, and the power that accrues to them. (Prerequisite(s): READ 0721 with a grade of "C" or better or appropriate assessment score) (MnTC: Goals 5 & 8) 3C/3/0/0

ANTH 1790 Special Topics in Anthropology

This course is designed to present additional or unique material and learning experiences within a specified discipline. The course will be based on student need, flexibility, and may be designed to meet various transfer and pre-major course requirements. Please see a current Course Schedule for complete course details. (Prerequisite(s): READ 0721 with a grade of "C" or better or appropriate assessment score.) (MnTC: Goal 5) Variable credits 1-6

Art

ARTS 1713 Photography 1

This is a course devoted to introducing photography as a medium of creative expression and visual communication. Students are introduced to 35mm film cameras and the techniques used in the darkroom to create black and white photographs. Initial assignments address technical proficiency and then the emphasis transitions towards creative exploration, aesthetics, and meaning. Classroom discussion will also establish a fundamental relationship between digital and film photography. A \$200 camera deposit will be collected from students who borrow a film SLR camera. The deposit will be refunded at the end of the semester provided the camera is returned undamaged and in suitable working condition. (Prerequisite(s): READ 0722 with a grade of "C" or better or appropriate assessment score) (MnTC: Goal 6) 3C/1/2/0

ARTS 1714 Photography 2

This is a course devoted to fostering the skills and proficiency established in Photography 1 and allows students to experience a more meaningful amount of time to produce a body of creative work concentrating on one topic or thematic element. The intention of this course is for each student to produce a unique, high-quality, photographic portfolio that showcases technical and conceptual understanding of the photographic medium with the artwork produced. The accompanying lab section will dictate whether the student continues working in a darkroom or transitions into the digital photography lab. A \$200 camera deposit will be collected from students who borrow a camera. The deposit will be refunded at the end of the semester provided the camera is returned undamaged and in suitable working condition. (Prerequisite(s): ARTS 1713 Photography 1 with a grade of “C” or better) (MnTC: Goal 6) 3C/1/2/0

ARTS 1717 Photography 3

Photography 3 will build on the foundational skills of photography as an art form learned in the first two semesters of Photography coursework. We will continue to emphasize composition, exposure, camera work and advanced printing techniques to further enhance the capability of personal expression available in the medium. The class will explore professional practices in photography, complete a collaborative assignment, explore advanced printing techniques and opportunities, and develop skills to produce a portfolio of high quality black and white or color photographs. (Prerequisite: ARTS 1714) (MnTC: Goal 6) 3C/1/2/0

ARTS 1720 Art Appreciation

This is an introductory “learning to look” course with the objective of developing students’ ability to see, understand and enjoy the visual arts. Examples of painting, sculpture and architecture from around the world will be viewed, discussed and analyzed in class. Students will also learn about the materials and processes of art making. Course includes visits to local art museum(s). (Prerequisite(s): READ 0721 with a grade of “C” or better or appropriate assessment score) (MnTC: Goal 6 & 8) 3C/3/0/0

ARTS 1722 American Animation

This course looks at animation as an art form and cultural product. We will consider animation within the contexts of American popular culture, media history and socio-political history. We will explore technical and aesthetic advancements from the early animation devices of the nineteenth century to the current and emerging digital technologies of today. Our studies will take us through the classic cartoons of Winsor McCay, Max Fleischer, The Walt Disney Company and Warner Bros. to the latest creations of Pixar and South Park Studios. (Prerequisite(s): READ 0722 with a grade of “C” or better or appropriate assessment score) (MnTC: Goals 6 & 7) 3C/3/0/0

ARTS 1724 The Design of Everyday Life

Design is a powerful cultural force that surrounds us wherever we go. This course provides students with the basic historical and analytical tools to understand the impact of design on our day-to-day lives, objects, communication materials and environments. Lessons will cover the main movements, trends and issues in design, from the end of the nineteenth century through today. Visual examples will range from furniture to advertisements, industrial design to digital media. (Prerequisite(s): READ 0722 with a grade of “C” or better or appropriate assessment score) (MnTC: Goals 6 & 7) 3C/3/0/0

ARTS 1726 Art in the Cities

This course takes an experiential approach to learning about the visual arts. Through visits to museums, galleries, studios and historic sites, students will become familiar with some of the cultural resources available in Minneapolis and Saint Paul. We will study art representing various media, artistic philosophies, historical contexts and the multiculturalism of the Twin Cities. Weekly readings, papers and a final project emphasize the development of critical thinking, visual

analysis, and writing skills. Students will be responsible for their own transportation. (Prerequisite(s): READ 0722 with a grade of “C” or better or appropriate assessment score) (MnTC: Goals 6 & 7) 3C/3/0/0

ARTS 1730 Drawing 1

This course will focus on techniques and strategies for improving observational drawing abilities. Through hands-on drawing exercises, students will learn to depict the world around them and the human form with greater accuracy. (MnTC: Goal 6) 3C/1/2/0

ARTS 1731 Drawing 2

This course continues the development of skills and techniques learned in Drawing 1. This course emphasizes observing relationships, line and value to enhance experimental and personal expression; introduces techniques for drawing in color, incorporates figure drawing, and includes the study of influential artists throughout the history of art, concentrating on contemporary means of expression. Students design art projects and complete a portfolio. (Prerequisite(s): ARTS 1730 Drawing 1 with a grade of “C” or better) (MnTC: Goal 6) 3C/1/2/0

ARTS 1732 Two-Dimensional Design

This course is a foundational study of the principles of two-dimensional design for an understanding of its nature and expressive possibilities, with the opportunity to develop a creative approach in working with its elements. This course will study basic approaches to understanding design, the elements of design and the principles of design through personal investigation. (MnTC: Goal 6) 3C/2/1/0

ARTS 1733 Three-Dimensional Design

This course is a foundation level study of the principles and elements of three-dimensional design. Students will use a variety of media and art techniques to explore three-dimensional design, form, line, plane, volume, mass, space, texture, light, and time. Projects emphasize a working creative method for problem solving in three-dimensions as well as a general knowledge of historical and contemporary design issues. (MnTC: Goal 6) 3C/2/1/0

ARTS 1740 Introduction to Painting

This course will introduce students to the materials and techniques of oil painting. Assignments will be geared towards improving one’s ability to paint from direct observation, depicting the natural world and the human form with greater accuracy, and integrating “color theory” into oil paintings. (MnTC: Goal 6) 3C/1/2/0

ARTS 1742 Intermediate Painting

This course will incorporate and further develop skills and techniques learned in Introduction to Painting, but will be more independent in nature. Each student will write a proposal for a cohesive body of work to be completed over the course of the semester, and will work towards developing a personal “style” of painting. Through a series of in-class group critiques, students will learn to analyze and critique works of art. (Prerequisite(s): ARTS 1740 Introduction to Painting with a grade of “C” or better) (MnTC: Goal 6) 3C/1/2/0

ARTS 1744 Introduction to Watercolor Painting

This course will introduce students to the practice of watercolor painting. Students will become familiar with the materials and terminology of the medium. They will learn to synthesize a variety of painting techniques into watercolor paintings of varying genres and styles. Students will develop an understanding of color theory, as it applies to watercolor painting, and will come to understand historical and contemporary issues pertaining to the medium. (MnTC: Goal 6) 3C/1/2/0

ARTS 1750 Introduction to Ceramics

This hands-on studio arts course will introduce students to the fundamentals of Ceramic Art. The primary emphasis will be the creation of functional ceramic pottery. Students will learn to make hand-built pottery and learn to “throw” pots on the pottery wheel. In addition to this, students will learn about trimming, glazing, kiln firing, and a variety of decorative techniques. (MnTC: Goal 6) 3C/1/2/0

ARTS 1752 Intermediate Ceramics

This hands-on studio arts course will continue to introduce students to the fundamentals of Ceramic Art. The course will also introduce contemporary practices in ceramic arts and investigate sculptural aspects of the medium. Half of the semester will include advanced wheel techniques and a continued concentration on throwing functional pots. In addition to this, students will continue learning about trimming, glazing, kiln firing, and become more proficient in decorative techniques. (Prerequisite(s): ARTS 1750 Introduction to Ceramics with a grade of “C” or better) (MnTC: Goal 6) 3C/1/2/0

ARTS 1756 Metal Arts

This course is an introduction to aesthetics, tools, and techniques of creating 3-d works of art through Tungsten Inert Gas (TIG) welding and other assembly techniques. This course covers: safety concerns while working in a metal shop, TIG weld welding, the correct use of filler rod, preparing, cutting, bending, finishing, and the significant properties of different metals. We will explore the creative uses of welding to convey meaning, composition, space, implied motion, creativity, metaphor, personal exploration, the organic elements of nature and the hard edges of human made objects while building a community of respectful artists. (MnTC: Goal 6) 3C/1/2/0

ARTS 1757 Metal Art 2

This course builds on the skills and techniques developed in Metal Arts 1. Students will use continue to master their use of tungsten inert gas (TIG) welding as well as be introduced to other assemble techniques. Students will be expected to be role models for good shop safety and etiquette as well as act a mentor for novice artist while continuing to explore their own personal meaning. Students will work as self-directed artist exploring composition, space, implied motion, creativity, metaphor, personal exploration, the organic elements of nature and the hard edges of human made objects. (Prerequisites: ARTS 1756 with a grade of 'C' or better.) (MnTC: Goal 6) 3C/1/2/0

ARTS 1760 World Art

What would you see if you suddenly found yourself in China, Nigeria, India or Mexico? How would the world look to you? For many of us, it would probably look very strange. One of the many ways to make our world familiar to us, whether we travel or not, is to try to understand a culture’s visual expression in architecture, sculpture, painting and other media. This class will view slides of artwork in a lecture/discussion format. We will then visit the Minneapolis Institute of Arts, twice, where we will be able to immerse ourselves in the cultures studied by examining the original artworks produced by these cultures. (Prerequisite(s): READ 0721 with a grade of “C” or better or appropriate assessment score) (MnTC: Goals 6 & 8) 3C/3/0/0

ARTS 1770 Art in America

This course is an introduction to art and architecture in North America from the Colonial period to the present. Art in America is united by common historical events and includes Native American culture and influences outside of America. We will explore patterns of cultural interchange with particular emphasis on colonialism, revolution, and the search for national identities. We will also examine the impact of historic and current social movements and politics on art in America. (Prerequisite(s): READ 0722 with a grade of “C” or better or appropriate assessment score) (MnTC: Goal 6) 3C/3/0/0

ARTS 1780 Beginning Printmaking

For centuries artists have used printmaking processes to create beautiful images on paper. This course is an introduction to the fundamentals of fine art printmaking. Students will be instructed in the following printmaking areas: monotype, collograph, dry point linocut, and woodcut. In-class projects will focus on hands-on learning and experimentation as students progress toward assembling a fine art print folio of their work. (MnTC: Goal 6) 3C/1/2/0

ARTS 1790 History of Photography

This survey course will focus on the art of still photography from the 19th century to the present. There is an emphasis on the work of artists, their processes, and the accompanying aesthetic movements occurring between the announcement of the Daguerreotype in 1839 and the beginning of the twenty-first century. As witnesses of popular culture, students will examine the interaction of photography with other visual art forms. The photographic print, as a means of artistic expression, will be discussed, including historic, social, and artistic movements. (Prerequisite(s): READ 0722 with a grade of “C” or better or appropriate assessment score) (MnTC: Goal 6) 3C/3/0/0

ARTS 1795 Special Topics in Art

This course is designed to present additional or unique material and learning experiences within a specified discipline. The course will be based on student need, flexibility, and may be designed to meet various transfer and pre-major course requirements. Please see a current Course Schedule for complete course details. (MnTC: Goal 6) Variable credits 1-6

ARTS 2710 Advanced Studio Arts

In the Advanced Studio Arts course students will build upon what they learned in Drawing 1, Introduction to Painting, or Fundamentals of Photography courses. The course will be independent in nature with students focused on developing their own personal artistic “style” in either drawing, painting or photography. Students will propose an idea for a body of work and will spend the semester creating a cohesive portfolio of images and writing an artist’s statement. The semester will culminate with a public exhibition of student work. (MnTC: Goal 6) Variable credits 3-4

ARTS 2754 Advanced Ceramics

This hands-on studio arts course will build on the proficiency that students have achieved in Introductory and Intermediate Ceramics. The Advanced Ceramics course will require a familiarity with the wheel and hand-building techniques with an emphasis placed on a semester-long ceramics project resulting in a sculptural, conceptual, or functional body of ceramic art work. The course will also expand on contemporary practices in ceramic arts and further investigate sculptural aspects of the medium. Students will become familiar with local ceramics artists and the greater Twin Cities ceramics community. (Prerequisite(s): ARTS 1752 Intermediate Ceramics with a grade of “C” or better) (MnTC: Goal 6) 3C/1/2/0

Automotive Service

AUTO 1415 Introduction to Automotive Technology

This course covers industry safety practices, service manuals and technical bulletins, communication skills, and the use of measuring instruments. Also covers automotive terminology and introductory automotive maintenance procedures. (Prerequisite(s): Admission to the Automotive Service Program – Co-requisite(s): AUTO 1430, AUTO 1510, AUTO 1530) 4C/0/4/0

AUTO 1430 Brakes

Covers the basic principles of the brake system. Emphasis will be placed on operation, diagnosis and repair of common types of braking systems. (Prerequisite(s): AUTO 1410) 4C/0/4/0

AUTO 1441 Alignment & Suspension

Covers the study of suspension and steering systems. The student will inspect, repair and adjust the suspension and steering systems on today’s cars and light trucks. (Prerequisite(s): AUTO 1430) 4C/0/4/0

AUTO 1510 Clutch/Driveline Manual Transmission

Standard automotive and light truck clutches are covered. Content includes design, adjustment, overhaul, diagnosis and repair on mechanical and hydraulic clutch systems. This course also covers operation and proper repair procedures of current manual transmissions used in late model vehicles. (Prerequisite(s): AUTO 1430) 3C/0/3/0

AUTO 1523 Four Wheel Drive Differential

Emphasizes the operation and proper repair procedures of current transfer cases, hubs and differentials in four wheel drive vehicles. (Prerequisite(s): AUTO 1510) 3C/0/3/0

AUTO 1530 Basic Electrical & Battery

Covers basic fundamentals of electricity and electronics, circuits, magnetism, resistance, coils, instruments, diodes and solid-state devices. Battery charging and testing is included. 3C/1/2/0

AUTO 1540 Basic Engine Management

Covers instruction on operation of the ignition system and maintenance of the ignition and fuel systems. This course focuses on the replacement of maintenance items such as spark plugs, distributor cap, ignition wire and air, fuel and emission filters. 3C/1/2/0

AUTO 1550 Heating & Air Conditioning

Focuses on the principles of heating and air conditioning. Topics include A/C types, the diagnoses of malfunctions and tests/repairs. Lab work is done on actual systems. During the lab, the student will test and repair vacuum and electrical controls, air flow distribution and heater system controls. (Prerequisite(s): AUTO 1530) 4C/0/4/0

AUTO 2410 Starting & Charging Systems

Covers overhaul of components such as starters and alternators. Complete system diagnoses and repair are also included. 3C/0/3/0

AUTO 2420 Electrical Accessories

Covers the operation and servicing techniques of chassis wiring, lights, instruments and headlight aiming. How to read and interpret wiring diagrams will also be included. 3C/0/3/0

AUTO 2430 Engine Theory & Repair

Covers disassembly, inspection, repair and reassembly of the internal combustion engine. Repair procedures such as the replacement of piston ring, engine bearings and valve grinding are covered. 4C/0/4/0

AUTO 2440 Engine Installation

Covers the removal and installation of complete engine assemblies, transfer of parts and removal and installation of accessories. 2C/1/1/0

AUTO 2450 Introduction to Auto Computers

Covers the operation of computer systems of engines using feedback carburetors and fuel injection. Sensors and actuators that operate in the system will be studied and tested. 2C/1/1/0

AUTO 2513 Fuel Systems

This course covers the fundamentals of carburetor and intake systems, maintenance and repair of the fuel system and emission controls. It also covers the use of 4 gas and 5 gas analyzers, scanners and other test equipment to troubleshoot and repair problems in computerized fuel systems. 3C/0/3/0

AUTO 2520 Engine Drivability

Covers application of knowledge and skills gained when studying engine, fuel, ignition and computer systems. 3C/1/2/0

AUTO 2530 Automatic Transmission Theory

Covers the basics of torque converters, planetary gear sets, clutches, bands and hydraulics. 2C/1/1/0

AUTO 2542 Automatic Transmission Diagnosis & Repair

Covers automatic transmission and transaxle diagnoses and service. Trouble shooting and repair procedures will also be covered. 4C/2/2/0

AUTO 2550 Specialized Lab 1

Covers the content goals listed or any other goals that the student and the instructor agree upon. The purpose of the course is for students to specialize in an area they prefer. (Prerequisite(s): Completion of all other listed courses) 2C/1/1/0

Biochemistry

BIOC 1730 Biochemical Laboratory Exploration

This course introduces students to procedures and guidelines relating to chemical, biological, physical, and biomedical research. Students will gain an understanding of good laboratory practices, intellectual property, standard operating procedures, clinical research practices, and lab safety. Students will also learn to communicate in a scientific manner. The lab component of the course will provide hands-on experience with the laboratory environment, clean room environment, and instrumentation used in scientific laboratories. (Prerequisite(s): CHEM 1711 or BIOL 1740 with a grade of "C" or better) (MnTC: Goal 3) 4C/3/1/0

BIOC 1790 Special Topics in Biochemistry

This course is designed to present additional or unique material and learning experiences within a specified discipline. The course will be based on student need, flexibility, and may be designed to meet various transfer and pre-major course requirements. Please see a current Course Schedule for complete course details. (MnTC: Goal 3) Variable credits 1-6

BIOC 2700 Biochemistry

This course includes structure and function of proteins, carbohydrates, nucleic acids, and lipids. Action and regulation of major metabolic pathways. Synthesis and degradation of biomolecules. Enzyme energetics, kinetics, and chemical basis for transmission of genetic information will also be discussed. Lab work will utilize applied biochemical techniques to reinforce topics covered in the lecture. This includes protein and lipid assays, examinations of metabolism, and analysis of sugars. Lab work will be designed to give the student experience using modern biochemical techniques and equipment. Responsible record keeping and conduct will also be emphasized. (Prerequisite(s): CHEM 2720 and BIOL 1740 with a grade of "C" or better or instructor permission) (MnTC: Goal 3) 4C/3/1/0

BIOC 2790 Biochemistry Internship/Research Project

This course provides students with an opportunity to design and carry out a research project under the supervision of a faculty advisor utilizing biochemistry in a lab setting. The research project will be prepared using literature review, problem identification, procedural documentation, data collection, data analysis, findings, conclusions, and recommendations for future research. The course will also provide an opportunity for field study in an approved internship setting. Evaluation will be carried out by faculty teams and experts in the field. (Prerequisite(s): Instructor approval) (MnTC: Goal 3) Variable credits 1-4

Biology

BIOL 1471 Medical Terminology

This online course covers how bio/medical terms are constructed from Greek and Latin word elements including roots, combining forms, prefixes, and suffixes. Definitions, spelling, pronunciation, and applications of these terms will be stressed. Diseases and treatments specific to the body's organ systems will also be covered. This course is useful for anyone who desires a better understanding of medical language. (Prerequisite(s): READ 0721 with a grade of "C" or better or appropriate assessment score) 2C/2/0/0

BIOL 1725 Environmental Science

This course covers basic scientific and ecological principles, including an understanding of how the earth functions, how humans are affecting the earth, and proposed solutions to many of the environmental problems we face. Specific topics include: ecology, human population growth, biotechnology, pollution, human impacts on climate, energy resources, and waste management. Students will be required to take positions on environmental issues and alternative future scenarios. In-class activities will include group discussions and video and the use of internet-based resources. Two hours of lab per week are required and include group experiments, computer simulations, outdoor lab activities, and field trips. Traditional, hybrid, and online sections are available. (Prerequisite(s): READ 0721 with a grade of "C" or better or appropriate assessment score) (MnTC: Goals 3 & 10) 4C/3/1/0

BIOL 1730 Human Body Systems

This course begins with a study of the structural organization of the human body and then proceeds with the study of cell structure, types of tissues and basic anatomy and physiology of major organ systems of the human body. The central theme will focus on how the body systems work together to maintain homeostasis and good health. Laboratory activities include the dissection of a preserved animal and animal organs. The course is intended for all interested students and required for programs like Medical Laboratory Technician, Practical Nursing, Respiratory Therapy Technician, and Pharmacy Technician. Traditional and hybrid sections are available. Two hours of lab per week are required. (Prerequisite(s): READ 0721 with a grade of "C" or better or appropriate assessment score) (MnTC: Goal 3) 3C/2/1/0

BIOL 1735 Understanding Biology

This course is designed for non-science majors or as a preparation for BIOL 1740. A basic introduction to the principles of cell biology and genetics will be covered. The course will also examine the plant and animal kingdoms and general principles of ecology and evolution. One main goal of this course is to provide students with an understanding of biology that will allow them to evaluate and make informed opinions about related current events. Two hours of lab per week are required. (Prerequisite(s): READ 0721 with a grade of "C" or better or appropriate assessment score) (MnTC: Goal 3) 4C/3/1/0

BIOL 1740 General Biology 1: The Living Cell

This course is a study of biological processes including cell chemistry, metabolism, reproduction, genetics, and complex cell physiology. The lab component covers the application of concepts through observation, experimentation, and problem analysis. This course is intended for biology majors and students requiring a strong biological background for selected majors, including nursing and other allied health fields, and interested non-majors. BIOL 1740 is a prerequisite for BIOL 2721 Human Anatomy and Physiology 1, BIOL 2750 General Microbiology, and BIOL 1745 General Biology 2: The Living World. Traditional, hybrid and online sections are available. Three hours of lab per week are required. (Prerequisite(s): READ 0722 with a grade of "C" or better, or concurrent enrollment, or appropriate assessment score.) (MnTC: Goal 3) 5C/4/1/0

BIOL 1745 General Biology 2: The Living World

This course covers biological processes, including a survey of life forms (viruses, bacteria, protists, fungi, plants, and animals), their evolution, and ecology. The laboratory focuses on organism taxonomy, classification, and mammalian systems including comparative anatomy, organism dissections, ecological interrelationships of organisms and their environment. Three hours of lab per week are required and some activities involve the dissection of preserved animals and animal organs. Traditional, hybrid and online sections are available. (Prerequisite(s): BIOL 1740 General Biology 1: The Living Cell with a grade of "C" or better) (MnTC: Goals 3 & 10) 5C/4/1/0

BIOL 1760 Nutrition

This course explores the science of nutrition, including healthy diet fundamentals and the roles of carbohydrates, proteins, fats, vitamins, and minerals in health and fitness. Topics such as dietary guidelines, risk factors for illnesses linked to nutrition, and how the media influences personal diet choices will be covered. Hunger and the global environment as it relates to nutrition will also be covered. This course includes hands-on, lab-like activities related to nutrition and health. Traditional, hybrid, and online sections are available. (Prerequisite(s): READ 0721 with a grade of "C" or better or appropriate assessment score) (MnTC: Goal 3) 3C/3/0/0

BIOL 1782 Introduction to Forensic Science

This course provides an introduction to Forensic Science. General biological concepts and their applications to various scientific principles and techniques used in Forensic Biology will be covered. Specific topics include chromatography, hair and fiber analysis, fingerprinting, blood spatter and typing, DNA typing, and forensic entomology. This course is intended for students in liberal arts and sciences, other related science fields, and interested non-science majors and can be used to fulfill the science lab requirement. Two hours of lab per week are required. Traditional, hybrid and online sections are available. (Prerequisite(s): READ 0721 with a grade of "C" or better or appropriate assessment score) (MnTC: Goal 3) 4C/3/1/0

BIOL 1785 Biology of Men and Women

This course is designed to allow students to explore significant facets of woman from many different angles across her life span from conception, through puberty, pregnancy, birthing and aging including specific health concerns ranging from osteoporosis, breast cancer, heart disease mental disorders and other chronic illnesses. Topics that will be covered include reproductive anatomy and physiology of sexes, sexual development and response, genetics, pregnancy, childbirth, reproductive issues & advances in assisted reproductive technologies which include contraceptive methods, infertility, impotency and sexually-transmitted diseases. Open to both male and female students, meant for non-science majors. (Prerequisite(s): READ 0721 with a grade of "C" or better or appropriate assessment score) (MnTC: Goals 3 & 9) 3C/3/0/0

BIOL 1790 Special Topics in Biology

This course is designed to present additional or unique material and learning experiences within a specified discipline. The course will be based on student need, flexibility, and may be designed to meet various transfer and pre-major course requirements. Please see a current Course Schedule for complete details. (MnTC: Goal 3) Variable credits 1-6

BIOL 2721 Human Anatomy and Physiology 1

This course covers body organization, tissues, human body systems (integumentary, skeletal, muscular and nervous), and the special senses, integrating both the anatomy and physiology of each organ system. Dysfunctions may be included, but the body in homeostasis is emphasized. Two hours of lab per week are required. Some lab activities involve the dissection of preserved animal organs. Traditional and hybrid sections are available. (Prerequisite(s): BIOL 1740 General Biology 1: The Living Cell with a grade of "C" or better) (MnTC: Goal 3) 4C/3/1/0

BIOL 2722 Human Anatomy and Physiology 2

This course covers those body systems not included in Human Anatomy & Physiology 1: cardiovascular, respiratory, reproductive, urinary, endocrine, digestive, and lymphatic/immune systems. The anatomy and physiology of each organ system is integrated. Dysfunctions may be included, but the body in homeostasis is emphasized. Two hours of lab per week are required. Many lab activities involve dissection of a preserved animal and animal organs. Human cadavers are also studied for two hours. (Prerequisite(s): BIOL 2721 Human Anatomy and Physiology 1 with a grade of "C" or better) Traditional and hybrid sections are available. (MnTC: Goal 3) 4C/3/1/0

BIOL 2750 General Microbiology

General Microbiology covers bacteria, fungi, protozoa, algae, and viruses. Structure, metabolism, growth requirements, genetics, and replication of these microbes will be compared. Emphasis will be placed on the role of microbes in human disease and the function of the immune system in microbial control and balance. Environment and industrial microbiology will also be discussed. Three hours of lab per week are required and sessions will be structured to provide a hands-on introduction to common laboratory techniques related to topics covered in lecture. Safety and infection control will also be stressed. (Prerequisite(s): BIOL 1740 General Biology 1: The Living Cell with a grade of "C" or better) Traditional and hybrid sections are available. (MnTC: Goal 3) 4C/3/1/0

BIOL 2755 Genetics

Traditional and modern principles of genetics will be investigated through problem solving, molecular modeling and group discussion. The course will include exploration of genetics at the cellular and organismal level with special emphasis on human genetics. Students will have the opportunity to design and present research using genetic laboratory techniques. (Pre-requisite(s): BIOL 1740) 4C/3/1/0

BIOL 2760 Cell and Molecular Biology

This course is designed for Saint Paul College students interested in Biomedical or Biotechnology sciences as part of their core curriculum. It is also open to any student interested in the fields of cell biology and molecular genetics. Through laboratory investigations, students will learn the current concepts and techniques in molecular biology for a better understanding of the cell. Students will also learn the use of National Center for Biotechnology Information (NCBI) website for the analysis of genetic sequence and applying their findings to the treatments and cure of human disease, agricultural improvement, forensic science and a better understanding of evolution. Ethical and moral issues posed by molecular biotechnology will be explored and discussed. (Prerequisite(s): BIOL 2750 General Microbiology with a grade of "C" or better) (MnTC: Goal 3) 5C/4/1/0

BIOL 2770 Biology Internship

This course provides students with an opportunity to design and carry out a science research project under the supervision of a faculty advisor. The research report will be prepared using literature review, problem identification, procedural documentation, data collection, data analysis, findings, conclusions, and recommendations. Evaluation will be carried out by faculty teams and experts in the field. The course will also provide an opportunity for field study in an approved internship setting. (Prerequisite(s): Instructor approval) (MnTC: Goal 3) Variable credits 1-4

Business

BUSN 1410 Introduction to Business

Offers an introduction to the United States business system. Students will explore economic principles, international business, business ethics, marketing and financial principles. 3C/3/0/0

BUSN 1441 Consumer Behavior

This course will explore the behavior of consumers as it relates to products and services. The role of the consumer in the marketplace will be examined including the analysis of needs, motivation, attitudes, perceptions, decisions, and behavior. 3C/3/0/0

BUSN 1444 Advertising and Promotional Strategies

This course explores the world of advertising and other mass communications practices. It will examine advertising theory, functions and principles. All types of media will be explored, including television, radio, magazine, newspaper, outdoor and the internet. Various careers in advertising will be examined. 3C/3/0/0

BUSN 1446 Sales and Account Management

In this course we will examine the personal selling process. We will explore the practical and tactical process of how to sell products and services in a complex market. We will also examine sales force training, compensation, territory assignment and quotas. 3C/3/0/0

BUSN 1449 Business Communications

This course presents an overview of the challenges associated with workplace expectations regarding business etiquette, appropriate use of technology, and proper attire. It assists students in gaining knowledge of how to appropriately communicate with others and how to effectively deal with conflict, teamwork, and accountability in a fair and ethical manner. It also enhances the basic skills necessary for obtaining a job and achieving success in today's challenging economy and increasingly competitive work environment. 3C/3/0/0

BUSN 1480 Business Career Resources

This course provides information and guidance in the development of professional job seeking skills. Topics will include: the application, the resume, the cover letter, using the Internet in a job search, locating job opportunities, marketing yourself and company research. 1C/1/0/0

BUSN 1490 E-Marketing

The Internet and other technologies have created many opportunities for businesses and organizations to communicate and create value for their customers. This course is designed to give students an understanding of E-Marketing strategies and how they fit into an overall integrated marketing and communications plan. Topics include direct marketing, internet advertising, performance analytics, search engine optimization and career opportunities in E-Marketing. 3C/3/0/0

BUSN 1492 Social Media Marketing

In this course students will learn successful marketing strategies using social media as an essential part of an integrated marketing strategy. Social media provides both a listening and outreach tool for promoting business, products and ideas. Social media ethics, legal issues and best practices will be covered. Various social media platforms such as Facebook, Twitter, YouTube and LinkedIn will be explored, as well as careers and jobs in Social Media Marketing. Students will analyze contemporary social media cases and strategies and develop a comprehensive social media marketing plan. Other topics include target marketing on the social web and rules of engagement. 3C/3/0/0

BUSN 1520 Customer Service

This course will present effective functioning in a service economy. Students will define and describe the nature, characteristics, and ways services need to be presented using basic customer service terminology. Students will learn skills to create positive customer relations. 3C/3/0/0

BUSN 1760 Principles of Finance

Principles and practices of business finance to help decision makers in a dynamic economy. Focus is placed on reviewing and analyzing financial statements, the time value of money, cash flow management, and risk and return. 4C/4/0/0

BUSN 1762 Money and Banking

This course provides an introduction to money and banking and presents a fundamental treatment of how money functions in the United States and world economies. It introduces the concept of money supply and the role of banks as money creators and as participants in the nation's payments mechanism. The course explores the working of fiscal and monetary policy, the functions and powers of the Federal Reserve System, and various monetary theories. Also highlighted are major trends and issues in banking and international banking. 4C/4/0/0

BUSN 1782 Investments

This course provides a study of the core concepts of investments for Finance majors. It broadly covers financial instruments, such as equity, fixed income, and derivative securities, as well as key concepts studied in Principles of Finance. (Prerequisite(s): BUSN 1760 Principles of Finance) 3C/3/0/0

BUSN 1784 Principles of Risk Management and Insurance

This course examines the nature of risk and how it can be managed. Insurance is one of the tools used to respond to risk. It will be examined along with a multitude of other options that are available for risk management. (Prerequisite(s): BUSN 1760 Principles of Finance) 3C/3/0/0

BUSN 2110 Principles of Marketing

Students will develop an understanding of the basic principles of marketing. Students will examine core marketing concepts (needs, wants and demands) and the elements used in developing a marketing plan, including consumer behavior principles, direct and online marketing, pricing strategies, advertising, sales promotion, public relations, personal selling and product distribution. Current marketing trends will be discussed. 3C/3/0/0

BUSN 2410 Critical Thinking for Business Decision Making

This course will cover theory and application of critical thinking. Students explore the various elements of the critical thinking process and understand the importance of effective critical thinking skills in the 21st century workplace. Emphasis is placed on learning how to use critical thinking to challenge assumptions and expand perceptions about situations, as well as applying improved skills to the day-to-day operations of a business. 2C/2/0/0

BUSN 2440 Fundamentals of Nonprofit Management

This course explains the foundation of the nonprofit sector. Students will be introduced to the fundamentals of effective organization mission and vision statements, strategic planning, operations management, board development and budgeting. Students will gain understanding of different aspects of the nonprofit organization. 3C/3/0/0

BUSN 2441 Fundraising Techniques

Learn the role of the board and staff in fundraising, setting fundraising goals, and the cultivation and recognition of donors. This course also covers other components of fundraising for successful generation of revenue. 1C/1/0/0

BUSN 2442 Grant Writing and Research

Learn the tactics of researching and writing effective proposals. Discover the best ways to develop documentation, write compelling inquiry letters and set goals that can be achieved. 1C/1/0/0

BUSN 2443 Dynamics of Board Relations

Develop a better board of directors or become a better board member. Boards of directors of nonprofits are often unclear about their role and relationship with staff and the executive director. This course defines the role of the board and strengthens the working relationship between staff members and board members. 1C/1/0/0

BUSN 2444 Volunteer Program Management

Volunteers make it happen! Successful management of this important asset is critical to an organization. Learn the basic principles and concepts of professional volunteer management and gain a solid foundation on which to build. 1C/1/0/0

BUSN 2445 Nonprofit Law and Ethics

Gain knowledge of the complexities of nonprofit organizations. Learn about the legal aspects of nonprofit and tax exempt organizations under federal and state law. Areas discussed include incorporation, exemption, reporting requirements and various IRS mandates for 501(c)(3) exemptions. Ethical issues and concepts as they relate to nonprofit business will be discussed. 1C/1/0/0

BUSN 2450 Management Fundamentals

The course includes the history of management theory with emphasis on forces of change that have resulted in a changing view of the business world for managers. Principal management functions covered are planning, organizing, leading and the process of control as an information feedback function for increasing productivity. Emphasis is on the integration of all management functions into one effort for visionary, effective and efficient operations. 3C/3/0/0

BUSN 2455 Essentials of Entrepreneurship and Small Business Management

In this course the student will learn the essential skills needed to start and manage a successful new business venture. Topics include: the challenge of entrepreneurship, building a business plan, marketing and financial issues with a start-up company and how to gain a competitive advantage. 3C/3/0/0

BUSN 2459 Family and Personal Financial Planning

This course offers practical methods for managing individual personal and family finances. Tools, software and strategies will be explored to encourage responsible financial well-being. Students will write a financial plan consistent with individual goals and values that incorporate the areas studied in the course. 4C/4/0/0

BUSN 2464 Leading and Coaching Others

This course focuses on developing skills as a leader and coach. The students will explore a variety of coaching tools, techniques and best practices, from analyzing performance to creating a climate for effective coaching and learning. Some of the coaching and leadership topics include improving skills for developing trust, confidence, and rapport. The course also explores obstacles of coaching and provides tools for overcoming the obstacles. 2C/2/0/0

BUSN 2465 Business Ethics

This course introduces students to ethical issues and concepts as they relate to business and as they impact society, the economy and the environment. Students will analyze various approaches to making ethical decisions through case studies. Topics range from the role of the government to corporate global businesses. Both national and international ethics will be discussed. 3C/3/0/0

BUSN 2466 Managing Change and Conflict

This course helps students to learn and develop the unique set of skills and competencies used to initiate and sustain major organizational change. Students explore techniques for working collaboratively with others to drive organizational culture change. Emphasis is also placed on effectively managing conflict and provides opportunity to develop a list of tools and resources used in conflict management. 2C/2/0/0

BUSN 2470 Legal Environment of Business

This course covers basic information about the various classifications of the law and the rights and responsibilities imposed on the business community by our legal system. The course introduces students to the legal system and its impact on the individual, the business environment and upon society as a whole. Areas of study include basic laws, contracts, negligence, product liability, employment law, alternative dispute resolution and business entities. 3C/3/0/0

BUSN 2472 Business Negotiation Skills

Covers techniques and unique circumstances for the negotiation of prices in the business environment. The course will guide students through the areas of risk negotiations, bargaining concepts, strategy and tactics for successful contract negotiations. 3C/3/0/0

BUSN 2473 Project Management

This course is an introduction to project management. The course emphasizes the relationship of project management techniques to business decisions. Project management processes for initiating, planning, executing and closing down projects are covered. Specific techniques covered include work breakdown schedules, resource

leveling, risk identification, contingency planning and other skills are covered. Each student will conduct a series of case studies using Microsoft Project as project management tools. 3C/3/0/0

BUSN 2480 Business Management Internship

A cooperative work-study program between Saint Paul College—A Community & Technical College Business Management degree program and a business facility. This elective course allows the student to experience a closely supervised job situation that is related to the program. (Prerequisite(s): Instructor approval) Variable credits 1-3

BUSN 2482 Entrepreneurship Capstone

Students will complete a business plan. A business plan integrates skills and elements from various disciplines. Because a business plan is a complete and professional document that establishes the viability of your business ideas, students will build both their writing and presentation skills. 3C/3/0/0

Business Technology

BTEC 1121 Introduction to Microsoft Word

This course provides an overview of the most commonly used features of Microsoft Word. Students will examine word processing concepts and use Microsoft Word to create and edit documents for professional, personal, and academic use. 1C/1/0/0

BTEC 1131 Introduction to Microsoft Excel

This course provides an overview of the most commonly used features of Microsoft Excel. Students will identify spreadsheet terminology and concepts, create formulas and functions, and create and edit spreadsheets, charts, and graphs for professional, personal, and academic use. 1C/1/0/0

BTEC 1151 Introduction to Microsoft PowerPoint

This course provides an overview of the most commonly used features of Microsoft PowerPoint. Students will identify presentation terminology and concepts. Students will create and edit presentations for professional, personal, and academic use. 1C/1/0/0

BTEC 1400 Keyboarding

Covers “Touch Keyboarding” skill development on a computer keyboard. A variety of drills will be used to develop speed and accuracy of keyboarding skills. 2C/1/1/0

BTEC 1410 Advanced Keyboarding Applications

Covers continued development of keyboarding speed and accuracy and proofreading skills. Students will develop skill in formatting and production of the following documents: memos, letters, envelopes, tables, and reports. Students will be tested on the first day of class to determine two requirements: 1) Accurate keyboarding speed of 30 wpm, and 2) Using the touch method. 3C/1/2/0

BTEC 1418 Computer Fundamentals

This course covers introductory information about computer hardware and software, working with drives, folders and files, and the use of the microcomputer as a productivity tool. Students will be given introductory training in Microsoft Windows, Microsoft Office (word processing, spreadsheets, graphs, database and presentation applications) and Internet usage. 3C/3/0/0

BTEC 1421 Business Information Applications 1

This is the first course in a series that teaches students how to use Microsoft Office software applications. Software covered includes Word, Excel, Access, and PowerPoint. By the end of this course, students will be skilled in the basic features of Microsoft Office. Students will create common business documents including letters, reports, tables, newsletters, Excel worksheets, Access databases, and PowerPoint graphic presentations. This course, BTEC 1423 Business Information Applications 2 and BTEC 2506 Business Information

Applications 3, prepare the student for the Microsoft Office Specialist (MOS) certification exams. (Prerequisite(s): Knowledge of computers) 3C/0/3/0

BTEC 1423 Business Information Applications 2

This is the second course in a series that teaches students how to use Microsoft Office software applications. Software used includes Word, Excel, Access, and PowerPoint. By the end of this course, students will be skilled in the advanced features of Microsoft Office. Students will create advanced business documents including Word form letters, merged documents, and newsletters; Excel financial worksheets, amortization schedules, and data tables; advanced Access queries, multi-table forms, customized reports and switchboards; and advanced PowerPoint presentations. This course, BTEC 1421 Business Information Applications 1 and BTEC 2506 Business Information Applications 3, prepare the student for the Microsoft Office Specialist (MOS) certification exams. (Prerequisite(s): BTEC 1421) 4C/0/4/0

BTEC 1530 Communication Technology

This course offers hands-on instruction in current communication technology software. Topics in this class will cover the fundamentals of Microsoft Outlook, Microsoft Publisher, and creating web pages. In Microsoft Outlook, the students will create messages, contact lists, and manage calendars. In Microsoft Publisher, the student will create and edit a publication, design a newsletter, publish a tri-fold brochure, and create an e-mail letter. Students will also learn how to create a simple website, add text and links, and create tables. 4C/0/4/0

BTEC 2410 Business Procedures

This course covers topics that develop skill in performing typical office tasks: telephoning, mailing, filing, calendaring, meeting arrangements, travel arrangements, office equipment care, time management, document production, reprographics and creating reports and financial records. Through the use of interactive software and projects, the student will experience daily routines, make decisions, set priorities, deal with work pressures, develop interpersonal relationships and become aware of work quality and quantity requirements. 4C/4/0/0

BTEC 2506 Business Information Applications 3

This is the third course in a sequence that explores expert level applications using Microsoft Office software. This course assumes students are familiar with the fundamental and advanced features of Microsoft Word, Excel, Access, and PowerPoint. Students demonstrate proficiency in Microsoft Office in preparation for the Microsoft Certified Applications Specialist certification exams. Students create expert level documents, worksheets, databases, and presentations suitable for the business environment, coursework, and personal use. (Prerequisites(s): BTEC 1423) 4C/0/4/0

BTEC 2590 Business Technology Internship

A cooperative work-study program between Saint Paul College Business Technology programs and a business facility. This course allows the student to experience a closely supervised job situation that is related to the program. (Prerequisite(s): Instructor approval) Variable credits 2-8

Cabinetmaking

CABT 1450 Print Reading

Introduces student to: blueprint reading, building trade drawings, architectural graphics, and symbols used in the trade, as well as an understanding of what a drafting person does. 2C/1/1/0

CABT 1455 Traditional Machining Methods

This course will introduce students to shop safety. The student will study the identification, care and use of hand tools, portable power

tools, and machinery. The course offers safety demonstrations on all power equipment and safety tests will be performed on most machines. Basic knowledge of power and hand tools is required. Students will master the machinery through building various projects. 5C/2/3/0

CABT 1460 Wood Technology

This course will introduce students to the materials and finishes used in cabinetmaking. Students will learn to identify hardwoods, softwoods and manufactured panel products, and the grading of these products. Students will also learn about abrasives, adhesives, fasteners, and clamping devices. The second half of this course will cover the types of finishes used in cabinetmaking and how they are applied. 2C/1/1/0

CABT 1465 Furniture & Residential Cabinetry

This course introduces the student to face frame base and upper cabinetry. Students will learn the design, planning, and construction processes of building face frame cabinets. The student will then apply these techniques by building a project. (Co-requisite(s): CABT 1455) 5C/2/3/0

CABT 1470 CAD/CNC

In this course students will learn to use CAD software to design objects. Students will also learn to apply tool paths, choose tooling, save files, and CNC router operations. 2CR 0/2/0

CABT 1475 Industrial Machining Methods

This course will reinforce proper machine operation and safety on woodworking machinery. Advanced woodworking machinery will be demonstrated, along with safety tests on these machines. Machine maintenance and tooling is covered. A series of projects will give the students hands-on experience. 4C/1/3/0

CABT 2450 Surface Applications

This course introduces students to laminates/veneers, the tools used for laminating, and laminate counter tops. Students will learn to measure, order material, layout, and fabricate laminate counter tops. Solid surface, stone products, and other types of counter tops are also covered. Various projects will give the students hands-on experience. 4C/1/3/0

CABT 2455 Casework & Millwork

This course introduces the students to frameless cabinetry which is also known as European cabinetry, or 32mm cabinetry. Hardware used in frameless cabinets will be covered and then students will learn design, layout, and build frameless cabinets using the boring machines and edgebanders. Commercial fixtures used in retail will also be covered in this course. (Co-Requisite(s): CABT 1475) 5C/1/4/0

CABT 2515 CNC Cabinet Design

In this course students will learn to lay out and design cabinets using cabinet design software. Students will learn to edit or modify within program to meet the given cabinet specifications and then convert to CAM files to be cut out on a CNC router. 3C/2/1/0

CABT 2690 Capstone Project/Open Lab

This course is to be taken the last semester the student is registered for Cabinetmaking. In this course students will use all that they have learned in previous courses to design a project, estimate materials and costs, order the materials, and then fabricate the project. 2C/0/2/0

CABT 2695 Internship

Students will go to work in one of our partnering wood industry shops to experience and learn in an actual shop environment. 2C/0/2/0

CABT 2700 Cabinetmaking - Open Lab

This course is for students with prior experience with woodworking terminology and shop safety; students wanting to upgrade their skills and knowledge to help them in the cabinetmaking industry. The student must be able to demonstrate the use of hand tools and portable power equipment. The student must meet with the instructor to see whether the student has the correct criteria in the cabinetmaking area. New students must meet with the instructor prior to registering for the class. Variable credits 1-2

CABT 2790 Cabinetmaking Special Projects

This course is designed to create customized projects for students as needed on an individual basis. Variable credits 1-4

Carpentry

CARP 1410 Project Estimating

Review basic arithmetic, algebra and geometry as it relates to carpentry. Students will learn construction terminology and estimate building costs. 3C/3/0/0

CARP 1420 Construction Blueprint Reading

Covers reading and interpreting blueprints used in the construction industry. Lines, abbreviations, symbols, parts of the blueprints, specifications and isometric drawings will be included in this class. 2C/2/0/0

CARP 1430 Introduction to Carpentry and Hand Tools

Learn to make drawings and sketches used in construction and learn to use basic carpentry hand tools. (Prerequisite(s): Concurrent enrollment in CARP 1420) 3C/1/2/0

CARP 1510 Intermediate Carpentry

Safety, job site working conditions and trade requirements, construction materials, building codes and residential construction concepts are included in this class. 5C/4/1/0

CARP 1521 Building Technology

Covers practice on the safe use of portable power tools and stationary shop equipment. Students gain familiarity with materials used in the construction industry and procedures used in the erection of residential and light commercial buildings. (Prerequisite(s): Concurrent enrollment in CARP 1510) 5C/0/5/0

CARP 1522 Power Tool and Shop Procedures

Continuation of CARP 1521. Includes practice on the safe use of portable power tools and stationary shop equipment. Students gain familiarity with materials used in the construction industry and procedures used in the erection of residential and light commercial buildings. (Prerequisite(s): Concurrent enrollment in CARP 1510) 5C/3/2/0

CARP 2410 Advanced Carpentry

Covers the methods and features of the instruments used by carpenters in laying out buildings. Cabinet installation, job seeking, soil types and excavations, properties of concrete and equipment and procedures used in the erection of commercial construction projects are included in this class. (Prerequisite(s): CARP 1510, CARP 1521, CARP 1522) 6C/4/2/0

CARP 2421 Fieldwork and Carpentry Procedures

Provides hands-on experience with the optic and electronic instruments used in laying out buildings. Erect scaffold systems and concrete forming systems used on commercial building projects. (Prerequisite(s): Concurrent enrollment in CARP 2410) 5C/1/4/0

CARP 2422 Carpentry Concrete Technology and Installation

Continuation of CARP 2421. Get hands-on experience with the optic and electronic instruments used in laying out buildings. Erect scaffold systems and concrete forming systems used on commercial building projects. (Prerequisite(s): Concurrent enrollment in CARP 2410) 5C/1/4/0

CARP 2495 Special Topics in Carpentry

This course is designed to present additional or unique material and learning experiences within a specified discipline. The course will be based on student need, flexibility, and may be designed to meet various program and pre-major course requirements. Please see a current Course Schedule for complete course details. Variable credits 1-6

Center for Manufacturing and Applied Engineering

(The following courses are restricted to the 360o Program
– see an advisor for more information)

CMAE 1502 Technical Mathematics

This is an introductory technical math course. The course is designed for students who have basic math skills and for those who need a review of basic technical math concepts. The primary goals of this course are to help individuals acquire a solid foundation in the basic skills of math/shop algebra and geometry. This course will show how these skills can model and solve authentic real-world problems. This is a blended on-line course utilizing Tooling “U”, D2L Brightspace. 3C/3/0/0

CMAE 1506 Introduction to Computers

This e360 course provides essential, hands-on coverage of Microsoft Office suite which includes: Getting Started with Microsoft Office, new features and user interface; Word core skills and new features such as Design Themes and Live Preview; Excel key concepts and skills, table styles and conditional formatting; Access database creation, working in Layout view and Navigation Pane; PowerPoint fundamentals of creating well-designed presentations; Email/Netmail, D2L Brightspace, Smart Thinking, Computer Security and E-folio building. This course requires on-site lab attendance. 2C/1/1/0

CMAE 1510 Print Reading

This course will orient the student in the basic skills and abilities required for understanding prints utilized in a manufacturing/industrial environment. Emphasis will be on interpretation of Geometric Dimensioning and Tolerancing symbols/principles; Alphabet of lines; Multi-view drawing (including Orthographic Projection, Isometric Views and Perspective Drawing); Title blocks; Revision systems; Identification of general/local notes; Dimensions and tolerances; Basic principles of math/geometry in relation to mechanical print reading; Interpretation of basic weld symbols; Techniques of basic shop sketching and interpretation of three-dimensional drawings, will be also discussed. Each student will have the opportunity to apply the knowledge acquired through a variety of in-class activities and external assignments. 2C/2/0/0

CMAE 1514 Safety Awareness

This course is designed to align with the Manufacturing Skill Standards Council's (MSSC) assessment and certification system for Safety. The course curriculum is based upon federally-endorsed national standards for production workers. This course will introduce OSHA standards relating to personal protective equipment, HAZMAT, tool safety, confined spaces, and others. 2C/2/0/0

CMAE 1518 Manufacturing Processes and Production

This course is designed to align with the Manufacturing Skill Standards Councils (MSSC) assessment and certification system for Manufacturing Processes. The course curriculum is based upon federally-endorsed national standards for production workers. This

course emphasizes Just-In-Time (JIT) manufacturing principles, basic supply chain management, communication skills, and customer service. 2C/2/0/0

CMAE 1522 Quality Practices

This course is designed to align with the Manufacturing Skill Standards Council's (MSSC) assessment and certification system for Quality Practices. The course curriculum is based upon federally-endorsed national standards for production workers. Emphasis is placed on Continuous Improvement concepts and how they relate to a quality management system. Students will be introduced to a quality management system and its components. These include corrective actions, preventative actions, control of documents, control of quality records, internal auditing of processes, and control of nonconforming product. 2C/2/0/0

CMAE 1526 Maintenance Awareness

This course is designed to align with the Manufacturing Skill Standards Councils (MSSC) assessment and certification system for Maintenance Awareness. The course curriculum is based upon federally-endorsed national standards for production workers. The Maintenance Awareness course introduces the concepts of Total Productive Maintenance and preventative maintenance. Students are introduced to lubrication, electricity, hydraulics, pneumatics, and power transmission systems. 2C/2/0/0

CMAE 1528 Career Success Skills

This is an introductory career success skills course. The primary goals of this course are to help individuals acquire a solid foundation in the basic skills for a successful career. This course will identify the skills important to businesses and help the student assess his/her level of skill. The course will provide suggestions for how the student can improve his/her level of skill. This is an on-line course utilizing D2L Brightspace and Screencast. 1C/1/0/0

CMAE 1530 Machining Math

This is a math course designed for students in a machine shop environment. The primary goals of this course are to help individuals acquire a solid foundation in the basic skills of math that relate directly to the machine shop and industrial manufacturing. This course will show how these skills can model and solve authentic real-world problems. This is a blended on-line course utilizing Tooling “U”, D2L Brightspace and proctored unit exams. (Prerequisite(s): CMAE 1502) 2C/2/0/0

CMAE 1532 Machine Tool Print Reading

This course covers the principles of mechanical print reading. Course includes sketching, lines, dimensioning and tolerancing, and single/multi-view drawings. (Prerequisite(s): CMAE 1510 Print Reading) 2C/2/0/0

CMAE 1534 Machine Tool Technology Theory

This course will address the machining theory related to the safety and operation of basic machine tools including: drill press, vertical milling machine, engine lathe, precision and non-precision grinders, saws and precision measuring equipment. This course uses Tooling U and D2L Brightspace. (Prerequisite(s): CMAE 1530 Machining Math and CMAE 1532 Machine Tool Print Reading) 2C/2/0/0

CMAE 1536 Machine Tool Technology 1

This course will address the operations of a drill press, tool grinder, vertical milling machine, engine lathe, and saws. Machine safety, machine component identification, as well as turning, milling, sawing, bench work, drilling and single-point tool grinding projects are also included in the components listed above. The student will also learn the care and use of inspections and layout tools. (Co-Requirement(s): CMAE 1534 Machine Tool Technology Theory) 2C/0/2/0

CMAE 1538 Machine Tool Technology 2

This course will address the advanced operations of a drill press, vertical milling machine, engine lathe, surface grinder and saws. Machine safety, machine component identification, as well as turning, milling, sawing, drilling and surface grinding projects are also included in the components listed above. The student will also learn the care and use of high precision measuring equipment. (Prerequisite(s): CMAE 1536 Machine Tool Technology 1) 2C/0/2/0

CMAE 1540 Introduction to CNC Machining

This course is an introduction to CNC machining. The focus will center on CNC machining centers and will include the history of CNC machining, G & M codes, programming, set-up and operating procedures. This is an online course utilizing Tooling U and D2L Brightspace. Online Text: Mill CNC Programming. (Prerequisite(s): CMAE 1536 Machine Tool Technology 1) 3C/3/0/0

CMAE 1542 Geometric Dimensioning and Tolerancing

Students will engage in learning how to read prints with Geometric Dimensioning and Tolerancing applications. Each of the geometric controls will be examined so the student may determine the allowable variation in form and size between part features. The Y14.5 M standard will be part of the overall instruction. Using precision equipment most of the geometric controls will be inspected to print specifications. (Prerequisite(s): CMAE 1532) 2C/2/0/0

CMAE 1550 DC Power

This course covers the basic principles in DC electric circuits including series, parallel and complex circuit analysis, Ohm's Law, meters, conductors, insulators, resistors, batteries, and magnetism. The use and understanding of test equipment for circuit analysis is stressed. 3C/3/0/0

CMAE 1552 AC Power

This course covers investigation of alternating current and its behavior in resistive, inductive and reactive series, parallel, and series/parallel circuits; use of test instrumentation; and electromagnetic induction. 3C/3/0/0

CMAE 1554 Digital Electronics

This is a first course in Digital Electronics. The primary goals of this course are to help individuals acquire a fundamental knowledge of digital electronics, Boolean algebra, digital devices, analog to digital conversion and digital to analog conversion, and how to apply their knowledge and skills through problem solving, simulation and practical projects. This course requires on-site lab attendance. 3C/1/2/0

CMAE 1556 Analog Circuits

This course covers diodes, power supplies, transistor operation, biasing, and specifications along with amplifier configuration and applications. It also covers operational amplifier operation, applications, and related circuitry. Troubleshooting, design, and circuit analysis are emphasized. This course requires on-site lab attendance. 3C/2/1/0

CMAE 1558 Motor Controls

This course introduces the learner to motor control components and provides them with a basic knowledge of control circuitry. The learner will build on his/her experiences from Basic Electricity by designing, building, and troubleshooting more complex circuits. Devices such as contractors, motor-starters, relays, timers, mechanical, and proximity switches are used. Electronic motor controls and programmable devices such as variable frequency drives are introduced and in this course. (Prerequisite(s): CMAE 1550 and 1552) 3C/3/0/0

CMAE 1560 Interpreting Symbols

The welding profession requires a good working knowledge of the fundamental component of welding prints that make up structures

in the welding industry. To accurately layout and fabricate parts, the welder will need basic knowledge of print lines, dimensions, notes, and welding symbols. The students will breakdown welding prints to develop the skills necessary to fabricate individual component parts that will make-up welded structures. Written and fundamental tests will be administered in accordance with the American Welding Society (AWS) and the appropriate correlating code books. 2C/2/0/0

CMAE 1562 OxyFuel Welding

This course covers the use of oxy-fuel equipment while welding, cutting, brazing, and using the Plasma Arc Cutting (PAC) and Air Carbon Arc Cutting (CAC-A) processes. There will also be an introduction into laser cutting equipment. A very important part of this course will be discussing safety as it relates to the thermal welding and cutting equipment. Time will be spent in the lab developing skills using the thermal welding and cutting processes. Welds will be made in the flat, horizontal, vertical, and overhead positions. Cuts will be made in the flat and horizontal positions. Written and Fundamental tests will be done in accordance with the American Welding Society (AWS) codes and standards. This course requires on-site lab attendance. 3C/1/2/0

CMAE 1564 Shielded Metal Arc Welding (SMAW)

Students will study the safety concerns connected with the Shielded Metal Arc Welding (SMAW) process, along with an introduction into the types of power sources used for arc welding, process applications, electrode selections, overview of weld types, and other work-related safety conditions in the welding field. Time will be spent in the lab developing skills using the SMAW processes. Welds will be made in the flat, horizontal, vertical, and overhead positions. Written and fundamental tests will be done in accordance with the American Welding Society (AWS) codes and standards. This course requires on-site lab attendance. 3C/1/2/0

CMAE 1566 Gas Metal Arc Welding (GMAW) / Flux Cored Arc Welding (FCAW)

Students will study the safety concerns connected with the Gas Metal Arc Welding (GMAW) and Flux Cord Arc Weld (FCAW). The GMAW process will be discussed in depth in relationship to the different type of modes of transfer available, shielding gases, and the different types of materials that can be welded. The FCAW process is similar in the type of equipment used for mode of transfer. The differences in the electrode types of gas-shielded wires and self-shielded wires will be discussed along with the types of shielding gases that are used. There will be discussions on the importance of how the welding process intersects with the arc welding symbols and codes. Along with this, we will also do a review of procedures used in the visual inspections of welds. Time will be spent in the lab developing skills using the GMAW and FCAW processes. Welds will be made in the flat, horizontal, vertical, and overhead positions. Written and Fundamental tests will be done in accordance with the American Welding Society (AWS) codes and standards. This course requires on-site lab attendance. (Prerequisite(s): CMAE 1564) 3C/1/2/0

CMAE 1568 Gas Tungsten Arc Welding (GTAW)

This course covers the safety hazards and applications for Gas Tungsten Arc Welding (GTAW) in the welding industry. Material covered in the classroom will be power sources, setup, types of current, current selection, shielding gases and torch types. Various procedures will be discussed for welding different metals (Aluminum, Stainless Steel, and Mild Steel) and potential problems that may be encountered. Applications for the process in different industries, and the use of back purging and its application will also be discussed. Welds will be made in the flat, horizontal, vertical and overhead positions. Written and Fundamental tests will be done in accordance with the American Welding Society (AWS) codes and standards. This course requires on-site lab attendance. (Prerequisite(s): CMAE 1564, 1566, 1570) 3C/1/2/0

CMAE 1570 Metallurgy

This course covers the study of metals and how the effects of welding

and heat treatments affect them. Terminology dealing with metallurgy will be an important part of the course. Physical and mechanical properties of ferrous and nonferrous metals will be covered along with the classifications of the different types of metals. By understanding the mechanical properties of metals, you will gain an understanding of the range of usefulness of the materials in the metal working community. Written tests will be done in accordance with the American Welding Society (AWS) codes and standards. 1C/1/0/0

Chemistry

CHEM 1700 Chemistry Concepts

This laboratory science course covers the basic concepts of chemistry. Topics include measurements and calculations used in chemistry; the general properties of chemicals; physical characteristics of matter, atoms and elements; basics of chemical bonding; chemical equations and their uses; gases, liquids and solids; solutions; and acids and bases. The course relates chemistry concepts to applications in everyday life. The course is intended for students who have not had a high school chemistry course. (Prerequisite(s): MATH 0910 Introductory Algebra with a grade of "C" or better, or appropriate assessment score) (MnTC: Goal 3) 4C/3/1/0

CHEM 1711 Principles of Chemistry 1

This course uses the scientific method to study matter; what matter is comprised of and how matter changes. Basic chemical theory and applications are covered with an emphasis on the principles and theories of atomic and molecular structure; periodic properties of elements; thermochemistry, reaction stoichiometry; behavior of gases, liquids and solids; molecular and ionic structure and bonding; energy sources and environmental issues related to energy use. The lab component includes the application of chemical concepts through observation, data collection, quantitative measurement and problem analysis. High School chemistry is recommended. (Prerequisite(s): MATH 0920 Intermediate Algebra or CHEM 1700 Chemistry Concepts with a grade of "C" or better, or appropriate assessment score) (MnTC: Goal 3) 4C/3/1/0

CHEM 1712 Principles of Chemistry 2

This course is a continuation of CHEM 1711 Principles of Chemistry 1 with an emphasis on chemical kinetics; radioactive decay; chemical equilibrium; solutions; acids and bases; solubility; second law of thermodynamics; electrochemistry and corrosion; descriptive chemistry of the elements; coordination chemistry; biochemistry; and applications of chemical principles to environmental problems. The lab component of this course provides students with the opportunity to apply chemical concepts through observation, data collection, quantitative measurement and problem analysis. (Prerequisite(s): CHEM 1711 with a grade of "C" or better) (MnTC: Goal 3) 4C/3/1/0

CHEM 2700 Organic Chemistry Survey

This course is a one semester survey course of topics in organic chemistry. This course is designed to give a basic understanding of the role that organic compounds play in nature as well as their industrial applications. Topics include an overview of covalent bonding, nomenclature, reactions, and stereochemistry. A variety of different organic functional groups will be studied including alkanes, aromatics, halides, alcohols, aldehydes, ketones, and carboxylic acids. The laboratory activities include an introduction to laboratory techniques used in chemical synthesis, and the use of chromatography and spectroscopy in the analysis of organic compounds. (Prerequisite(s): CHEM 1711 with a grade of "C" or better) (MnTC: Goal 3) 4C/3/1/0

CHEM 2720 Organic Chemistry 1

This course is the first semester of a two-semester sequence in organic chemistry. Topics include an overview of covalent bonding, acid-base chemistry, and reaction energetics. The course also covers nomenclature, stereochemistry, organic molecular structures,

substitution and elimination reactions and reactions alkanes, alkenes, alkynes, and alcohols. The laboratory activities include an introduction to laboratory techniques used in organic chemical synthesis, and the use of chromatography and spectroscopy in the analysis of organic compounds. Three hours of lab per week are required. (Prerequisite(s): CHEM 1712 with a grade of "C" or better) (MnTC: Goal 3) 5C/4/1/0

CHEM 2721 Organic Chemistry 2

This course is a continuation of CHEM 2720 Organic Chemistry 1. Topics include amines, ketones, aldehydes, carboxylic acids, and their derivatives. Reaction mechanisms studied include electrophilic aromatic substitution, nucleophilic aromatic substitution, nucleophilic addition and substitution at carbonyl groups, and reactions at the alpha carbon of carbonyl compounds. The course also includes application of organic chemistry related to polymers, natural products, and biochemistry. The laboratory activities cover reactions, synthesis, and the chemical and instrumental identification of organic compounds. Three hours of lab per week are required. (Prerequisite(s): CHEM 2720 with a grade of "C" or better) (MnTC: Goal 3) 5C/4/1/0

CHEM 2730 Instrumental Analysis

This course introduces the principles of analytical methods and instrumentation. The theories and applications of various chemical and biochemical methods of analyses will be studied. Instrumentation methods including chromatography, spectrophotometry, microscopy, and others will be applied in laboratory to a variety of chemical and biological systems. Mathematical calculations, statistical analysis of data, and quantitative chemical analysis will also be incorporated. Students will also be introduced to standards important to quality control in regulatory environments, using documentation procedures and validation principles according to regulatory standards. (Prerequisite(s): CHEM 1711 with a grade of "C" or better) (MnTC: Goal 3) 4C/2/2/0

CHEM 2790 Science Technician Laboratory Research Project

This course provides students with an opportunity to design and carry out a science research project under the supervision of a faculty advisor. The research project will be prepared using literature review, problem identification, procedural documentation, data collection, data analysis, findings, conclusions, and recommendations. Evaluation will be carried out by a faculty member and an expert in the field. The course will also provide an opportunity for field study in an approved internship setting (Prerequisite(s): Instructor approval) (MnTC: Goal 3) Variable credits 1-4

CHEM 2791 Cleanroom Lab Research Project

This course provides students with an opportunity to design and carry out a research project under the supervision of a faculty advisor utilizing the cleanroom facilities. The research project will be prepared using literature review, problem identification, procedural documentation, data collection, data analysis, findings, conclusions, and recommendations for future research. The course will also provide an opportunity for field study in an approved internship setting. Evaluation will be carried out by a faculty member and an expert in the field. (Prerequisite(s): Instructor approval) (MnTC: Goal 3) Variable credits 1-4

CHEM 2795 Special Topics in Chemistry

This course is designed to present additional or unique material and learning experiences within a specified discipline. The course will be based on student need, flexibility, and may be designed to meet various transfer and pre-major course requirements. Please see a current Course Schedule for complete course details. (MnTC: Goal 3) Variable credits 1-6

Child Development

CDEV 1200 Introduction to Early Childhood Education

This course provides an overview of the early childhood field, including philosophies, missions, and regulations. It examines the roles and responsibilities of professionals in a variety of career settings. Examines positive communication and relationships with families. 3C/3/0/0

CDEV 1210 Child Growth and Development

Examines the major developmental milestones for children, both typical and atypical, from conception through adolescence in the areas of physical, psychosocial, and cognitive development. Emphasizes interactions between maturational processes and environmental factors. While studying developmental theory and investigative research methods, students will observe children and analyze characteristics of development at various stages. 3C/2/1/0

CDEV 1220 Health, Safety and Nutrition

An introduction to the regulations, standards, policies, and procedures, prevention techniques, and early childhood curriculum related to health, safety, and nutrition. The key components that ensure physical health, mental health, and safety for both children and staff will be identified, as well as the importance of collaboration with families and health professionals. A focus will be on integrating the concepts into everyday planning and program development. 3C/2/1/0

CDEV 1230 Guiding Children's Behavior

Examines positive strategies to guide children's behavior in the early childhood setting. Examines ways to establish supportive relationships with children and guide them, in order to enhance learning, development, and well-being. 3C/3/0/0

CDEV 1240 Learning Environment and Curriculum

Presents an overview of knowledge and skills related to providing appropriate curriculum and environments for young children. Examines the role of the teacher in providing learning experiences to meet each child's needs, capabilities, and interests, and ways to implement the principles of developmentally appropriate practices. Will provide an overview of content areas including (but not limited to): Language and literacy, social and emotional learning, sensory learning, art and creativity, math and science. 4C/3/1/0

CDEV 1610 Observation and Assessment

This course focuses on the appropriate use of assessment and observation strategies to document development, growth, play and learning to join with families and professionals in promoting children's success. Recording strategies, rating systems, multiple assessment tools and portfolios are explored. There will be a focus on increasing objectivity in observing and interpreting children's behavior, observing developmental characteristics and increasing the awareness of normal patterns of behavior. (Prerequisite(s): Completion of all certificate level coursework or instructor approval) 3C/3/0/0

CDEV 1640 Curriculum Planning

Provides an advanced level of curriculum planning. Emphasis is on organizing, implementing, and evaluating developmentally appropriate curricula. (Prerequisite(s): Completion of certificate level coursework and instructor approval) 3C/3/0/0

CDEV 1910 Practicum 1

Students demonstrate early childhood teaching competencies under guided supervision to make connections between theory and practice and developing professional behaviors. Students apply comprehensive understanding of children and families; developmentally appropriate, child-centered, play-oriented approaches to teaching and learning, and knowledge of curriculum content areas. They design, implement, and evaluate experiences that promote positive development and learning for all young children. (Prerequisite(s) Completion of all other Diploma level courses and instructor approval) 3C/0/0/3

CDEV 2320 Children with Differing Abilities

Examines the child with differing abilities in an early childhood setting. Students will integrate strategies that support diversity and anti-bias perspectives, provide inclusive programs for young children, apply legal and ethical requirements including, but not limited to ADA and IDEA, differentiate between typical and exceptional development, analyze the differing abilities of children with physical, cognitive, health/medical, communication, and/or behavioral/emotional disorders, work collaboratively with community and professional resources, utilize an individual education plan, adapt curriculum to meet the needs of children with developmental differences, cultivate partnerships with families who have children with developmental differences (Prerequisite(s): Completion of all certificate level coursework or instructor approval) 3C/2/1/0

CDEV 2530 Children with Challenging Behaviors

Helps students understand children's behavior problems and identify intervention strategies to prevent and resolve problem behavior, use behavior modification effectively and design behavior plans. 3C3/0/0

CDEV 2550 Math, Science and Technology for Young Children

Provides an overview of cognitive development and math and science learning experiences in home and center-based settings. Students integrate knowledge of child development, learning environments and teaching methods to promote curiosity, attention, perception, memory, problem solving, and logical thinking, etc. 3C/2/1/0

CDEV 2560 Language & Literature Learning Experiences

Provides an overview of language learning experiences in early childhood settings and a detailed study of literature/literacy experiences. Students will integrate knowledge of children's language and literacy development, learning environments and teaching strategies to select, plan, present, and evaluate literature experiences to children of different abilities and diverse backgrounds. 3C/2/1/0

CDEV 2570 Working with Diverse Children and Families

Examines how to work with many types of families. Investigates the importance of the family/school partnership, study methods of effectively communicating with families, and identify community organizations and networks that support families. Various classroom strategies will be explored emphasizing culturally and linguistically appropriate anti-bias approaches supporting all children in becoming competent members of a diverse society. 3C/3/0/0

CDEV 2597 Special Topics

Intent of this course is to allow flexibility in providing learning experiences to meet a special need of the student, the major program and the College. (Prerequisite(s): Instructor approval) Variable credits 1–4

CDEV 2599 Practicum 1: Special Settings/American Sign Language

Provides an opportunity to apply knowledge and skill in an actual child development setting. Students will observe and assess children's behavior; facilitate free play; implement adult-directed learning experiences; and maintain professional relationships. (Prerequisite(s): Completion of all CDEV ASL courses and instructor approval) 2C/0/0/2

CDEV 2600 Organizational Leadership and Management

The student will discuss personal and professional reasons for becoming a teacher, ways to advocate in this profession and will develop a plan for continuous education and professional development. The student will join a professional organization and attend a professional conference. Students will improve skills in working with others by learning strategies for team building, coping with stress, and problem-solving. Students will study professional ethics and procedures for evaluating staff. (Prerequisite(s): Completion of certificate level coursework) 2C/2/0/0

CDEV 2620 Practicum 2

Provides an opportunity to apply knowledge and skill in early childhood settings. Students implement a variety of learning experiences that are developmentally appropriate for and culturally sensitive to two different age groups and program settings. (Prerequisite(s): Successful completion of all other required AAS coursework and Instructor approval) 4C/0/0/4

Chinese Language

CHIN 1710 Beginning Chinese 1

This course introduces Mandarin Chinese language based on the knowledge of basic skills and strategies in listening, speaking, reading and writing in a general Mandarin speaking environment. Learners will acquire the language through a theme-based and function-based approach, but also by focusing on grammar whenever necessary. China's culture and history are also important components of the course. At the end of the term, students are expected to be able to communicate some basic personal information, both oral and written. They will read and write simplified Chinese characters and learn some key components of Chinese culture and general knowledge of Chinese history. The course will also prepare students for further studies in Chinese. This course consists of five hours per week of instruction and in-class discussion in addition to homework, tape assignments, and on-line practice. (Prerequisite(s): READ 0722 Reading 2 with a grade of "C" or better or appropriate assessment score) (MnTC: Goal 8) 5C/4/1/0

CHIN 1720 Beginning Chinese 2

As the second part of the Accelerated Modern Chinese course series, this course is designed for heritage speakers of Chinese or those who have completed CHIN 1710 at Saint Paul College. The purpose of this course is to help students improve their ability in listening, speaking, reading, and writing Chinese. It particularly aims to help students develop more sophisticated vocabulary and enhance reading and writing ability in Chinese. As with CHIN 1710, the course consists of five hours per week of instruction and in-class discussion, homework, tape assignments and online practice. (Prerequisite(s): CHIN 1710 with a grade of "C" or better or instructor approval) (MnTC: Goal 8) 5C/4/1/0

CHIN 1790 Special Topics in Chinese

This course is designed to present additional or unique material and learning experiences within a specified discipline. The course will be based on student need, flexibility, and may be designed to meet various transfer and pre-major course requirements. Please see a current Course Schedule for complete course details. (MnTC: Goal 8) Variable credits 1-6

CNC Toolmaking

CNCT 1410 Introduction to Manufacturing Processes

This course covers a general orientation, an overview of careers, shop safety, measurement, precision tools, band saw theory, lathe theory, drills and vertical milling machines. This course will include additional theory and online assignments. (Co-requisites: CNCT 1430 Materials Process I and CNCT 1431 Materials Process 2) 4C/4/0/0

CNCT 1420 Engineering Drawing

This introductory course covers view orientation, section views, surface finish, dimensioning, part tolerance, and machining symbols. This course will include additional theory and online assignments. (Co-requisite: CNCT 2520 CAD) 4C/4/0/0

CNCT 1430 Material Processes 1

This introductory lab covers shop safety, bench work, drill presses, lathe operations, and vertical milling. (Co-requisites: CNCT 1410 Introduction to Manufacturing Processes and CNCT 1431 Materials Process 2). 4C/1/3/0

CNCT 1431 Material Processes 2

This intermediate lab course covers surface grinding, bench work, band saws, lathe operations, drill presses and vertical milling. (Co-requisites: CNCT 1410 Introduction to Manufacturing Processes and CNCT 1430 Materials Process I). 4C/0/4/0

CNCT 1710 Shop Calculations

The subject matter of this course progresses from the arithmetical operations through measurement systems, basic algebra for shop formula solving skills, practical geometry with shop examples, and applications and trigonometry, emphasizing its valuable use in the shop and in the trade. (Prerequisite(s): CNCT 1431 with a grade of "C" or better and Co-requisites: CNCT 1720 Geometric Dimensioning and CNCT 1744 Metrology) 2C/2/0/0

CNCT 1720 Geometric Dimensioning

This course covers the principles, application, and interpretation of geometric dimensioning and tolerance as per ASME-Y14.5M 1994 Standards. (Prerequisite(s): CNCT 1431 with a grade of "C" or better and Co-requisites: CNCT 1710 Shop Calculations and CNCT 1744 Metrology) 2C/2/0/0

CNCT 1730 CNC 1

This introductory course covers view orientation, section views, surface finish, dimensioning, part tolerance, and machining symbols. This course will include additional theory and online assignments. (Co-requisite(s): CNCT 1731 CNC 2 and CNCT 2540 Computer Aided Manufacturing) 4C/2/2/0.

CNCT 1731 CNC 2

This course covers the setup and operation of CNC machine tools. Also includes advanced NC/CNC programming and operation on machining centers. (Co-requisite(s): CNCT 1730 CNC 1 and CNCT 2540 Computer Aided Manufacturing). 4C/2/2/0

CNCT 1744 Metrology

This course covers the identification, use and care of precision measuring devices used in manufacturing. Students will learn through lecture and lab how to perform accurate measurements in a repeatable manner. Standard hand devices as well as manual and programmable coordinate measuring machines, vision systems, and optical comparators will be addressed. Theories in quality control principles will be introduced. (Co-requisite(s): CNCT 1710 Shop Calculations and CNCT 1720 Geometric Dimensioning). 4C/3/1/0

CNCT 2412 Tool Design

This course covers analysis and design fundamentals required to design production tooling. The course will center around modern mold and die design principles. Content includes types of molds, plastic molding characteristics, metal alloy casting, die types, clearance, tonnage, steel types, steel classification systems, and basics of metallurgy. Course is web-enhanced with assignments, quizzes and exams completed online. (Prerequisite(s): CNCT 1731 and CNCT 1422 with a grade of "C" or better) (Co-requisite (s): CNCT 2421 Mechanical Systems/EMS, CNCT 2441 CNC Applications). 4C/3/1/0

CNCT 2421 Mechanical Systems/EDM

The focus of this hybrid course will be on manufacturing design, production processes, and Electrical Discharge Machining. Also included will be production tool design projects, related theory in quality, lean manufacturing, abrasives, mechanical systems, inspection procedures, welding and CNC controls. (Prerequisite(s): CNCT 1740 with a grade of "C" or better) (Co-requisites: CNCT 2412 Tool Design, CNC 2440 CNC Applications). 4C/2/2/0

CNCT 2431 Moldmaking/Plastic Technology

This introductory, web enhanced course covers the design and construction principles of basic plastic injection molds. Manual mills, lathes, surface grinders, drill presses, as well as 2 and 3 Axis CNC programming and machining, and CAD and CAM are used in a laboratory setting to

produce plastic injection molds. (Prerequisite(s): CNCT 1731 and CNCT 1740 and CNCT 1422 or CNCT 2520 with a grade of "C" or better) (Co-requisite(s): CNCT 2530 CNC Lathe). 4C/2/2/0

CNCT 2441 CNC Applications

This course covers product development fundamentals including design and research, cost estimating and manufacturing of a metal stamped product, CNC mill and lathe machined parts, and wire and sink EDM machined components. The course will include basic machining processes such as milling, turning, precision surface grinding, form grinding, CNC milling and turning and wire and sink EDM processes. (Prerequisite(s): CNCT 1730 CNC 1 and CNC 1731 CNCT 2 with a grade of "C" or better) (Co-requisites: CNCT 2412 Tool Design and CNCT 2421 Mechanical Systems/EDM) 4C/2/2/0

CNCT 2520 CAD

This introductory course will use SolidWorks as the CAD software of instruction and application. Basic construction of solid modeling, engineering drawings, and assemblies will be covered. (Co-requisite: CNCT 1420 Engineering Drawings). 4C/4/0/0

CNCT 2530 CNC Lathe

This course covers the programming, set-up, and operation CNC turning centers. This course will include additional theory and online assignments. This is a hybrid course. (Prerequisite(s): CNCT 1430, CNCT 1431 with a grade of "C" or better) (Co-requisite: CNCT 2431 Moldmaking/Plastic Technology). 4C/1/3/0

CNCT 2540 Computer Aided Manufacturing

This course covers computer aided manufacturing using Mastercam software. Students will learn to create geometry, toolpaths, and CNC files for a series of projects. The use of PC based CAM software to generate numerical control programs is included. (Co-requisite(s): CNCT 1730 CNC 1 and CNCT 1731 CNC 2) 4C/2/2/0

CNCT 2550 Industry Internship

This industry internship will expose the student to manufacturing, and will provide operator training and workplace safety. (Prerequisite(s): A grade of "C" or better in all program courses.) 4C/0/0/4

College & Career Planning Success Strategies

CSCR 1403 Choosing Your Career Path

This course focuses on the career planning and decision-making process. Students will acquire skills in identifying potential career areas based on personal assessments and in utilizing career decision-making and goal-setting strategies to determine a career choice. Students will utilize various career resources, such as online sites, to assist in the decision-making planning process. 1C/1/0/0

CSCR 1405 College Success Strategies and Career Resources

This course is designed to help students succeed in college and develop career-planning skills. Students will learn to study more effectively. Focused topics will include time management, study strategies, note-taking, test-taking, mnemonic devices and college resources. Students will gain knowledge of career resources and the career-planning process. 2C/2/0/0

Communications

COMM 1710 Fundamentals of Public Speaking

This course covers the basic principles of preparing, researching, and delivering informative, persuasive, impromptu, and extemporaneous speeches. Instructional methodologies instruct students on computer-mediated communication issues as well as international audience analysis and multi-cultural demands of public speaking venues. In

addition, this course will include audience analysis and suggestions for overcoming speech anxiety. Students will analyze and evaluate the arguments and rhetorical methods used in public communication. (MnTC: Goals 1 & 8) 3C/3/0/0

COMM 1720 Interpersonal Communication

This course focuses on the practical and theoretical concepts of human communications and the styles used in personal, social and professional environments. Students will also acquire skills in critical thinking, perception, listening, verbal and non-verbal expressions and conflict resolution. Students will evaluate their individual strengths and weaknesses in depth and develop techniques to improve interpersonal relations. (MnTC: Goals 1 & 7) 3C/3/0/0

COMM 1730 Intercultural Communication

This course will study the influence of cultural differences on communication from both the sender and receiver of information. The course views the human communication process as it is influenced by nationality, ethnicity, linguistic development and gender. The course will explore the ways in which culture can shape the view of "reality" held by its members and influence communication patterns and cross-cultural relationships. Specifically, the United States cultural orientations will be compared to those in other regions of the world. (MnTC: Goals 1 & 8) 3C/3/0/0

COMM 1740 Mass Media and Communications

The influence of mass media communications on today's culture is an important issue in the United States and throughout many parts of the world. Students will research the influence of mass media on society. Topics include: advertising, propaganda, ethics, First Amendment issues, the role of government, literacy requirements of a digital world, and problems and criticisms of media. (Prerequisite(s): Grade of "C" or better in READ 0721 or appropriate assessment score) (MnTC: Goals 5 & 9) 3C/3/0/0

COMM 1750 Small Group Communication

In this course students will study communication in small groups. Topics include effective group communication theory and skills; group leadership, cohesion and roles; conflict resolution and decision making; planning and conducting meetings; and parliamentary procedure. The course explores group functioning in a variety of settings, including the workplace. There is an emphasis on the practical application of the content and the practice of oral communication skills. (MnTC: Goals 1 & 9) 3C/3/0/0

COMM 1770 Family Communication

This course centers upon the human communication process from within the contextual dimensions of diverse family units. Elements of study include family patterns and functions, which drive communication, relationship development and its barriers, and family role definitions and functions. The course is designed to provide a sense of understanding of how a family communicates, and the forces which influence the family unit, from both the inside and outside of various family configurations. (MnTC: Goals 1 & 7) 3C/3/0/0

COMM 1780 Gender Communication

This course explores the many interconnected aspects of gender communication, enabling students to experience how gender, within communication and culture, creates, maintains, and changes interpersonal relationships. Communication contexts covered in the course will include family, friendships, education, the media, the workplace, and other markers of identity. (MnTC: Goals 1 & 7) 3C/3/0/0

COMM 1790 Special Topics in Communications

This course is designed to present additional or unique material and learning experiences within a specified discipline. The course will be based on student need, flexibility, and may be designed to meet various transfer and pre-major course requirements. Please see a current Course Schedule for complete course details. (MnTC: Goal 1) Variable credits 1-6

Computer Science

CSCI 1410 Computer Science and Information Systems

Designed to introduce computer information systems to students in the fields of computer science and information science. The course will cover the basic architecture and design of digital computers and the software that runs on them. Special emphasis will be placed on the technical aspects of the field of computer science and a significant amount of time will be spent developing a sound analytical understanding of the field. Topics such as machine architecture, binary arithmetic, algorithm development, data structures, file organization, database design, systems analysis, data communication and systems software will be covered. Students must have a sound preparation in mathematics through basic algebra. (Prerequisite(s): Grade of "C" or better in MATH 0910 or appropriate assessment score.) 4C/4/0/0

CSCI 1423 Computer Networking 1 - Client

This course introduces students in networking programs to workstation-based operating system design, implementation and administration. The primary components of workstation operating systems such as process management, memory management systems, file systems, security subsystems, I/O control subsystems, etc. are reviewed at the conceptual level. UNIX and Windows based operating systems are used as implementation case studies. Students are expected to become proficient with the ideas inherent in operating system design and how these ideas are implemented in both UNIX and Windows based workstation operating systems. Workstation-based peer-to-peer networking is reviewed in the context of both Windows and UNIX based networking. (Prerequisite(s): Grade of "C" or better in MATH 0910 or appropriate assessment score.) 4C/4/0/0

CSCI 1440 Networking Fundamentals

This course provides an introduction to computer networking. The material in the course follows the OSI networking model as a basis for coverage of the entire field of computer networking. Topics include the physical, data link, network, transport, session, presentation and application layers of the OSI model as they are implemented in current network technologies. Students will use a very hands-on approach learning physical networking as well as logical networking tasks. The course makes extensive use of Cisco networking hardware and software as well as Cisco learning materials. With extensive outside study and review students in this course may become prepared to become certified as Network+ level technicians. (Prerequisite(s): Grade of "C" or better in MATH 0910 or appropriate assessment score.) 4C/4/0/0

CSCI 1450 Web Fundamentals/HTML

This course provides students with a thorough grounding in the World Wide Web, a fundamental knowledge of HTML and a basic understanding of Internet technical architectures. Students learn about search engines, Web servers, scripting, protocols, ISPs and other Internet technologies. Technical architecture topics include the study of networks, Internet protocols, Internet servers, firewalls, security and general issues in conducting ecommerce. Students will design and program HTML Web pages, tutorials and publish a website project. (Prerequisite(s): Grade of "C" or better in MATH 0910 or appropriate assessment score.) 4C/4/0/0

CSCI 1470 Web Design

This course explores the principles of Web design theory and practice. Concepts related to the look and feel of the client-side of the World Wide Web are emphasized. Topics include the design of a graphical user interface, site content, organization and navigation, with emphasis on the human interface. Also included are Web "usability" issues. Color palettes, font selection and use of animation are discussed. The use of HTML layout concepts and software such as Photoshop and Dreamweaver are introduced. (Prerequisite(s): CSCI 1450) 4C/4/0/0

CSCI 1523 Introduction to Computing and Programming Concepts

This course is focused on computational problem solving. Students must engage in problem-solving tasks such as clarifying any ambiguous aspects of the problem definition, decomposing the

problem into subproblems, deciding which computer-related problem solving strategies (such as recursion) might be useful in solving the problem, constructing a solution, implementing the solution as a computer procedure, and verifying that the solution is correct (including modifying it when it is not). (Prerequisite(s): CSCI 1410) 4C/4/0/0

CSCI 1524 Introduction to Algorithms and Data Structures

This course is focused on the use of algorithms and data structures to solve problems. Students will solve various problems using appropriate software design methods and software tools. For example, students need to decide which problem solving strategies (such as divide and conquer) might be useful for a specific problem, construct a solution, design appropriate data types and algorithms, and verify the correctness of the solution. (Prerequisite(s): CSCI 1410 and CSCI 1523 and CSCI 1541) 4C/4/0/0

CSCI 1531 Objective-C Programming

This is a rigorous first course in Objective-C programming which is the primary development language for OSX and iOS devices. The course begins with C language features and quickly moves to the object-oriented extensions provided by Objective-C. Objects, classes, and messages are explored in depth. Concepts include: inheritance, polymorphism, dynamic typing, categories, protocols, and memory management. The Cocoa application framework is studied and the XCode development environment is used extensively. Previous exposure to C, C++, or Java is assumed. (Prerequisite(s): CSCI 1410) 4C/4/0/0

CSCI 1533 ANSI C Language Programming

This course is an intermediate introduction to Language C and the tools used to develop executable programs. The course reviews elementary C programming concepts at a rapid pace and continues with Language C development using simple data structures such as arrays and linked lists. This is followed by a detailed review of how memory is managed in Language C, pointers, referencing and dereferencing, C structures and abstract data types. Students should expect that all programming will be done at the command line using command line editors and Linux as the operating system. (Prerequisite(s): CSCI 1523) 2C/2/0/0

CSCI 1541 Java Programming

This course covers the syntax of the Java programming language and object-oriented programming with the Java programming language. It includes variables, primitive data types, decision structures, loops, file I/O, methods, classes arrays, text processing, wrapper classes, and inheritance. Students will learn how to develop Java applications using the command line interface. (Prerequisite(s): CSCI 1410) 4C/4/0/0

CSCI 1542 Java Programming 2

This course provides students with first-hand experience creating graphical user interface (GUI) applications using AWT, Swing, and JavaFX classes. Students will learn how to handle exceptions and create Java applets. Students will create Java applications to create connect to, and manipulate an SQL database. Students will learn Java concurrency and a multi-thread application will be created. Students will also have exposure to JUnit testing. (Prerequisite(s): CSCI 1410 and CSCI 1541) 4C/4/0/0

CSCI 1544 Enterprise Operating Systems

This course provides an integrated view of using IBM zEnterprise systems to prepare students to take the IBM System Z Mastery test. An overview for zEnterprise hardware concepts, z/OS operating system concepts, and interactive facilities, such as TSO/E, ISPF and UNIX will be presented. The roles of virtual and physical storage, LPARs, Parallel Sysplex, z/VM, and cluster technologies to provide scalability and continuous availability within zEnterprise systems are discussed. Students will be provided hands-on experiences using z/FS data sets, ISPF, SDSF, JCL, and JES3. A batch COBOL application will be edited, compiled, linked, and executed and debugged. CICS

applications, WebSphere (J2EE) applications, and WebSphere MQ services will be compared as alternatives to zEnterprise interfaces, middleware and OLTP transactional services. An overview of system programming and SMP/E, zEnterprise database management systems, clients and utilities, e.g., DB2, IMS, SPUFI, QMF, z/OS HTTP web server, VTAM, TCP/IP, and RACF (IBM Security Server) will be introduced. Access to a zEnterprise system, hands-on exercises, and online support materials are important components of this course. (Prerequisite(s): CSCI 1410 and CSCI 1423) 4C/4/0/0

CSCI 1546 COBOL Programming 1

This course provides the student with the hands-on skills to develop and debug COBOL applications in a zEnterprise system. Students will be introduced to TSO logon procedures, JCL, the ISPF, RDz, and SDSF. Fundamental COBOL coding rules, syntax, sequential batch report file processing, arithmetic verbs, conditional control structures, level 88s, data validation, utility sorting, control-break logic, and processing and searching single-level tables are presented. (Prerequisite(s): CSCI 1410 and CSCI 1423) 4C/4/0/0

CSCI 1547 COBOL Programming 2

Students will be introduced to Virtual Storage Access Method (VSAM). The structure and application of Virtual Storage Access Method (VSAM) datasets, i.e., ESDS, KSDS, and RRDS, are compared. Using the IDCAMS utility students will create and manage VSAM clusters to support basic file maintenance applications. Other COBOL topics include advanced table processing; batch ESDS, KSDS, and RRDS processing and updating, and the use of sub-programs. Additional concepts covered are structured program design considerations, the interrelationship of programs within an information system, coding for program efficiency and clarity, and the creation and use of quality program documentation. (Prerequisite(s): CSCI 1410 and CSCI 1546) 4C/4/0/0

CSCI 1550 Database Management Fundamentals

This course covers information models and systems; database query languages; object-oriented and relational database design; transaction processing; distributed databases; data modeling; normalization; and physical database design. The relational model is studied in-depth and students are expected to develop proficiencies in the design and implementation of databases using it. Students will spend a significant portion of the course studying SQL. Students are expected to become proficient in the use of SQL and the implementation database typically used for this course is MYSQL. This course is based on ACM specifications for a first course in Database Systems. (Prerequisite(s): CSCI 1410) 4C/4/0/0

CSCI 1714 Introduction to Data Science

This is an introductory course in the fundamental topics of data science: data architecture, data acquisition, data analysis and visualization, and data archiving. Practical techniques for working with large-scale data will be presented. Students will learn the use of analysis techniques to include summation of the data, using samples of data to make predictions about the larger context, and visualization techniques for presenting the results of data analysis. A significant portion of the course will focus on the migration of and analysis of the data using the R platform. (Prerequisite(s): MATH 1740 Introduction to Statistics) 4C/4/0/0

CSCI 2410 Management Information Systems

This course provides elementary concepts to the management of information systems. The course is designed to allow the student of management information systems to evaluate, design and implement information processing systems that support the business enterprise. The purpose of the course is to understand the underlying principles of information systems for different management functions from the business perspective. (Prerequisite(s): CSCI 1410 and CSCI 1550) 3C/3/0/0

CSCI 2420 Computer Security

This course is a comprehensive introduction to computer security. The course is an in-depth introduction the concept of cybercrime and security

in networks and the internet. It presents the conceptual frameworks of computer security assessment. Topics covered include denial of service attacks, malware, viruses, trojan horses, worms, encryption, industrial espionage, internet fraud, cyber terrorism and information warfare. The course makes extensive use of in class and Internet-based laboratories within which computer security scenarios are implemented and strategies for their design and operation are reviewed. Students taking this course should have a background in computer networking and a thorough understanding of client/server networking. With extensive outside study and review students in this course may become prepared to become certified as Security+ level technicians. (Prerequisite(s): CSCI 1423, CSCI 2451 and CSCI 2461) 4C/4/0/0

CSCI 2440 Client Side Programming 1

This course introduces JavaScript programming and the skills needed to create dynamic, client-side web pages. The basics of JavaScript programming are covered, including: basic scripting, control statements, functions, arrays, and objects. Students will then explore the DOM (Document Object Model), JavaScript event handling, DHTML (Dynamic HTML) and select advanced topics. Class sessions include hands-on work and lectures. This course assumes a working knowledge of HTML and a previous introduction to CSS (Cascading Style Sheets). (Prerequisite(s): CSCI 1450) 4C/4/0/0

CSCI 2442 Server Side Programming

This course is designed for students interested in developing the server-side skills needed to create dynamic, data-driven websites. This course uses the popular server-side programming language PHP to interact with SQL databases. Fundamental techniques are covered, including: connecting to a database and performing basic database operations to create, read, update, and delete data. HTML form elements are reviewed and then form processing is discussed as well as writing functions for data validation. Server-side scripting is used to generate dynamic web pages. Students will learn how to authenticate users, manage user requests, and maintain user state through sessions and cookies. (Prerequisite(s): CSCI 1450) 4C/4/0/0

CSCI 2451 Computer Networking 2 – Server

This course is designed to give the student of networking an introduction to client/server networking. Students in this course will be expected to install and configure both the server operating system and clients connecting to the server. At the completion of the course students understand the basics specifying, designing, installing, configuring and maintaining a client/server network. Microsoft Client and Server Software is utilized as the teaching platform and students are expected to become proficient in the use to this commercial platform. Specialized topics include network security, name resolution system, (DNS, DNS&WINS), network access protection (NAP), file services, print services, Active Directory service, etc. A significant amount of time in the course is dedicated to laboratory exercises and hands-on experience. With extensive outside study and review successful students in this course may become prepared to become certified as Microsoft Systems Administrator. (Prerequisite(s): CSCI 1410 and CSCI 1423) 4C/4/0/0

CSCI 2452 Cloud Computing

This course introduces software and technologies used to create and manage cloud computers and access to them. Both public cloud computing services such as Amazon Web Services and private cloud computers will be reviewed. Students will work directly with servers and install and configure cloud systems during the course. This course is conducted in a hands-on manner and class sessions typically will be dedicated to hands-on exercise. (Prerequisite(s): CSCI 2451 and CSCI 2461) 4C/4/0/0

CSCI 2453 Computer Virtualization

This course introduces software and technologies used to create virtual computers. Proprietary virtualization software such as VMWare and Microsoft Virtualization are covered as well as open source projects such as Xen and virtualbox. Students will work directly with servers and install and configure each of the virtualization systems during the

course. This course is conducted in a hands-on manner and class sessions typically will be dedicated to hands-on exercises. (Prerequisite(s): CSCI 2451 and CSCI 2461) 4C/4/0/0

CSCI 2460 Discrete Structures of Computer Science

This course addresses the foundations of discrete mathematics with application of computer science. Sets, sequences, functions, big-O, propositional/predicate logic, proof methods, counting methods, recursion/recurrences, relations, trees/ graph fundamentals are covered in detail. Credit will not be awarded for both MATH 2460 and CSCI 2460. (Prerequisite(s): CSCI 1410 and MATH 1730 or higher) 4C/4/0/0

CSCI 2461 Computer Networking 3 – Linux

This course provides an in-depth study of Linux based operating systems administration and networking. The installation configuration and management of Linux-based servers is covered in-depth. The course also covers the configuration of Linux-based operating systems in a network environment. Students will spend a significant amount of the classroom meeting time conducting hands-on laboratory exercises. With extensive outside study and review students in this course may become prepared to become certified as Linux systems administrators. (Prerequisite(s): CSCI 1410 and CSCI 1423) 4C/4/0/0

CSCI 2463 XML Programming

This course is designed to give the student both the theoretical foundation and hands-on skills required to begin using XML (eXtensible Markup Language). It begins by examining what XML is and what it can be used for. Early topics include elements and attributes, the use of namespaces, defining valid XML documents and the use of DTDs and Schemata to constrain XML, particularly as used in B2B (business-to-business) applications. Students learn about the DOM (Document Object Model), an object-oriented API for working with XML. XSLT (eXtensible Stylesheet Language for Transformations), Templates and Xpath are also covered. Advanced topics include XML and databases, SOAP (the Simple Object Access Protocol), the SAX (Simple API for XML) interface and others. (Prerequisite(s): CSCI 1450) 4C/4/0/0

CSCI 2465 Computer Networking 4 – Infrastructure

This course introduces networking students to the core infrastructure components of local, campus and wide area networks. The design, installation and configuration of routers, switches and other networking infrastructure devices is covered in-depth. Routing protocols and concepts are a primary focus of study in the course. The course makes extensive use of Cisco materials and equipment for routing protocols and concepts. This course assumes that the students have a background through experience, or coursework, that encompasses a fundamental understanding of networking. With extensive outside study and review, students in this course may become prepared to become certified Cisco networking technicians. (Prerequisite(s): CSCI 1410 and CSCI 1440) 4C/4/0/0

CSCI 2466 J2EE-JSP and Servlets

This is a first course in using Java technology for the development of applications deployed in a client/server environment. The course introduces the concept of a Java application server and teaches the student how to install and configure an application server for use in developing and deploying distributed Java applications. Students then are introduced to elementary servlet programming, Java server pages [JSP] development and deployment, Java standard template library [JSTL] and an introduction to Java server faces [JSF]. Students will then develop server-based applications which access data stored in a database management system via the Java database connector [JDBC]. Students in this course are expected to have a background in introductory Java programming. (Prerequisite(s): CSCI 1410 and CSCI 1450 and CSCI 1541) 4C/4/0/0

CSCI 2469 Advanced Programming Principles

The class is focused on principles that underlie the structure and analysis of programs. Students will learn different programming

styles, such as those based on functional programming, search-based programming, and concurrent programming, and will learn to program over symbolic structures. Applications will allow students to learn about modular development and language principles to support modularity. (Prerequisite(s): CSCI 1410 and CSCI 1523 and CSCI 1541) 4C/4/0/0

CSCI 2470 Enterprise Data Base Systems

This course focuses on the design, implementation, testing and integration of an IBM DB2 enterprise database with a COBOL DB2 API application. Relational Data Modeling within a business requirement context will be presented. Using a 3270-terminal emulation client, the student will be introduced to SPUFI and QMF to execute SQL batch and static SQL statements. Using DB2I, DCLGEN, ISPF, and SDSF students will code and test COBOL DB2 dynamic SQL interactive applications. The DB2 COBOL application development process, e.g., DB2 Precompile, COBOL load modules, DBRM, packages and plans will be presented. Implementation of cursors, currency, null processing, error handling, basic security and administration will be also presented. Basic SQL DDL commands will be introduced using RDz. (Prerequisite(s): CSCI CSCI 1410 and CSCI 1423 and 1546) 4C/4/0/0

CSCI 2472 Enterprise Transaction Processing (CICS)

This course focuses on the CICS Enterprise Transaction Processing System and CICS COBOL applications. CICS architecture, online resource definition (CEDA), CSD data sets, and legacy CICS resource tables are presented. Students will design, prepare (DFHMAPS) and code a BMS mapset to generate physical and symbolic maps. Using a pseudo-conversational and modular style, students will develop, prepare (DFHYITVL), and test CICS COBOL VSAM and DB2 applications using the CICS EXEC and EXEC SQL APIs. Popular CICS-supplied transactions, e.g., CESN, CESH, CEMT, CECI, and CEDA will be reviewed. Using CICS as an HTTP Server to interface with a WebSphere Application Server (WAS) and WebSphere MQ will be introduced. (Prerequisite(s): CSCI 1410 and CSCI 1423 and CSCI 1546) 4C/4/0/0

CSCI 2475 A+ Hardware/Operating System Preparation

The course provides an in-depth review of PC hardware, Operating Systems and the application software that they run. The material encompasses the body of knowledge outlined by CompTIA for their certification as an A+ computer technician. (Prerequisite(s): CSCI 1410 and CSCI 1440) 4C/4/0/0

CSCI 2480 Network Security and Penetration Prevention

This course examines the critical defensive technologies needed to secure network perimeters. Coverage includes network security threats and goals, advanced TCP/IP concepts, router security, intrusion detection, firewall design and configuration, IPSec and virtual private network (VPN) design, and wireless design and security. (Prerequisite(s): Grade of "C" or better in CSCI 2420, 2451, 2461, and 2465) 4C/4/0/0

CSCI 2482 Security Incident Handling, Response and Disaster Recovery

This course provides an overview of the process of creating and implementing policies and procedures for responding to security incidents and for disaster recovery. The student will gain skills in creating policies for responding to security incidents as well as the business continuity and disaster recovery aspects of the incident response plan. (Prerequisite(s): Grade of "C" or better in CSCI 1523, 2420, and 2465) 4C/4/0/0

CSCI 2484 Ethical Hacking and Countermeasures

This course provides an introduction to ethical hacking and security testing. Topics include tools and techniques used to detect system vulnerabilities. Students will learn how to set up defensive systems and countermeasures. (Prerequisite(s): Grade of "C" or better in CSCI 1523 and CSCI 2420) 4C/4/0/0

CSCI 2560 Introduction to Computer Games

This course deals in an elementary and introductory manner with the design and creation of computer games. Students will be expected to develop computer games from conception through implementation in this course. Game programming in this course will focus on “interactive” gaming rather than strategic gaming. Students are expected to have a familiarity with programming before entering this course. The work for this course will include a variety of projects. (Prerequisite(s): CSCI 1410 and CSCI 1541) 4C/4/0/0

CSCI 2570 Machine Architecture and Organization

This course covers basic hardware and software structure; I/O and main memory organization; internal representation of data; addressing methods; program controls; microprocessor families; multiprocessors; concurrent programming and synchronization; and RISC architectures. Students in this course will become proficient in assembly level programming and will extend this knowledge to higher level languages such as language C. Students are expected to devote a significant amount of time in analyzing designing and implementing low-level software for this platform. The course is designed around the specifications published by the ACM and IEEE for a course on Computer Organization and Architecture. (Prerequisite(s): CSCI 1523) 4C/4/0/0

CSCI 2597 Special Topics in Computer Science

This course provides learning experiences that meet the needs of students, major programs, and the College in the area of computer science. (Prerequisite(s): Instructor approval) Variable credits 1-6

CSCI 2622 Client Side Programming 2

This course is an advanced course in JavaScript programming for the client and the server. It covers key technologies such as AJAX, Bootstrap and Node.js. The course begins with the elementary aspects of AJAX programming with practical examples. Next, the bootstrap framework is explored, with a focus on Responsive Web Design to accommodate displays for all devices, from small mobile phones, to medium tablets to large desktop environments. Finally, an introduction to the Node.js runtime environment is explored, including server configuration and fundamental Node.js commands. In addition, advanced JavaScript topics and techniques currently used in industry will be covered. The key elements of the course are hands-on exercises utilizing tools and techniques to develop interactive websites. This course assumes a previous introduction to JavaScript. (Prerequisite(s): CSCI 1450 and CSCI 2440) 4C/4/0/0

CSCI 2628 Programming iOS Devices

This course introduces the software, tools and techniques necessary to program popular iOS Devices from the Apple computer company. Students will learn how to write programs that can run on the iPhone, iTouch and iPad. The course will introduce the software development kits for iOS Devices, Xcode development tools, Objective-C, and the Cocoa graphical library. Students will develop a series of applications during the course. Students in this course are expected to have previous programming experience in language C or C++. (Prerequisite(s): CSCI 1410 and CSCI 1523 and CSCI 1531) 4C/4/0/0

CSCI 2629 Programming Android Devices

This course introduces the software, tools, and techniques necessary to program the mobile devices that utilize the Android operating system and its supporting software development environment. Students will learn how to write programs that can run on any device supporting the Android environment. The course will introduce the software development kits for Android devices, Eclipse based development tools, Java ME, and the supporting graphical library. Students will develop a series of applications during the course. Students in this course are expected to have previous programming experience in the Java programming language. (Prerequisite(s): CSCI 1410 and CSCI 1541) 4C/4/0/0

CSCI 2630 Metaverse Application Development

This course covers the conceptualization, design, development and deployment of a programming application that will execute as part of a Metaverse environment. The focus of the course is to add behavior to the virtual world we term a Metaverse. The Java programming languages are used in the course and programming applications will be developed in this language. The term project, which will be a large part of the course, will be designed conceptually, programmed in Java and deployed in a metaverse. Students are expected to have a background in Java programming and strong interest in multiuser game programming. (Prerequisite(s): CSCI 1541) 4C/4/0/0

CSCI 2632 Metaverse Graphics Programming

This course is a three-dimensional graphics application programming course which uses the OpenGL library as a graphics programming library standard. Students in this course will be expected to program three-dimensional objects, both active and passive, that will be placed in a three-dimensional Metaverse. Students are expected to develop advanced graphics applications that utilize knowledge of algebra, geometry and physics. Programs will be deployed into a Metaverse environment and a significant part of the course is the development and successful deployment of such applications. (Prerequisite(s): CSCI 1541 and CSCI 2630) 4C/4/0/0

CSCI 2690 Computer Science Internship

A cooperative work-student program between Saint Paul College Computer Science Program and a business facility to allow the student an employment-like experience. (Prerequisite(s): Instructor approval) Variable 1-8 credits

Cosmetology, Nail Care and Esthetician Courses

CHSN 1598 Body Systems and Diseases

This course presents cells, tissue and organs as they relate to the histology and physiology of the skin, hair and nails and how they work together to form body systems. Major body systems will be explained, along with their impact on the skin, hair and nails. Students will study skin, hair and nail diseases and disorders in order to differentiate between treatable disorders and those that require referral to a physician. (Prerequisite(s): Enrollment in Cosmetology, Nail Technician or Esthetician Program) 4C/3/1/0

CHSN 1599 Preclinic Introduction

Provides an introduction to cosmetology, nail technology and skin care, including professional image, Minnesota laws and rules, safety and sanitation. (Prerequisite(s): High School Diploma or a GED) 4C/3/1/0

COSM 1601 Preclinic Hair Care 1

Provides students with the opportunity to develop basic hair skills with a focus on trichology, shampoo, conditioning, cutting and finishing hair techniques. (Prerequisite(s): Completion of or concurrent with CHSN 1598, CHSN 1599) 3C/0/3/0

COSM 1602 Preclinic Hair Care 2

Provides students with the opportunity to continue to develop hair service skills with a focus on shampooing, conditioning, styling, long hair, wigs and extensions. (Prerequisite(s): Completion of or concurrent enrollment in COSM 1601) 3C/1/2/0

COSM 1603 Preclinic Nail Care

Provides an introduction to nail care including manicuring, pedicuring and artificial nails. (Prerequisite(s): Completion of or concurrent enrollment in CHSN 1598 and CHSN 1599) 3C/1/2/0

COSM 1604 Preclinic Skin Care

Provides fundamental guidelines for maintaining and enhancing the skin through proper skin care, massage, hair removal and makeup.

COSM 1605 Preclinic Hair Color

Provides an introduction to temporary, demi-permanent, permanent and de-colorization hair color services. (Prerequisite(s): Completion of or concurrent enrollment in COSM 1606) 3C/1/2/0

COSM 1606 Preclinic Chemical Control

Provides an introduction to cosmetology chemicals and their applications. This includes curl reformation, permanent waving, soft curl perming and chemical relaxing. (Prerequisite(s): Completion of or concurrent enrollment in COSM 1601 and COSM 1602) 3C/1/2/0

COSM 1620 Advanced Hair Care

Provides advanced skill training, color and chemical reformation in hair cutting and styling. (Prerequisite(s): Completion of or concurrent enrollment in COSM 1605) 4C/1/3/0

COSM 1901 Clinic 1 for Cosmetology Majors

This course is designed to provide clinical practice and performance of previously learned hair, skin and nail skills. This course provides the necessary hours to complete hair, skin and nail care quotas as mandated by the State of Minnesota and to develop proficiency in hair, skin and nail services. (Prerequisite(s): COSM 1602) 3C/0/3/0

COSM 1902 Clinic 2 for Cosmetology Majors

This course is designed to provide clinical practice and performance of previously learned hair, skin and nail skills. This course provides the necessary hours to complete hair, skin and nail care quotas as mandated by the State of Minnesota and to develop proficiency in hair, skin and nail services. (Prerequisite(s): COSM 1602) 3C/0/3/0

COSM 1903 Clinic 3 for Cosmetology Majors

This course is designed to provide clinical practice and performance of previously learned hair, skin and nail skills. This course provides the necessary hours to complete hair, skin and nail care quotas as mandated by the State of Minnesota and to develop proficiency in hair, skin and nail services. (Prerequisite(s): COSM 1602) 3C/0/3/0

COSM 1904 Clinic 4 for Cosmetology Majors

This course is designed to provide clinical practice and performance of previously learned hair, skin and nail skills. This course provides the necessary hours to complete hair, skin and nail care quotas as mandated by the State of Minnesota and to develop proficiency in hair, skin and nail services. (Prerequisite(s): COSM 1602) 3C/0/3/0

COSM 1905 Clinic 5 for Cosmetology Majors

This course is designed to provide clinical practice and performance of previously learned hair, skin and nail skills. This course provides the necessary hours to complete hair, skin and nail care quotas as mandated by the State of Minnesota and to develop proficiency in hair, skin and nail services. (Prerequisite(s): COSM 1602) 3C/0/3/0

COSM 1906 Clinic 6 for Cosmetology Majors

This course is designed to provide clinical practice and performance of previously learned hair, skin and nail skills. This course provides the necessary hours to complete hair, skin and nail care quotas as mandated by the State of Minnesota and to develop proficiency in hair, skin and nail services. (Prerequisite(s): COSM 1602) 3C/0/3/0

COSM 1907 Clinic 7

This course is designed to provide clinical practice and performance of previously learned hair, skin and nail skills. This course provides the necessary hours to complete hair, skin and nail care quotas as mandated by the State of Minnesota and to develop proficiency in hair, skin and nail services. (Prerequisite(s): COSM 1601, COSM 1602, COSM 1603, completion or concurrent enrollment. Co-

Requisites: COSM 1601, COSM 1602, COSM 1603

COSM 1908 Clinic 1 for Nail Technicians

This course is designed to provide clinical practice and performance of previously learned hair, skin and nail skills. This course provides the necessary hours to complete hair, skin and nail care quotas as mandated by the State of Minnesota and to develop proficiency in hair, skin and nail services. (Co-requisite(s): 1603)

ESTH 1651 Clinic 1 for Estheticians

This course is designed to provide clinical practice of previously learned skin care skills. (Prerequisite(s): CHSN 1598, CHSN 1599, ESTH 1645 and ESTH 1650 or concurrent enrollment) 4C/0/4/0

ESTH 1652 Clinic 2 for Estheticians

This course is designed to provide clinical practice of previously learned skin care skills. This course provides the necessary hours to complete skin care quotas as mandated by Minnesota Laws and Rules. (Prerequisite(s): Students must have 480 clock hours and have completed all preceding courses in the Esthetics program, ESTH 1651) 4C/0/4/0

ESTH 1645 Cosmetic Chemistry and Makeup Applications

Chemistry is a science that deals with the composition, structure and properties of matter and how matter changes. This course covers the composition of product ingredients, changes produced by cosmetic products, color theory, make up application techniques, lash and brow tinting and temporary hair removal (Prerequisite(s): CHSN 1598, CHSN 1599, concurrent enrollment or within the same semester) 4C/3/1/0

ESTH 1650 Skin Analysis and Massage

Students will learn to greet customers and to consult in a professional manner. Students will learn to perform draping, skin analysis and proper massage techniques according to client's skin type. Students will learn, in a supervised setting, care and proper use of esthetic equipment. Emphasis is on maintaining safety. (Prerequisite(s): CHSN 1598, CHSN 1599 and ESTH 1645, concurrent enrollment or within the same semester) 4C/1/3/0

**COSM 1951 Salon Operations 1 for Cosmetology/
Nail Technician Majors**

Provides students with additional time to complete the required services and/or hours for licensure. (Prerequisite(s): Completion or concurrent enrollment in COSM 1905 or COSM 1901 or CHSN 1461) 1C/0/1/0

**COSM 1952 Salon Operations 2 for Cosmetology/
Nail Technician Majors**

Provides students with additional time to complete the required services and/or hours for licensure. (Prerequisite(s): Completion or concurrent enrollment in COSM 1905 or COSM 1901 or CHSN 1461) 2C/0/2/0

**COSM 1953 Salon Operations 3 for Cosmetology/
Nail Technician Majors**

Provides students with additional time to complete the required services and/or hours for licensure. (Prerequisite(s): Completion or concurrent enrollment in COSM 1905 or COSM 1901 or CHSN 1461) 3C/0/3/0

**COSM 1954 Salon Operations 4 for Cosmetology/
Nail Technician Majors**

Provides students with additional time to complete the required services and/or hours for licensure. (Prerequisite(s): Completion or concurrent enrollment in COSM 1905 or COSM 1901 or CHSN 1461) 4C/0/4/0

**COSM 1955 Salon Operations 5 for Cosmetology/
Nail Technician Majors**

Provides students with additional time to complete the required services and/or hours for licensure. (Prerequisite(s): Completion or concurrent enrollment in COSM 1906, or COSM 1901 or CHSN 1461) 5C/0/5/0

**COSM 1956 Salon Operations 6 for Cosmetology/
Nail Technician Majors**

Provides students with additional time to complete required services and/or hours for licensure. (Prerequisite(s): Completion or concurrent enrollment in COSM 1905 or COSM 1901 or CHSN 1461) 6C/0/6/0

CHSN 1461 Clinic 1 for Nail Technicians

This course provides students with an opportunity to develop the practical skills necessary in basic nail care and to complete required services and hours for licensure. (Prerequisite(s): CHSN 1407) 3C/0/3/0

CHSN 1470 Sanitation for Hair Braiders

This course presents safety issues and sanitation principles practiced in the service of hair braiding. 2C/2/0/0

ESTH 1610 Legal Risk Management for Estheticians

This course will cover risk, risk management, and professional liability in relation to estheticians providing services in a medical office. Client health and safety as well as personal health and safety will be addressed. Additional topics covered will include OSHA and HIPPA guidelines, scope of practice, liability insurance, client medical and lifestyle history and client expectations. Must be enrolled in Esthetician Advanced Practice AAS or Esthetics Medical Setting Advanced Certificate. 2C/2/0/0

ESTH 1612 Peels and Chemical Exfoliation

Identification of ingredients and their effect on the skin will be covered. Course will provide knowledge of application and depths of chemical peels offered in a medical setting under the supervision of a physician. Must be enrolled in Esthetician Advanced Practice AAS or Esthetics Medical Setting Advanced Certificate. Must be enrolled in Esthetician Advanced Practice AAS or Esthetics Medical Setting Advanced Certificate. (Prerequisite(s): ESTH 1610) 3C/2/1/0

ESTH 1614 Advanced Skin Treatments

This course presents the theory of advanced skin treatments offered in a medical setting under the supervision of a Physician. Included will be the theoretic knowledge of therapeutic peeling of the skin through use of Lasers, permanent hair reduction using lasers, cellular stimulation through the use of Light Emitting Diodes, the therapeutic application of Ultrasound and Micro-current use in both skin and body applications. Must be enrolled in Esthetician Advanced Practice AAS or Esthetics Medical Setting Advanced Certificate. (Prerequisite(s): ESTH 1612) 3C/2/1/0

ESTH 1651 Salon Operations 1 for Estheticians

This course gives students additional time to complete the required services and/or hours for licensure. (Prerequisite(s): Completion or concurrent enrollment in ESTH 1652) 1C/0/1/0

ESTH 1652 Salon Operations 2 for Estheticians

This course gives students additional time to complete the required services and/or hours for licensure. (Prerequisite(s): Completion or concurrent enrollment in ESTH 1652) 2C/0/2/0

ESTH 1653 Salon Operations 3 for Estheticians

This course gives students additional time to complete the required services and/or hours for licensure. (Prerequisite(s): Completion or concurrent enrollment in ESTH 1652) 3C/0/3/0

ESTH 1670 CIDESCO Exam Student Preparation

The CIDESCO Pre exam class will prepare the CIDESCO student candidate for all aspects of the CIDESCO exam including the facial exam, the body exam, additional subjects and the written exam. (Prerequisite(s): Completion of esthetician curriculum) 3C/0/3/0

ESTH 1710 Risk Management for Estheticians

This course will cover risk management, professional liability, infection control, health and safety for advanced practice estheticians. Additional topics will include OSHA, HIPPA, and general theory of common supplements, OTC medications and prescription drugs and their skin effects. (Concurrent enrollment in ESTH 1712, ESTH 1714, ESTH 1716, ESTH 1718 required) 2C/2/0/0

ESTH 1712 Advanced Exfoliation

This course will provide practical knowledge and practice of exfoliation using advanced chemicals and devices including but limited to: peels, dermaplaning and microdermabrasion. Students will learn to recognize and treat skin conditions within scope of practice, use proper classification systems and skin analysis, utilize advanced client consultation techniques, and understand wound healing as it relates to advanced esthetics. This class will also cover advanced training in products and ingredients and proper pre- and post- at home care. (Concurrent enrollment in ESTH 1710, ESTH 1714, ESTH 1716, ESTH 1718 required) 4C/1/3/0

ESTH 1714 Advanced Skin Care Techniques

This course will provide practical knowledge and training in machines and devices used in an advanced practice esthetics setting, including but not limited to: Galvanic, high frequency, skin needling, radio frequency, ultra sonic, micro current, LED. Class will also include training on lymphatic drainage, advanced histology of the skin, client consultation, electrical and light theory and best business practice. (Concurrent enrollment in ESTH 1710, ESTH 1712, ESTH 1716, ESTH 1718 Required) 5C/2/3/0

ESTH 1716 Advanced Clinic 1 for Estheticians

This course is designed to provide clinical practice of previously learned advanced esthetics skills. (Concurrent enrollment in ESTH 1710, ESTH 1712, ESTH 1714, ESTH 1718 required) 4C/0/4/0

ESTH 1718 Advanced Clinic 2 for Estheticians

This course is designed to provide clinical practice for previously learned advanced esthetics skills. (Concurrent enrollment in ESTH 1710, ESTH 1712, ESTH 1714, ESTH 1716 required) 4C/0/4/0

CHSN 2580 Cosmetology Instructor License

This course provides 30 hours of teaching methods for Cosmetology and 8 hours of the laws that support and protect the Cosmetology industry. Must meet Board of Cosmetology Law 2105.0140 and must present a current Cosmetology license to the instructor. 2C/1/1/0

Culinary Arts

CULA 1405 Culinary Arts Foundations 1

This course is made up of two units: "Introduction to Culinary Arts" which is designed to allow the student to become familiar with the hospitality industry, our program and the foundation skills necessary to become a foodservice professional, and "Basic Baking" which is designed to allow the student to develop knowledge and skills necessary to work in a professional baking environment. 2C/0/2/0

CULA 1415 Culinary Arts Foundations 2

This course is made up of two units: "Basic Pantry and Cold Food Production" which is designed to allow the student to develop knowledge and skills necessary to work in the garde manger and pantry areas in a professional foodservice environment, and "Basic Range and Hot Food Production" which is designed to allow the student to develop knowledge and skills necessary to work in a

professional foodservice environment. Foundation stocks, sauces and soups are the major component. Must be taken concurrently with Culinary Arts Foundations 1 or have instructor approval. 4C/0/4/0

CULA 1425 Fundamentals of Pastry

This course provides a thorough exploration into the basics of the sweet kitchen. Students prepare and evaluate a number of pastry fundamentals to a marketable level. (Prerequisite(s): CULA 1405 or instructor approval) 1C/0/1/0

CULA 1435 Butchery and Charcuterie

Covers the processing of meat, fish and poultry items. Issues of grading, yield, market forms and standards are discussed. Many types of meat, fish and poultry are processed in the class. (Prerequisite(s): CULA 1405 or concurrently with CULA 1405) 2C/0/2/0

CULA 1440 Breakfast Cookery

Covers the many types of foods usually associated with breakfast/brunch service. Most of these items will be prepared, served in the class and in a restaurant setting. (Prerequisite(s): CULA 1405 and CULA 1415 or concurrently with CULA 1405) 1C/0/1/0

CULA 1445 Food Service Practicum

Students explore various aspects of quantity food production in a fast-paced, high-volume food service setting. Students are introduced to aspects of quantity range, bake shop, short-order and pantry operations. (Prerequisite(s): CULA 1405 and CULA 1415) 2C/0/2/0

CULA 1455 Food Safety and Sanitation

Develops an understanding of the basic principles of sanitation and safety in order to maintain a safe and healthy environment for the consumer. Optional ServSafe exam provided for certification. 2C/2/0/0

CULA 1465 Culinary Nutrition Theory

Covers the fundamentals of nutrition theory taught from the point of view of the chef. Healthy cooking techniques, dietary requirements and current nutritional research topics are explored. 2C/2/0/0

CULA 1505 Contemporary Bake Shop Production

Allows students to develop production baking skills to a marketable level. (Prerequisite(s): CULA 1455, CULA 1460, CULA 1465, CULA 1490) 2C/0/2/0

CULA 1515 Contemporary Pantry Production

Allows the students to develop marketable production skills in the pantry/cold food area. (Prerequisite(s): CULA 1455, CULA 1460, CULA 1465, CULA 1490) 2C/0/2/0

CULA 1525 Contemporary Range Production

Allows students to develop marketable skills in many aspects of hot food preparation in a production kitchen environment. (Prerequisite(s): CULA 1455, CULA 1460, CULA 1465, CULA 1490) 2C/0/2/0

CULA 1545 Contemporary Quick Fare Production

Allows the student to develop marketable production skills in the Grill/ Short Order cooking area. (Prerequisite(s): CULA 1455, CULA 1460, CULA 1465, CULA 1490) 2C/0/2/0

CULA 1555 Culinary Career Portfolio

This course exposes students to the diverse employment opportunities in the food service industry. Students develop an electronic career portfolio and refine employment securing techniques. (Prerequisite(s): CULA 1405) 1C/1/0/0

CULA 1565 Principles of Culinary Leadership

Allows students to prepare for the transition from employee to supervisor by developing human relations and personnel management skills in a foodservice environment. (Prerequisite(s): CULA 1455, CULA 1460, CULA 1465, CULA 1490 or instructor approval) 2C/1/1/0

CULA 1575 Artisan Baking and Pastry

Introduces students to a variety of upscale scratch cake and pastry items and plated desserts. The course focuses on high quality ingredients, sound production and finishing techniques. (Prerequisite(s): CULA 1425 or instructor approval) 2C/0/2/0

CULA 1585 Introduction to Dining Room Service

The course covers serving techniques and dining room operations through classroom and laboratory experience in the City View Grille Dining Room. (Prerequisite(s): CULA 1405 and CULA 1415) 1C/0/1/0

CULA 1590 Cafe Dining Practicum

Students will develop skills in breakfast cookery and casual lunch fare in the student run City View Grille. (Prerequisite(s): CULA 1505, CULA 1515, CULA 1525, CULA 1545) 2C/0/2/0

CULA 1700 Culinary Externship

This course is designed to expose students to the industry in a 96 hour externship. Students reflect on their experiences through assignments and discussions. (Prerequisite(s): CULA 1445 or instructor approval) 3C/0/0/3

CULA 1705 Sustainable Foods Practicum

Students get an introduction to local and sustainable food systems through working with a local farm to create and serve a farm to table dinner. (Prerequisite(s): CULA 1590) 1C/0/1/0

CULA 2100 Menu Composition and Analysis

Requires students to develop marketable skills in the areas of menu planning, menu analysis, production scheduling and recipe interpretation for different menu settings and operations. Must be taken as a block with CULA 2105-2220. (Prerequisite(s): CULA 1550) 2C/0/2/0

CULA 2105 Applied Restaurant Operations 1

Requires students to develop marketable skills in many aspects of hot and cold food preparation in a fine dining environment. Must be taken as a block with CULA 2105-2220. (Prerequisite(s): CULA 1550) 3C/0/3/0

CULA 2110 Applied Restaurant Operations 2

Requires students to develop marketable skills in many aspects of hot and cold food preparation in a fine dining environment. Must be taken as a block with CULA 2105-2220. (Prerequisite(s): CULA 1550) 3C/0/3/0

CULA 2115 Contemporary Dining Room Service

The course explores and refines advanced aspects of front of the house restaurant operations. Students learn and practice functions of dinner service at the City View Grille. (Prerequisite(s): CULA 1590) 1C/0/1/0

CULA 2220 Sensory Evaluation & Wine Pairing

The advanced culinary student will develop a palate of flavor and aroma profiles, an understanding of food and wine pairing techniques, as well as proper service and wine-making processes. Wine varietals will be professionally sampled and evaluated based upon color, aroma, body and finish in order to cultivate an appreciation for the integral relationship between food and wine. Must be taken as a block with CULA 2105-2220. (Prerequisite(s): CULA 1545 and completion of General Education requirements) 2C/2/0/0

CULA 2225 Garde Manger

The course explores the art of cold food preparation through various mediums. Thorough explorations into cold sauces, pates, terrines, condiments and forcemeats will be highlighted in a contemporary buffet format. (Prerequisite(s): CULA 2220) 1C/0/1/0

CULA 2230 Food/Beverage/Labor Cost Control

Covers the principles of menu pricing and analysis, budgeting and inventory control systems in foodservice operations. (Prerequisite(s): CULA 1490 or Instructor approval) 3C/3/0/0

CULA 2235 Event Based Dining Capstone

The course explores one-off dining experiences in a number of settings. Students learn the process of catering events with a diverse set of standards, expectations and clientele. Students become familiar with all facets of events from the concept and development of the menu through set-up, service and strike of the event. (Prerequisite(s): CULA 2225) 2C/0/2/0

CULA 2600 Advanced Decorating and Pastry

This course emphasizes the preparation, making, production and decoration of cakes. The student's training will focus on learning concepts, procedures and techniques needed to produce market-worthy decorations. (Prerequisites: CULA 1405, CULA 1425) 3C/1/2/0

CULA 2610 Showpieces and Coniserie

This course emphasizes the preparation, making and production of chocolate bonbons, candies and confections. The student's training will focus on learning concepts, procedures and techniques related to chocolate tempering and sugar cooking. (Prerequisites: CULA 1405, CULA 1425) 3C/2/1/0

Culinary Arts - Wine

WINE 1600 Professional Introduction to Wine

Review the origins and history of the vine, vineyard calendar, soil and climate, natural hazards, growing regions and major grape varieties of the world. Examine considerations for harvest of grapes, techniques for making still wines (red, white and rose), techniques for making sparkling and fortified wines, processing and aging techniques and the blending process. Explore grape varieties, regulations, history, culture and traditions: USA, France, Italy, Spain/Portugal, Germany, Australia, South America and South Africa. (Prerequisite(s): Must be 21 years or older. Must be taken concurrently with WINE 1610-1640.) 2C/2/0/0

WINE 1610 Flavor Dynamics of Wine

Experience professional wine evaluation based on sensory (visual, organoleptic) traits. Comparison and analysis of world wine regions. Includes an emphasis on the development of a wine vocabulary and sensory description techniques. (Prerequisite(s): Must be 21 years or older. Must be taken concurrently with WINE 1600-1640.) 2C/1/1/0

WINE 1620 Professional Wine Service

Allows student to develop professional wine service techniques, wine etiquette, glassware/equipment options, building a relationship with the guest and elements of the guests' aesthetic experience. (Prerequisite(s): Must be 21 years or older. Must be taken concurrently with WINE 1600-1640.) 1C/1/0/0

WINE 1630 Strategies for Pairing Food and Wine

Allows student to analyze the rationale behind successful wine and food pairings and the impact of preparation techniques on wine choice. Learn how to enhance wine and food pairing opportunities and improve menu and wine list compatibility. (Prerequisite(s): Must be 21 years or older. Must be taken concurrently with WINE 1600-1640.) 2C/1/1/0

WINE 1640 Wine Marketing

This course will allow students to review legalities, wine market cycles, wine pricing, developing a wine program, building a wine list and wine storage. An important part of the course is to develop strategies for determining your target market, wine merchandising and promotional opportunities, consumer education and building strong repeat business. (Prerequisite(s): Must be 21 years or older. Must be taken concurrently with WINE 1600-1640.) 2C/2/0/0

Digital Graphics and Interactive Multimedia

DGIM 1400 Introduction to Computer Graphics

Introduction to Computer Graphics will introduce students to a wide variety of software applications used in the Visualization Technology area as well as cover the basic theories and practices regarding still image graphics, file formats, animation and color theory. In addition, the importance of an online portfolio will be discussed and a basic portfolio will be constructed. 4C/4/0/0

DGIM 1443 Graphical Web Design 1

This course explores the basics of Adobe Muse 1. Topics include file organization, the Adobe Muse interface, site control, images, text, linking pages, ordered, unordered and defined lists, color schemes, tables and basic layouts. The focus of this course is to introduce the learner to Adobe Muse and develop a simple website using the techniques learned. 2C/2/0/0

DGIM 1444 Graphical Web Design 2

This course explores the more advanced topics of Adobe Muse including frames, rollovers, cascading style sheets, HTML, forms, DHTML, automation, sounds, templates and libraries and troubleshooting. It is recommended that student taking this course have taken DGIM 1443 or its equivalent. 2C/2/0/0

DGIM 1448 Adobe Animate 1

This course introduces the student to Adobe Animate. Topics include common Adobe Animate tasks, the Adobe Animate interface, setting up, modifying, navigating Adobe Animate documents, creating simple graphics, working with text, working with bitmaps and building professional graphics. This is a hands-on course where the students will develop a project using the knowledge gained in class. 2C/2/0/0

DGIM 1449 Adobe Animate 2

This course takes you beyond the basics of DGIM 1448. Topics include adding sounds to Adobe Animate, publishing movies, layer editing, Action Script, importing Quick Time movies into Adobe Animate and creating 3-D effects in Adobe Animate. This is a hands-on course where the students will develop a project using knowledge gained in class. It is recommended that students taking this course have taken DGIM 1448 or its equivalent. 2C/2/0/0

DGIM 1472 Digital Multimedia for Non-Majors

This course is an introduction to digital multimedia tools for students not majoring in the computer careers area of the College. It is an overview course on the subject of digital media and covers a variety of digital media tools such as Photoshop, Audacity, MovieMaker, and other tools of this type. The course will cover the topics of interest to someone planning to use the software and hardware systems for documentary purposes in other coursework areas. 2C/2/0/0

DGIM 1483 Photoshop 1

This course introduces the student to Adobe Photoshop. Topics include the Photoshop interface, hardware and software requirements, file formats, pixels, vectors, resolution, color theory, Photoshop color management, masks, type and topography, painting tools and brushes, layers and layer styles, filters, extraction, liquefy and the pattern maker. This is a hands-on course where the students will develop a project using the knowledge gained in class. 2C/2/0/0

DGIM 1484 Photoshop 2

This course is a continuation of DGIM 1483 Photoshop 1 as a Presentation Media. Topics include image composition, retouching, composting, ImageReady, Web design, print and prepress, actions, and automation. This is a hands-on course where the students will develop a project using knowledge gained in class. (Prerequisite(s): DGIM 1483 Photoshop 1 as a Presentation Media or equivalent knowledge) 2C/2/0/0

DGIM 1490 3D Animation Fundamentals

This course introduces students to the Blender 3D Animation Tool. Topics will include navigating the Blender interface, object creation and editing, Blender modifiers, material & texture application, lighting and camera setup, multi-resolution sculpting, UV texture mapping, particle tools, shape keys and render setups. Students will be expected to develop an individual animation project using techniques from the lessons learned. 4C/4/0/0

DGIM 1540 Blogging Applications

This course introduces various web logging (blogging) applications currently in use today on the World Wide Web, along with common practices used by bloggers. Applications to be covered include Blogger, Tumblr, Twitter, WordPress, plus other newly developed applications. In addition to the general use of these applications, students will be introduced to techniques used for Search Engine Optimization (SEO), web traffic analytics, monetized ad placement, Real Simple Syndication (RSS) support, as well as audio and video blogging options. While there is no prerequisite for this course, students are strongly encouraged to have a basic understanding of the Hyper Text Markup Language (HTML). 2C/2/0/0

DGIM 2520 3D Character Animation

This course continues to explore the features of the Blender 3D Animation Tool. Topics will include rigging and skinning fundamentals, inverse kinematic modeling, 3D sculpting tools, character modeling, re-topology body parts, material application and character walk cycle creation. Students will be expected to develop an individual animation project using techniques from the lessons learned. (Prerequisite(s): DGIM 1490 3D Animation Fundamentals) 4C/4/0/0

DGIM 2521 2D Web Animation

This course introduces students to the fundamentals of digital animation with specific focus on two dimensional software animation tools. Topics will include the 12 basic principles of animation as applied to both hand drawn and computer animation, support for web animation on multiple platforms with emphasis on mobile devices, layer editing, audio and video support as well as integration of traditional still image graphic tools into the animation process. Software used in this class will include but not limited to Processing, Adobe Edge and Stencil, as well as other HTML5 compliant web animation software tools. This is a hands-on course where the students will develop a final project using the knowledge gained in class. 2C/2/0/0

DGIM 2530 Web Based Game Design 1

This course introduces standard techniques and strategies used in traditional two dimensional, web-based video games. Browser-based games will be constructed using HTML 5, Javascript and the Tumult Hype web development environment. Projects will include trivia games, pattern matching games, maze games, logic games and simple casino simulations. Students will develop multiple mini-games for an online, web-based portfolio. (Prerequisite or Co-Requisite: DGIM 2521 2D Web Animation or Instructor Permission) 4C/4/0/0

DGIM 2531 Web Based Game Design 2

This course continues to develop traditional two dimensional web-based video games using Javascript, HTML5 and Tumult Hype. Game projects will include spritesheet animations, side scrollers, dungeon crawlers, moving targets, space themed invasions and various pong-style clones. Students will develop multiple mini-games for an online, web-based portfolio. (Prerequisite: DGIM 2530 Web Based Game Design 1) 4C/4/0/0

DGIM 2560 Illustrator

In this course, the student will discover the capabilities of the Adobe Illustrator software tool. This begins with an overview of vector vs raster graphics fundamentals. Specific techniques will involve navigating and customizing the Adobe Illustrator workspace, demonstrating selection and alignment with various tools, using of

magic wands, item grouping and working with various open and closed path objects. In addition, various transformation techniques including scaling, reflecting, rotating, distorting, shearing and perspective will be explored along with how filters and symbols are used to enhance vector graphic projects. Detailed proficiency will be acquired using the Pen, Pencil, Brush, Layer, Spraycan tools along with a greater understanding of both print and web color theory. Upon completion of this course, the student will complete a final project using techniques from lessons learned. 4C/4/0/0

DGIM 2569 Digital Portfolio Development

This course teaches the student how to create a portfolio. In this course the students will create a digital (web based) and hard copy (paper) portfolio. Topics will include portfolio definitions, design, types, goals, content, organization, and presentation, showing their creative talents to an audience of peers, instructors, and industry professionals. 2C/2/0/0

DGIM 2586 Digital Sound

This course teaches students how to create and edit digital sound for use in computer animation. Topics include analog and digital sound techniques and equipment, analog to digital conversion, basic sound editing, formats and sound conversion, digital to analog conversion and basic sound effect techniques for use in computer animation. 2C/2/0/0

DGIM 2587 Digital Video 1

This course focuses on digital video editing using the Premiere Pro video editing software. Techniques involving multitrack video editing and digital audio integration will be explored, along with the creation of various title effects, fade/transition effects and other standard industry practices. In addition, the topics of video filetype and codecs, demo reel creation, use of other software tools for footage creation and basic video capture techniques will be explored. 2C/2/0/0

DGIM 2588 Digital Video 2

This course focuses on digital video editing using the Final Cut Pro video editing software. Many of the same general techniques covered in DGIM 2587 will be covered but done from the perspective of the Final Cut Pro interface. In addition, video distribution via the web, live video streaming techniques and video integration into the web using the HTML5 standards will be explored. (Prerequisite(s): DGIM 2587 Digital Video 1) 2C/2/0/0

DGIM 2589 Digital Motion Graphics: After Effects

This course introduces the Adobe tool After Effects and explores its usage in video and film post production. Students will learn to animate, alter and compose media in both 2D and 3D space. Various other non-linear editing methods will be explored. Advanced keyframing techniques will be explored in depth, along with other standard post-production techniques used in modern video editing. Various After Effects plug-in usage will be explored, along with the integration of After Effects with other tools in the Adobe suite. Finally, the features of various competing products to After Effects, such as Blender and Jahshaka will be reviewed and compared. (Prerequisite(s): DGIM 2587 Digital Video 1 or concurrent) 2C/2/0/0

DGIM 2591 Computer Graphics & Digital Multimedia Internship

A cooperative work-student program between Saint Paul College's Computer Graphics & Digital Multimedia Program and a business facility to allow the student an employment-like experience. (Prerequisite(s): Instructor approval) Variable credits 2–8

DGIM 2597 Special Topics in Computer Graphics & Digital Multimedia

Provides learning experiences that meet the needs of students, major programs and the College. (Prerequisite(s): Instructor approval) Variable credits 1–6

DGIM 2704 3D Animation Capstone

This course is meant to integrate and expand upon the various animation, video editing and image manipulation skills developed in previous classes in this area. In addition, students are expected to explore new and emerging technologies in the area of animation as part of preparing for future changes in this rapidly changing area. Students will be expected to develop both individual and group animation projects for use in their Internet based portfolio. (Prerequisite(s): DGIM 1490 3D Animation Fundamentals) 4C/4/0/0

Economics**ECON 1710 Introduction to the American Economy**

This introductory course provides a basic overview of economic principles that are useful in understanding the economic system in the United States. The course explores the free market economic model, which is the basis of the American economy. The role of government and the rationale for government intervention is included in this study. The course also provides an introduction to microeconomic and macroeconomic concepts and tools which are demonstrated in discussions of current economic policies, issues, and problems. (Prerequisite(s): READ 0721 with grade of "C" or better or appropriate assessment score) (MnTC: Goal 5) 3C/3/0/0.

ECON 1720 Macroeconomics

Macroeconomics is a social science that studies how our society can achieve economic goals of full employment, price stability, economic growth, and stable balance of trade. International trade and the concept of comparative advantage and restrictive trade policies are explored. From this inquiry, students will be able to demonstrate the effects of trade on a country's economic performance. In addition, economic data is used to measure growth and to compare an economy's growth rates relative to other international growth rates. The United States' fiscal and monetary policies are defined and examined in terms of the effects those policies have on economic performance. Fiscal and monetary policy is also examined in relation to the business cycle. In addition an inquiry is made of the importance and interrelated nature of social institutions in achieving economic goals. (Prerequisite(s): READ 0721 with a grade of "C" or better or appropriate assessment score) (MnTC: Goals 5 & 8) 3C/3/0/0

ECON 1730 Microeconomics

Microeconomics is a social science that studies how our society can maximize its economic welfare by the efficient use of resource and product markets. In order to facilitate this study, microeconomics has developed tools such as market models that simplify the complex real world situations. These tools are abstractions of reality from which basic economic principles can be derived. These principles act as a guide to our private and society's public choices. Fundamental issues covered are supply and demand, elasticity, competitive and non-competitive markets. The text has numerous topical examples such as free trade, interest groups, agricultural policy, advertising, health care and more. (Prerequisite(s): READ 0721 with a grade of "C" or better or appropriate assessment score) (MnTC: Goals 5 & 8) 3C/3/0/0

ECON 1790 Special Topics in Economics

This course is designed to present additional or unique material and learning experiences within a specified discipline. The course will be based on student need, flexibility, and may be designed to meet various transfer and pre-major course requirements. Please see a current Course Schedule for complete course details. (MnTC: Goal 5) Variable credits 1-6

Electrical Technology**ELTN 1410 National Electric Code 1 and Trade Calculations**

This is an introductory course to comprehending the National Electrical Code and the mathematical skills that are required to

perform electrical circuit calculations required in the electrical industry. Students will study the history of the code, the code making process, how changes are adopted into the code and the NEC basic structural components. Technical areas include definitions of technical terms and concepts, applied arithmetic calculations, algebraic functions, trigonometry functions and graphing as they apply to circuit analysis and code requirements. 4C/2/2/0

ELTN 1422 Direct Current Circuit Analysis

This course covers the basic concepts of electricity and DC circuits. Topics included are resistance, current, voltage, power, conductors and insulators. Students will learn methods to mathematically determine electrical quantities using Ohm's law and additional electrical formulas, to determine values in series, parallel and combination circuits. The skills and techniques needed to use electrical multimeters to test and troubleshoot circuits is studied. Hands-on experiments for all DC circuit types will consist of building circuits with power supplies and electrical components, and will be evaluated with electrical multimeters. 5C/3/2/0

ELTN 1432 Alternating Current Circuit Analysis

This course covers the basic concepts of AC circuits. Topics included are the study of electromagnetic principles, sine wave principles and relationships, inductance, capacitance, series and parallel circuits, power, circuit analysis and resonance. Students will learn methods to mathematically determine instantaneous electrical values. Hands-on experiments will include the construction of circuits showing the operation of electromagnets, sine waves, series and parallel resistive, inductive and capacitive circuits. (Prerequisite(s): ELTN 1410 and ELTN 1422) 5C/2/3/0

ELTN 1442 Single-Phase Motors and Generators

This course starts with the basic characteristics of DC motors and DC generators, the types, construction, principles of operation, installation, and maintenance, and formats of controls. Next the student will discover the common types of AC motors used today, the construction, principles of operation, installation and troubleshooting methods. Hands-on experiments using specialized test equipment and electrical meters will include energizing both DC motors and generators and also AC motor types under various load conditions. (Prerequisite(s): ELTN 1410 and ELTN 1422) 5C/2/3/0ELT 5C/2/3/0

ELTN 1512 Three-Phase Systems Motors and Generators

This course covers three-phase theory, wiring system calculations, methods, and installations. Three-phase motors and generators will also be introduced so students can identify, connect, operate, troubleshoot, and maintain them. This course also covers the proper use of three-phase test equipment used to operate, troubleshoot, and maintain the systems studied in this course. 5C/3/2/0

ELTN 1522 Introduction to Electronics and Test Equipment

Students are introduced to semiconductors, study different types of diodes and connect them in typical circuits. Complete power supply circuits are connected, analyzed and tested. This course covers transistor theory, operation, connection, testing, and troubleshooting practices for transistors in amplifier and switching applications. This course covers the use of electrical and electronic test equipment. 5C/2/3/0

ELTN 1532 Intermediate Electronics and PLC's

This course covers transistor theory, operation, connection, testing, and troubleshooting practices for transistors in amplifier and switching applications. It covers transistor the information necessary to gain working and troubleshooting knowledge of thyristors, light, and heat sensitive devices and electrical transducers. Also introduced are programmable logic controllers (PLC's) and it explains how they can be used to control machines and building equipment. Hands-on programming of simple process control examples including system wiring to input/output devices will be fully integrated throughout the course. 5C/2/3/0

ELTN 1540 Low Voltage Systems and Job Site Safety

This course will cover the basic concepts associated with fire and security alarm systems and data communications systems. Hands-on application of components include fire alarm systems, security systems, and data communication and cabling systems. This course will also cover all aspects OSHA job safety for construction electricians. It will address safety issues for awareness rather than compliance purposes. 4C/2/2/0

ELTN 2410 Distribution, Power and Specialty Transformers

This course covers single-phase, Three-phase and specialty transformer operation, including transformer losses, efficiency, and phase relationships. There is extensive math and in-depth coverage of Article 450 of the National Electrical Code. 4C/2/2/0

ELTN 2420 Motor Controls

This course covers design, wiring, and troubleshooting of control and load circuits for single-phase and Three-phase motors. Also covered is the sizing of conductors, circuit short circuit and ground fault protection, and the calculation and proper sizing of motor overload protection. There is also in-depth coverage of Article 430 of the National Electrical Code. 4C/2/2/0

ELTN 2430 Residential Wiring and Blueprint Reading

This course covers the material and design aspect of residential wiring. Topics covered include branch circuit requirements, wiring methods, and the use of blueprints. Related articles in the National Electrical Code are also covered. 4C/1/3/0

ELTN 2440 Heating and Cooling System Controls

This course covers the control of heating and cooling systems in residential and commercial situations. Gas, oil, and electric systems are covered. Related articles in the National Electrical Code are also covered. 4C/2/2/0

ELTN 2510 Wiring Methods and Systems

This course covers the methods used to deliver power in a safe and efficient electrical installation. Conductor properties and various configurations are discussed and installed. (Prerequisite(s): ELTN 2410, ELTN 2420, ELTN 2430, ELTN 2440) 4C/2/2/0

ELTN 2522 Commercial Wiring Methods

This course covers the design, material usage and safe installation practices on commercial job sites. Power tool safety and usage is applied in a hands-on mockup setting. (Prerequisite(s): ELTN 2410, ELTN 2420, ELTN 2430, ELTN 2440) 5C/2/3/0

ELTN 2532 Industrial Wiring Methods and Service Entrance

This course covers the design, material usage and safe installation practices on industrial job sites. Requirements and safe installation of service entrance equipment and conductors are also covered. (Prerequisite(s): ELTN 2410, ELTN 2420, ELTN 2430, ELTN 2440) 5C/2/3/0

ELTN 2540 National Electrical Code 2

This course takes an in-depth look at the requirements of chapters one through 5 in the current National Electrical Code. Compliance is discussed in the classroom and reinforced in a hands-on mockup setting. (Prerequisite(s): ELTN 2410, ELTN 2420, ELTN 2430, ELTN 2440) 4C/2/2/0

ELTN 2550 Introduction to Renewable Energy

This course presents a discussion of renewable energy systems and resources such as solar, wind, hydro and geothermal. Topics will include photovoltaic cells, solar panels and arrays. In addition, students will learn about generation and effectiveness of various renewable energy systems. 2C/2/0/0

Electromechanical Systems

EMEC 1511 AC/DC Fundamentals

This course is an introduction to electrical power and relay control systems found in modern industrial machinery and automation. Topics include electricity basics, parts of an electrical circuit, use of a multimeter, understanding transformers, electrical relay control, and electro-pneumatic devices. 4C/2/2/0

EMEC 1521 Electrical Motors

This course is an introduction to electrical motors and generators found in modern industrial machinery and automation. Topics focus on the various types of AC and DC motors. 4C/2/2/0

EMEC 1530 Motor Controls

This course is an introduction to electrical motor controls found in modern industrial machinery and automation. The learning is based on practical online instruction and classroom hands-on tasks involving electronically operated devices and associated peripheral equipment. Topics include motor protection, braking, running on reduced power, and sensor controls. 4c/2/2/0

EMEC 1540 Motor Drives

This course is an introduction to electronic motor drives found in modern industrial machinery and automation. The learning is based on practical online instruction and classroom hands-on tasks involving electronically operated devices and associated peripheral equipment. Topics include variable frequency drives, inverters, position and velocity controls. 4c/2/2/0

EMEC 2400 Industrial Basics

This course is designed to align with the Manufacturing Skill Standards Councils (MSSC) assessment and certification system for manufacturing processes. The course curriculum is based upon federally-endorsed national standards for production workers. Students will learn about Just-In-Time (JIT) manufacturing principles, basics supply chain management, communication skills, customer service, corrective actions, preventative actions, control of documents, control of quality records, internal auditing of processes, and control of nonconforming product. 4C/2/2/0

EMEC 2500 Fluid System Fundamentals

This course is an introduction to hydraulic and pneumatic systems found in modern industrial machinery and automation. Topics include basic laws of fluid mechanics, standard symbols, pumps, control valves, control assemblies, actuators, test equipment, and proper safety procedures. 4C/2/2/0

EMEC 2610 Fluid System Fundamentals – Pneumatics

This course is an introduction to pneumatic power systems found in modern industrial machinery and automation. The learning is based on practical online instruction and classroom hands-on tasks involving pneumatically operated devices and associated peripheral equipment. Topics include basic laws of fluid mechanics, standard symbols, pumps, control valves, control assemblies, actuators, maintenance procedures, test equipment, electric and pneumatic switching/control devices, and proper safety procedures. Online learning computer simulation and 3D software will be used throughout the course as well as laboratory pneumatic equipment. (Prerequisite(s): Journeyman electrician or ELTN/CNEL diploma/AAS) 3C/0/3/0

EMEC 2615 Fluid System Fundamentals – Hydraulics

This course is an introduction to hydraulic fluid drive systems found in modern industrial machinery and automation. The learning is based on practical online instruction and classroom hands-on tasks involving hydraulically operated devices and associated peripheral equipment. (Prerequisite(s): Journeyman electrician or ELTN/CNEL diploma/AAS or instructor approval) 3C/0/3/0

EMEC 2620 Mechanical Fundamentals 1

This course is an introduction to mechanical drive systems. Topics include the transfer of mechanical power through chain/gear/belt drive systems, alignment of drives to loads, and drive component lubrication. The class material will be delivered through online instruction and hands-on labs focusing on various types of drive systems. (Prerequisite(s): Journeyman electrician or ELTN/CNEL diploma/AAS or instructor approval) 4C/2/2/0

EMEC 2625 Mechanical Fundamentals 2

This course continues the work in Mechanical Fundamentals 1 by providing a deeper understanding of mechanical drive systems and introducing the student to various pump systems. The class material will be delivered through online instruction and hands-on labs focusing on various types of bearings, gaskets, drives, and pumps. (Prerequisite(s): Journeyman electrician or ELTN/CNEL diploma/AAS or instructor approval) 4C/2/2/0

EMEC 2741 Electromechanical Troubleshooting and Maintenance

This course introduces students to basic troubleshooting and maintenance techniques used in the industry. Topics include understanding the difference between troubleshooting and maintenance, common issues with basic electromechanical equipment, professional communication, team management, and conflict resolution within a team environment. 4/2/2/0 (Prerequisites: Journeyman electrician or ELTN/CNEL diploma/AAS or instructor approval). (Co-requisite(s): EMEC 2751 Automated Process Controls, EMEC 2760 Programming for Robotic Manufacturing, Advanced PLC Programming.)

EMEC 2751 Automated Process Controls

This course will cover the essential elements of a process control system. Topics include closed and open loop processes, variable measurement, instrument calibration, and various loop controllers. The learning is based on practical online instruction and hands-on tasks involving level, flow, pressure, and temperature controlled process loops. (Prerequisite(s): Journeyman electrician or ELTN/CNEL diploma/AAS) 4C/2/2/0

EMEC 2760 Programming for Robotic Manufacturing

This course focuses on programming robotics that specialize in manufacturing settings. Topics include robotic safety, homing, programming for automatic and manual operations, work cell coordination, and robotic quality control. The learning is based on practical online instruction and hands-on programming involving an expanding robotic platform. 4C/2/2/0

EMEC 2770 Advanced PLC Programming

This course builds a deep understanding of a Programmable Logic Controller (PLC), a specialized computing system used to automate various industrial settings. Topics include digital and analog input and output modules, internal registers and tables, function block usage, networking, and how to use a PLC to aid in troubleshooting. The learning is based on practical online instruction and hands-on tasks that focus on interacting with PLCs. (Prerequisite(s): Journeyman electrician or ELTN/CNEL diploma/AAS or instructor approval) 4C/2/2/0

Engineering (Pre)**ENGR 1706 Principles of Engineering**

Principles of Engineering is a broad-based survey course designed to help students understand the field of engineering and engineering technology and the career pathways. Students are introduced to engineering fundamentals and the knowledge and skills necessary for success as professional engineers and engineering technologies. This course is required for students enrolled in the Science Technician AS degree program. Engineering students should register for ENGR 1707. 2C/1/1/0

ENGR 1707 Introduction to Engineering

Introduction to Engineering is a broad-based course designed to help students understand the field of engineering and engineering technology and the career pathways. Students are introduced to engineering fundamentals and the knowledge and skills necessary for success as professional engineers and engineering technologies. Topics include an overview of the engineering profession, engineering design, manufacturing, use of computer packages, and technical communication. Engineering graphics and solid modeling will be presented including the use of a solid modeling software. This course is required for students enrolled in the Pre-Engineering AS degree program. 3C/2/1/0

ENGR 1709 Digital Electronics

Digital Electronics is the study of electronic circuits that are used to process and control digital signals. Digital Electronics is the foundation of all modern electronic devices such as cellular phones, MP3 players, laptop computers, digital cameras, high definition televisions, etc. In this course, students will be exposed to combinational and sequential logic design, microcontrollers, soldering. It is a project based course requiring use of problem solving, and teamwork, and communication skills to analyze, design, and build digital electronic circuits. 3C/1/2/0

ENGR 1712 Computer Integrated Manufacturing

Computer Integrated Manufacturing (CIM) describes the process of automation of a manufacturing plant with all processes functioning under computer control. In this course, students will explore how things are made, the processes that go into making different types of products, how automation changed manufacturing, and automation processes and basic programming for control systems and robots. (Prerequisite(s): Completion of or concurrent enrollment in ENGR 1706 Principles of Engineering) 2C/1/1/0

ENGR 1714 Engineering CAD

This course introduces students to solid modeling software used in engineering for design and analysis of parts. It includes creating models and drawings for basic extrusions, revolve features, and cuts as well as more complex blends, sweeps and assemblies. 2C/1/1/0

ENGR 1717 Circuit Analysis

This course is meant to develop circuit analysis skills in DC and AC circuits. It includes circuit laws and theorem, mesh and node analysis, natural and step response of RL, RC, and RLC circuits. (Prerequisite(s): PHYS 2710 and MATH 2760 or instructor approval) 4C/3/1/0

ENGR 1790 Special Topics in Engineering

This course is designed to present additional or unique material and learning experiences within a specified discipline. The course will be based on student need, flexibility, and may be designed to meet various transfer and pre-major course requirements. Please see a current Course Schedule for complete course details. Variable credits 1-6

ENGR 2700 Introduction to Problem Solving & Engineering Design

This class introduces the student to a multifaceted engineering problem solving and design paradigm. In this course, students will learn a systematic engineering approach to solving a problem, engineering design process, and technical presentation and analysis of data. Students will be introduced to mathematical, spreadsheet and solid modeling software for use in engineering problem solving. Open-ended activities and design projects will provide opportunities for students to apply common elements of problem solving in the solution of engineering problems in the context of a structured problem solving and design process. (Prerequisite(s): ENGR 1706) 2C/1/1/0

ENGR 2705 Statics

Statics is the first area of study in the science of mechanics. Statics deals with the study of rigid bodies at rest and the forces acting on them. Statics is the foundational course for many fields in engineering including civil, mechanical, biomedical, and structural. In this course, students will use Newton's three laws of motion to solve equilibrium of particles and rigid bodies on both 2D and 3D; determine centroids and moments of inertia; solve for internal and external forces in trusses, beams, and frames; and develop shear and moment diagrams. (Prerequisite(s): PHYS 2700 or instructor approval) 3C/3/0/0

ENGR 2710 Dynamics

This course continues the development of fundamental engineering concepts. Topics include kinematics and kinetics of particles, systems of particles and rigid bodies, work-energy, linear and angular impulse momentum. (Prerequisite(s): Grade of "C" or better in ENGR 2705) 3C/3/0/0

ENGR 2712 Deformable Body Mechanics

This course focuses on the application of the principles of mechanics of deformable bodies including the underlying concepts of stress and strain. The course further examines the relationships among loads on deformable bodies, the stresses and strains within those bodies and the deformations and stability of those bodies. Topics include: uniaxial loading and deformation, stress and strain at a point, combined stress states, Mohr's circle, internal forces in beams, material behavior, and torsion of circular shafts. (Prerequisite(s): ENGR 2705) 3C/3/0/0

ENGR 2715 Thermodynamics

This course covers basic thermal energy relationships, processes, and cycles, First and Second Law of Thermodynamics, entropy, and availability. This course is intended for engineering majors and includes open-ended design. (Prerequisite(s): Grade of "C" or better in CHEM 1711 and PHYS 2700) 3C/3/0/0

English

ENGL 0921 Fundamentals of Writing 1

This course is designed for beginning writers who need additional foundational writing instruction and experience. It provides sequenced instruction in grammar usage, sentence construction, paragraph unity and coherence, and the writing process. Students will study models of effective sentences and paragraphs and then generate their own work. Additionally, this course will focus on building vocabulary for fluency and precision in communication. Completion of this course with a grade of "C" or better is required to continue on to ENGL 0922. (Prerequisite(s): READ 0721, department approval or appropriate assessment score) 4C/4/0/0

ENGL 0922 Fundamentals of Writing 2

This course provides credits for certificate and diploma programs and is preparation for ENGL 1711. In addition to reviewing sentence mechanics, students will study a variety of writing models in both paragraph and essay formats. Students must pass the course with a "C" or better in order to move on to ENGL 1711. (Prerequisite(s): Grade of "C" or better in ENGL 0921 and READ 0721 or appropriate assessment score.) 4C/4/0/0

ENGL 1711 Composition 1

This course emphasizes the process of writing expository and persuasive essays using effective writing skills and a variety of research techniques. The course includes an analysis of primary and/or secondary sources with a focus on critical reading, logical reasoning and academic research writing. (Prerequisite(s): Grade of "C" or better in READ 0722 Reading 2, ENGL 0922 Fundamentals of Writing 2 with a grade of "C" or better, or appropriate assessment score) (MnTC: Goal 1) 4C/4/0/0

ENGL 1712 Composition 2

This course emphasizes critical reading and analytical writing using literature as the basis for composition. The course includes an analysis of primary and/or secondary sources with a focus on academic writing. (Prerequisite(s): Grade of "C" or better in ENGL 1711) (MnTC: Goal 1) 2C/2/0/0

ENGL 1720 Introduction to Creative Writing

In this course, we will explore creative writing through reading, analysis, discussion and by writing in three genres: poetry, short story and creative nonfiction. Students will develop an understanding of creative writing techniques and the elements of literature through analysis of literary technique and applying knowledge of craft technique to their own work. Students will learn writing techniques through exercise and practice. Students will analyze and respond critically to poetry, fiction and creative nonfiction in the texts and works produced by peers through reading, discussion, group work, workshops and in writing in order to practice an informed response to creative literature. Students will be encouraged to investigate publication opportunities for their own original writing and to present their own original work in a public reading at the end of the semester. (Prerequisite(s): Grade of "C" or better in ENGL 1711) (MnTC: Goal 6) 3C/3/0/0

ENGL 1725 Introduction to Fiction Writing

This writing intensive course will explore and analyze fictional writing elements (dialogue, setting, character, cause and effect, theme, conflict, resolution etc.) through critical reading of short stories. Learners will discuss and critique literature and their own writing using workshop sessions to explore writing goals and hone creative and critical writing analysis techniques. Learners will develop an understanding of fiction by applying these techniques to our own writing and in discussion of peers' work. In this course, learners will express a new understanding of fiction writing techniques by applying informed and critical responses to classic and contemporary fictional pieces. Learners will examine the writing process by practicing writing exercises, creating short fiction pieces, examining writing elements through critical reading responses and exams, and by investigating opportunities and tendencies in writing through revision. (Prerequisite(s): ENGL 1711 Composition 1 with a grade of "C" or better) (MnTC: Goal 6) 3C/3/0/0

ENGL 1730 Introduction to Technical Writing

Introduction to Technical Writing is a college-level, introductory course emphasizing workplace writing and communication useful in professional, business, and vocational/technical fields. There will be attention to clear, correct and effective writing necessary for success in the workplace. Assignments include internal and external communication, including e-mail, formal correspondence and memos, researched formal and informal reports, proposals and requests for proposals, instructions, writing for Internet publication, and production of an application packet. Students will be asked to consider audience analysis, usability, workplace writing ethics, and produce work appropriate for Internet publication. (MnTC: Goal 1) 3C/3/0/0

ENGL 1735 Introduction to Non-Fiction- Memoir Writing

In this writing intensive course, we will explore and analyze nonfiction and memoir essay-writing elements (dialogue, setting, narration, structure, theme, conflict, resolution, etc) through critical reading of creative nonfiction essays. By discussing and critiquing creative nonfiction and our own writing using workshop sessions to explore our classmates' writing goals, we will hone creative and critical writing analysis techniques. We will develop an understanding of creative nonfiction and memoir by applying these techniques to our own writing and in discussion of our peers' work. In this course, we will learn to express our new understanding of creative nonfiction writing techniques by applying informed and critical responses to diverse and contemporary nonfictional pieces. By practicing creative nonfiction writing exercises, creating our own nonfiction pieces, examining writing elements through critical reading responses and exams, and by investigating opportunities and tendencies in our

own writing through revision, we will examine the writing process. We will also explore current creative nonfiction writing trends and publication possibilities. (Prerequisite(s): ENGL 1711 Composition 1 with a grade of "C" or better, or appropriate assessment score) (MnTC: Goal 6) 3C/3/0/0

ENGL 1770 Introduction to Poetry Writing

In this writing intensive course, we will analyze and craft poetry by exploring its elements (tone, diction, imagery, symbolism, rhythm, metaphor, theme, etc.) through critical reading and writing of poems. By discussing and critiquing poetry and our own writing using workshop sessions to explore our classmates' writing goals, we will hone creative and critical poetry analysis techniques. We will develop an understanding of poetry by applying these techniques to our original writing and in discussion of our peers' work. In this course, we will learn to express our new understanding of poetry writing techniques by applying informed and critical responses to classic and contemporary poems and applying them to the poems we create. By practicing poetry writing exercises, creating poems, examining writing elements through critical reading responses and exams, and by investigating opportunities and tendencies in our poetry drafts through revision, we will examine the poetry writing process. We will also explore current poetry writing trends and publication possibilities. (Prerequisite(s): ENGL 1711 Composition 1 with a grade of "C" or higher) (MnTC: Goal 6) 3C/3/0/0

ENGL 1780 Recently-Arrived Contemporary Immigrant Literature

Some of the most compelling contemporary American literature has been written by first and second-generation immigrants to the United States. This course will cover a number of works that explore the difficult process of cultural adjustment for writers of various racial and ethnic groups. The course will cover the larger narrative of coming to America but also focus on particular literary, socio-cultural and historical issues. Students will discover how language and narrative strategies are employed by writers to create the stories of their lives: intergenerational conflicts, difficulties tied to language and the formation and re-formation of racial and ethnic identities as writers confront the demands of a new country and life. Immigration and naturalization laws at various moments in US history and how those laws have influenced contemporary literature will be discussed. (Prerequisite(s): ENGL 1711 Composition 1 with a grade of "C" or better) (MnTC: Goals 6 & 7) 3C/3/0/0

ENGL 1790 Contemporary Writers of Color

This course examines American literature as a multi-voiced body and considers the contributions to that body by writers of color. Under consideration are writings by Native American, Asian American, African American and Latino authors. Particular attention will be given to issues of race, gender, ethnicity, class and sexuality and how these issues are reflected in the complicated construction of identity. As a means of considering how various racial identities are constructed and expressed in literature, contemporary and recently-published work by writers from these groups will be read. In order to provide appropriate context for readings and discussions, the class will consider relevant cultural and social histories of these writers as well. (Prerequisite(s): ENGL 1711 Composition 1 with a grade of "C" or better) (MnTC: Goals 6 & 7) 3C/3/0/0

ENGL 2721 Survey of American Literature 1

A survey of American poetry, essays, novels and short stories from colonial times to the end of the Civil War. This course will help the student to discover the definitions of these distinctive genres, their unique boundaries and potential and what distinguishes them from other forms of writing. The historical, political and cultural background of the time will also be covered in this course, so that the student will find the readings to be more interesting and accessible. (Prerequisite(s): Grade of "C" or better in ENGL 1711) (MnTC: Goals 6 & 7) 3C/3/0/0

ENGL 2722 Survey of American Literature 2

A survey of American poetry, essays, novels and short stories from the end of the Civil War to the present. A continuation of Survey of American Literature 1. This course will help the student to discover the definitions of these distinctive genres, their unique boundaries and potential and what distinguishes them from other forms of writing. The historical, political and cultural background of the time will also be covered in this course, so that the student will find the readings to be more interesting and accessible. While not a requirement, the student will find this course more enjoyable if he has first taken Survey of American Literature 1. (Prerequisite(s): Grade of "C" or better in ENGL 1711) (MnTC: Goals 6 & 7) 3C/3/0/0

ENGL 2725 Survey of British Literature

This college literature course, intended for all students, will introduce British literature. Beginning with the Old English and spanning to the Modernists of the early twentieth century, students will read, discuss, and analyze a variety of texts such as poems, essays, letters, and selections from novels. Typical works and authors may include Beowulf, Chaucer, Milton, Shakespeare, and Swift. The course will consider what these works reveal about British society as well as what they suggest about the human condition. (Prerequisite(s): ENGL 1711 Composition 1 with a grade of "C" or better) (MnTC: Goal 6) 3C/3/0/0

ENGL 2730 Contemporary American Novel

A study of the American novel from the late nineteenth century to the present. Beginning with realistic novels that reflected vast social changes at the turn of the century, this course seeks to discover the unique boundaries and potential of the contemporary American novel, what distinguishes it from other forms of literature and how the form changed as the American culture changed. The historical, political and cultural background of the time will also be covered in this course, exploring how issues like feminism, civil rights, workers' rights and the rise of youth culture are reflected in American literature. This course ends with the contemporary novels of the twenty-first century. (Prerequisite(s): Grade of "C" or better in ENGL 1711 Composition 1) (MnTC: Goal 6) 3C/3/0/0

ENGL 2732 Exploring the Short Story

This course will focus on analysis of short stories in the context of a genre, a theme, or an author. We will consider the short stories' historical contexts, their critical commentary, and their cultural significance as reflected in the time periods in which they were written. We will discuss the themes and values expressed in these short stories and examine how they impact us as readers. (Prerequisite(s): Grade of "C" or better in ENGL 1711 Composition 1) (MnTC: Goal 6) 3C/3/0/0

ENGL 2750 African American Literature

Through an analysis of structural and thematic elements, this course seeks to discover the unique additions that African American writers have brought to the traditional literary canon. Special attention will be given to the historical and cultural periods, such as the Harlem Renaissance. Moreover, this course is designed to introduce how African American literary criticism has been instrumental in validating and placing African American works in a literary tradition. (Prerequisite(s): Grade "C" or better in ENGL 1711 Composition 1) (MnTC Goals: 6 & 7) 3C/3/0/0

ENGL 2755 LGBTQ Writers

This college literature course, intended for all students, will study works written by members of the LGBTQ community and exploring their experience. We will analyze course readings with a special focus on the distinct concerns, perspectives, and challenges of lesbian, gay, bi-sexual, transgender and queer writers. We will view the works both historically, with an emphasis on the issues and challenges of LGBTQ writers within their own time frame, and from a contemporary perspective. The class will also explore the literature of various races and ethnicities within the family of LGBTQ writers. (Prerequisite: ENGL 1711 Composition 1 with a grade of C or better) (MnTC: Goals 6 and 7) 3C/3/0/0

ENGL 2760 English Novel

Why did the novel as a genre emerge in England during the beginning of the 18th century? Beginning with Daniel Defoe's *Moll Flanders*, this course seeks to discover the unique boundaries and potential of the English novel, what distinguishes it from other forms of literature and how the form changed as the English culture changed. The historical, political and cultural background of the time will also be covered in this course, so that the student will find the readings to be more interesting and accessible. (Prerequisite(s): Grade of "C" or better in ENGL 1711 Composition 1) (MnTC: Goal 6) 3C/3/0/0

ENGL 2770 Introduction to Poetry

This course will focus on the formal aspects of meter and prosody in order to objectify and demystify meaning in poetry. This course will help the student discover the various poetic forms and why a poet would choose one form over the other. In order to facilitate meaning, lectures and additional reading will focus on the social and political climates in which the poems were written. (Prerequisite(s): ENGL 1711 Composition 1 with a grade of "C" or better) (MnTC: Goal 6) 3C/3/0/0

ENGL 2775 Introduction to Speculative Fiction and Fantasy Literature

This course will explore science fiction and fantasy through close and comparative readings of various texts. Together we'll consider how the writers of these genres respond to the various challenges of the twenty-first century, including shifting gender, politics, war, and the impact of new technologies on culture. This course will largely be concerned with the twin goals of articulating the writer's critique of present social conditions and exploring how those critiques are constructed. (Prerequisite(s): ENGL 1711 Composition 1 with a grade of "C" or better) (MnTC: Goal 6) 3C/3/0/0

ENGL 2776 Women Writers

This college literature course, intended for all students, will explore literature written in English by women. We will analyze course readings with a special focus on the distinct concerns, perspectives, and challenges of women writers. In addition, we will examine the social and cultural contexts in which these works were written, developing our understanding that literature can reflect, critique, and even shape its cultural moment. (Prerequisite(s): ENGL 1711 Composition 1 with a grade of "C" or better) (MnTC: Goals 6 & 7) 3C/3/0/0

ENGL 2778 Urban Literature—Lost in the City

This course explores contemporary literature in the context of the urban landscape. Together, we'll explore the function of the city in literature with attention to how characters both shape and are shaped by an urban existence. Also, how do various writers portray the city? As a labyrinth? A market place of cross-cultural encounters? A place of refuge? A dystopia? Through close and comparative readings, we'll construct an informed understanding of how and why a city is portrayed by a particular writer and to what degree the city itself functions as a meaningful character in literature. (Prerequisite(s): ENGL 1711 Composition 1 with a grade of "C" or better) (MnTC Goal: 6) 3C/3/0/0

ENGL 2790 Special Topics in English

This course is designed to present additional or unique material and learning experiences within a specified discipline. The course will be based on student need, flexibility, and may be designed to meet various transfer and pre-major course requirements. Please see a current Course Schedule for complete course details. (MnTC: Goal 1) Variable credits 1-6

English for Academic Purposes (EAPP)

EAPP 0760 High Intermediate Reading & Vocabulary

This course introduces English learners to academic reading skills at the high intermediate level. Students identify main ideas and details, use pre-reading strategies, and infer meaning in non-fiction and short

stories. Students also build their vocabulary through the study of word parts, the academic word list, and dictionary skills. This is a required course. (Prerequisite(s): Appropriate assessment score) 5C/5/0/0

EAPP 0770 High Intermediate Writing and Grammar

This course introduces English learners to academic writing at the high intermediate level. Students will improve their ability to write clear, correct sentences and well-organized paragraphs. They will study parts of speech, sentence structure, and basic verb tenses. They will also become familiar with the writing process and using a computer to create, save and edit their work. This is a required course. (Prerequisite(s): Appropriate assessment score) 5C/5/0/0

EAPP 0780 High Intermediate Speaking and Listening

This course introduces English language learners to academic speaking and listening skills at the high intermediate level. Students will deliver presentations, participate in group discussions, and take lecture notes. In addition, students will improve their pronunciation, vocabulary, and grammar and apply their language skills to learn about campus resources and engage in the college community. Use of the multimedia language laboratory is part of this course. This is a required course. (Prerequisite(s): Appropriate assessment score) 5C/5/0/0

EAPP 0860 Advanced Reading & Vocabulary

This course develops academic reading and vocabulary skills at the advanced level. Students analyze main ideas and details, use a variety of reading strategies, and summarize passages from authentic non-fiction texts and novels. Students further develop their academic vocabulary through the study of the academic word list, context clues, and dictionary skills. This is a required course. (Prerequisite(s): Appropriate assessment score or completion of EAPP 0760 with a grade of "C" or better) 5C/5/0/0

EAPP 0870 Advanced Writing & Grammar

This course develops academic writing skills at the advanced level. Students will improve their ability to write clear, correct sentences and well-organized paragraphs and essays. They will also study advanced sentence and grammar structures and apply this grammar knowledge in a variety of writing situations. This course emphasizes the writing process, basic research skills, and the use of online materials. This is a required course. (Prerequisite(s): Appropriate assessment score or completion of EAPP 0770 with a "C" or better) 5C/5/0/0

EAPP 0880 Advanced Speaking & Listening

This course develops advanced speaking and listening skills for English learners. Students will summarize lectures, lead small group discussions, and deliver presentations based on simple research. Students will also learn appropriate communication strategies for the U.S. college classroom and explore career and major programs. Use of correct grammar, clear pronunciation and academic vocabulary will be reinforced throughout the semester. Regular use of the multimedia language laboratory is part of this course. This is a required course. (Prerequisite(s): Appropriate assessment score or completion of EAPP 0780 with a grade of "C" or better) 5C/5/0/0

EAPP 0900 Academic Reading & Writing

In this course, English language learners will develop analytical reading and writing skills. They will read, analyze, and respond to a variety of texts and build academic vocabulary. Students will also study advanced sentence, grammar and rhetorical structures and apply this knowledge to produce clear and effective essays. This is a required course. (Prerequisite(s): Appropriate assessment score or completion of EAPP 0860 & EAPP 0870 with a "C" or better) 5C/5/0/0

EAPP 1400 English Pronunciation for Academic and Professional Purposes

This course is designed for English learners who want to improve their English pronunciation. Students will apply rules for sound

production, word stress, sentence stress, intonation, rhythm, and speech patterns through modeling, group work, role plays, and presentations. Students develop self-monitoring skills to apply pronunciation skills to academic and professional settings in their major or career area. Students will soften (not eliminate) their accent and gain more confidence when they speak. Students at any level are accepted, no prerequisites are required. 2C/2/0/0

EAPP 1490 Special Topics in English for Speakers of Other Languages

This course is designed to present additional or unique material and learning experiences within a specified discipline. The course will be based on student need, flexibility, and may be designed to meet various transfer and pre-major course requirements. Please see a current Course Schedule for complete course details. Variable credits 1-6

Geographical Information Science

GISC 1760 Introduction to GIS

This course introduces students to fundamental and applied concepts in geographic information systems. Students will become intimately familiar with the use of rasters and vectors in a digital computer environment and learn how to use specialized GIS software (ESRI's ArcGIS suite of products) to import, display, create, manipulate, and analyze digital spatial data. The ultimate goal of this course is to teach students to become effective GIS practitioners that understand the theory related to GIS and appreciate the limitations and strengths of GIS. 4C/4/0/0

GISC 1765 Cartography

This course introduces students to the art and science of making maps. Students will examine concepts related to scale, map projections, shape, proportion, color, human cognition of space, and the spatial arrangement of information in maps. The ultimate goal of this course is to teach students how to effectively convey a message with a map that contains subjectively selected features representing a simplified version of the outside world. 3C/3/0/0

GISC 1770 Spatial Thinking

Students taking this course will receive a broad introduction to the discipline of geography and use it as a building block for learning how to conceptualize spatial information in landscape space. They will use key spatial indicators such as proximity, shape, density, position, gradient, juxtaposition, and others in evaluating landscape-scale phenomena. The diverse cultural and biophysical landscapes of Minnesota will serve as the backdrop for developing and applying these principles. (Prerequisite(s): READ 0721 with a grade of "C" or better or appropriate assessment score) 3C/3/0/0

GISC 1775 Introduction to Remote Sensing

This course introduces students to fundamental and applied concepts in remote sensing. Students will be exposed to a detailed review of the electromagnetic spectrum, atmospheric windows, passive and active sensors, digital image processing techniques (including geometric and radiometric corrections), and image classification methods, among other topics. The ultimate goal of this course is to teach students to become adept at locating and properly processing remotely sensed data so that it is useful in a GIS computing environment while developing a good understanding of remote sensing theory and the limitations and strengths of remote sensing. 4C/4/0/0

GISC 1780 Spatial Analysis

This course introduces students to more rigorous GIS techniques for using customized spatial analyses to investigate and enhance digital spatial data in a GIS environment. The true power of GIS involves the ability to spatially adjust, extend, modify, and integrate digital spatial data (both rasters and vectors). The ultimate goal of this course is to teach students how to apply conceptual skills acquired in the spatial thinking course to digital spatial data in a GIS. Students will use

extensions (especially 3D Analyst and Spatial Analyst) and customized toolboxes in ESRI's ArcGIS suite of software to conduct the analyses. 3C/3/0/0

GISC 1785 GPS Field Techniques

This course introduces students to GPS field techniques used to map features out in the real world with hand-held GPS devices. Students will learn how to use Trimble GPS units to collect spatial data in the field while developing an appreciation for the theoretical underpinnings of global position systems and learning how to import and process data collected from the field. The ultimate goal of this course is to make students proficient at using hand-held GPS devices and to provide students an understanding of the strengths and weaknesses of GPS. 3C/3/0/0

GISC 2720 Web-Based GIS

This course introduces intermediate and advanced GIS students to concepts and techniques for integrating GIS with the Internet. Topics explored in the class will include various protocols, approaches, hardware, software, and programming languages utilized to serve digital spatial data via the Internet. Practical experience with Google Earth, KMUKMZ, Google Map APIs, Javascript APIs, Flex APIs, and ArcGIS Server will be used to teach and reinforce concepts. 3C/3/0/0

GISC 2725 Object-Based Image Analysis

This course introduces intermediate and advanced GIS students to the complexities of acquiring, processing, and extracting information from remotely sensed data with a high spatial resolution. Students will become familiar with applying object-based image analysis techniques on a data stack generated from LiDAR returns, QuickBird imagery, IKONOS imagery, aerial, and/or corresponding derivative data (e.g., vegetation indices, wetness indices, erosion indices, etc.). 3C/3/0/0

GISC 2730 Programming and Scripting in GIS

This course provides intermediate and advanced GIS students an introduction to the programming interface and function in ArcGIS. Fundamental concepts of computer programming are introduced from a geospatial processing perspective via the use of Python. General programming concepts will focus on object-oriented programming and scripting. Students will acquire basic programming skills and techniques necessary to search, explore, revise, manipulate, analyze, and model spatial data beyond the standard options available in the standard ArcGIS interface and extensions. 4C/4/0/0

Geography

GEOG 1700 Physical Geography

This course introduces students to natural landscapes and the geography of the physical environment. Topics include: volcanoes, earthquakes, tornadoes, hurricanes, landslides, glaciers, soil, the water cycle, etc. The course covers how these processes work, as well as how these systems and humans impact each other. So this course also covers environmental concerns such as destruction of environments, desertification, air pollution, climate change, etc. (Prerequisite(s): READ 0721 with a grade of "C" or better or appropriate assessment score) (MnTC: Goals 5 & 10) 3C/3/0/0

GEOG 1720 Human/Cultural Geography

This course covers the geographic study of the world cultural areas. Topics include: cultural geography (patterns of language and religion, folk customs, globalization, popular culture), political geography (formation of countries, conflict over land), populations (growth, distributions, migrations, characteristics), global economic activity, and development. Case studies from many parts of the world will be analyzed and key geographic concepts will be reviewed. (Prerequisite(s): READ 0721 with a grade of "C" or better or appropriate assessment score) (MnTC: Goals 5 & 8) 3C/3/0/0

GEOG 1740 World Geography

This course covers the geographic study of the world discussing U.S. and Canada, Latin America, Africa, Middle East, Europe, and various regions in Asia. Topics covered include: cultures and characteristics of regions, development, unique features around the world, movements of people around the world, the natural landscapes, economic influences, and conflict between countries. (Prerequisite(s): READ 0721 with a grade of "C" or better or appropriate assessment score) (MnTC: Goals 5 & 8) 3C/3/0/0

GEOG 1750 Minnesota Geography

In this course, students will explore Minnesota's regions. Topics covered include: people (culture, settlement patterns, and migrations), physical landscapes (glacial landforms, soils, and waterways), land use (agriculture, manufacturing, urbanization, etc.), geopolitical issues, and economics. (Prerequisite(s): READ 0721 with a grade of "C" or better or appropriate assessment score) (MnTC: Goals 5 & 10) 3C/3/0/0

GEOG 1790 Special Topics in Geography

This course is designed to present additional or unique material and learning experiences within a specified discipline. The course will be based on student need, flexibility, and may be designed to meet various transfer and pre-major course requirements. Please see a current Course Schedule for complete course details. (Prerequisite(s): READ 0721 with a grade of "C" or better or appropriate assessment score) (MnTC: Goal 5) Variable credits 1-6

Global Studies

GLOS 1710 Introduction to Global Studies

This interdisciplinary course introduces students to the concept of global studies and the processes of globalization. Students will examine the economic, political, cultural, and environmental aspects of globalization, with an emphasis on social change and conflict. Students will also discuss the effects of global cooperation, conflict, and interdependence on efforts to manage and mitigate global problems, both today and in the future. (Prerequisite(s): READ 0721 with a grade of "C" or better or appropriate assessment score. (MnTC Goals: 5 & 8) 3C/3/0/0

Global Trade

INTL 1400 Introduction to International Business

Introduces the student to the general field of international business. Study will cover foreign investments, cultural differences, impact of trade agreements, international payments, logistics, taxation and personnel issues. This course provides the foundation for other International Trade courses. 3C/3/0/0

INTL 1410 International Communications and Cultural Awareness

Covers potential problems in the international transaction due to language, and cultural differences. Both written and oral issues will be discussed. In addition, the areas of social and business habits that are different from one country to another will be covered. An understanding of these various needs will help ease the international transaction. 3C/3/0/0

INTL 1512 Export Shipping and Compliance

This course introduces students to the flow of merchandise in an international trade transaction, using various modes of transportation, routing, paperwork, regulations and Incoterms. The principle documents that must be prepared for shipments will be analyzed and created. Information will include the purpose of each document, its function, common problems in preparing and processing this type of document. Discussion will include reviewing documents from the banker, freight forwarder and shipper perspective. Export compliance issues will be discussed. 3C/3/0/0

INTL 2420 U.S. Customs and Importing

Provides students with the basic knowledge needed for customs clearance. This includes classification of products using the Harmonized System, understanding import regulations, marking rules, preparing entry documentation, learning various types of entries and special provisions. This course will help prepare the student to take the U.S. Customs Broker exam. Import compliance will also be discussed. 3C/3/0/0

INTL 2491 International Trade Internship

Cooperative work study program between the Saint Paul College International Trade Program and a business facility to allow the student an employment-like experience. Job duties must reflect program goals. (Prerequisite(s): Instructor approval) Variable lab credits 1-3

INTL 2497 International Trade Special Projects

The intent of this course is to allow flexibility in providing learning experiences to meet a special need of the student, the major program and the College. (Prerequisite(s): Instructor approval) Variable lab credits 1-3

INTL 2530 International Marketing

Study marketing from the international point of view. Topics include how and where to find new international customers, evaluating the needs of international customers, and keeping these customers happy while bringing a profit to the company. Also included are the fundamentals of selling, advertising, the effect of cultural differences on selling and advertising procedures, and techniques of closing the sale. 3C/3/0/0

Health

HLTH 1300 Behaviors for Success - Respecting Diversity

This course focuses on the exploration of healthcare careers and the requirements needed by health care personnel to effectively work in a variety of health care settings. Types of health care facilities and systems, applying for employment, accountability and responsibility, standards of dress, workplace behavior, approaches needed to assist individuals, expectations of teams and team members, common healthcare facility policies and requirements are explored. This course also provides a framework for dealing with diverse clients/individuals and staff. Included are belief systems, cultural practices, respect and sensitivity to cultural issues, gender issues and sexuality issues. Awareness and use of effective strategies to appropriately deal with client and staff diversity are emphasized.

HLTH 1310 Communication in Healthcare

This course emphasizes the importance of effective communication between and among healthcare employees and their clients/individuals. Included are verbal and non-verbal communication, listening skills, interpersonal communication, team communication, documentation and reporting, and the use of electronic communication devices in health care facilities. Focus is on the development of effective communication skills to support quality client/individual care.

HLTH 1320 Safety Precautions and Awareness of Client Needs

This course focuses on healthcare safety and standard precautions required of healthcare facilities as well as personal safety standards and requirements to work in healthcare settings. This course also presents challenges and issues related to awareness and sensitivity needed to understand the healthcare needs of clients/individuals.

HLTH 1410 Medical Terminology

Students recognize and build medical terms after learning the meaning of their component parts. A computer lab may be utilized to review terminology and provide practice in word building. (Prerequisite(s): READ 0722 with a grade of "C" or better or appropriate assessment score) 1C/0/1/0

HLTH 1418 Somatic Practitioner: Business and Ethics

In this course, students will be introduced to different types of business and ethical standards in the somatic industries of massage therapy, personal training, esthetics and wellness in the massage therapy industry, and basic aspects of a business plan. Topics include scope of practice, certifications, legal requirements, equipment options, charting, time management skills and payment tracking methods. Principles of professional ethics and interactions with clients are integrated throughout the course. (Prerequisite(s): Declared major in Massage Therapy or Sport and Exercise Sciences major) 2C/1/1/0

HLTH 1421 Anatomy & Physiology for the Somatic Practitioner

Assist the student to acquire basic knowledge of body structure and function with a more detailed exploration of musculo/skeletal, nervous and endocrine system. Students also recognize and build medical terms. Basic concepts of nutrition and understanding of the digestive system will be explored. A thorough understanding of the sliding filament theory and types of muscle contraction will be explored. (Prerequisite(s): Declared major in Massage Therapy, Sport and Exercise Sciences or Yoga program) 4C/2/2/0

HLTH 1422 Health & Wellness Coaching

The major focal points of this course is to coordinate knowledge of exercises, lifestyle and nutrition through thoughtful assessment and inquiry, collaborative problem-solving and goal-setting, and safe, open and honest dialogue to assist clients in obtaining future wellness results. Students will learn to help future clients by providing instruction and mentoring, assist in setting goals and help define an action plan that is holistic in nature. Emphasis will be on practical application of working with clients. (Prerequisite(s): Declared major in Massage Therapy or Personal Trainer program) 4C/2/2/0

HLTH 1425 Clinical Applications in Kinesiology

This is a course in the applied study of human movement. Students will study muscles of the body, origin and insertion sites, nerve innervation, associated bones and bony landmarks and action. Students will investigate planes of movement, types of joints, discuss directions and positions of the human body and perform basic structural assessment. Adhesions and trigger points will be discussed and palpated. This course will also look at the theory and practice of functional muscle testing. (Prerequisite(s): HLTH 1421. Physical ability to palpate the human body and willingness to view selected Human Cadaver videos are recommended.) 3C/1/2/0

HLTH 1432 CPR for the Professional Rescuer and Healthcare Provider

This American Red Cross course teaches CPR and AED use for those with a duty to respond. Course meets CPR requirements for Nurses, Nurse Assistants, and other allied health professionals. It is accepted for certification by the National Registry of Emergency Medical Technicians (NREMT). Skills are demonstrated for basic life support: solo and two-person CPR for the infant, child, and adult; the use of bad valve masks (BVM's); obstructed airway management; and training in Automatic External Defibrillators (AED's) for victims of sudden cardiac arrest. Certification is valid for two years. 1C/1/0/0

HLTH 1454 Yoga Postures/Asanas

A yoga practice can increase mental clarity, focus and support vitality in daily life. This course presents yoga principles and postures, called asanas, which develop balance, strength and flexibility. Students will learn the foundational yoga postures in each of the main categories of postures including: seated postures, standing postures, inversions, arm balances, hip openers and twists. Students will study an overview of the health benefits gained through yoga practice. Discuss health limitations with the instructor. (Prerequisite(s): Must have at least six months regular yoga practice experience prior to attending this training) 3C/2/1/0

HLTH 1458 Relaxation and Meditation

Learn relaxation techniques and study the many benefits of meditation. Students learn various mindfulness practices including guided relaxation, gentle yoga, breathing techniques, walking meditation, and sitting meditation. Students will develop a consistent routine and learn techniques to help cope with stress and cultivate a deeper awareness of themselves and how they relate to the world. 3C/2/1/0

HLTH 1459 Yoga Asanas/Teaching Methodology

Deepen your understanding of the yoga asanas (postures). Students will study the yoga postures in each of the main categories of postures, seated postures, standing postures, inversions, arm balances, hip openers and twists. Refine your understanding and skills of alignment within asanas. Teaching methodology includes alignment, sequencing, adjustments and effective ways to guide students in a yoga practice. Discuss the business aspects of teaching yoga. (Prerequisite(s): HLTH 1454. Discuss health limitations with the instructor.) 3C/2/1/0

HLTH 1465 Functional Holistic Nutrition

The focus of this class is to develop a solid awareness of nutrition; be able to utilize that awareness and make suggestions to somatic practitioner clientele in a legal and ethical fashion, as outlined by the National Association of Nutrition Professionals (NANP) associate membership. 4C/3/1/0

HLTH 1485 Therapeutic Exercise

The focus of this course is the management of common, soft-tissue injuries through inhibitory techniques, bracing, taping, advanced stretching and corrective exercise techniques. Adaptive exercise for special populations such as geriatrics and pregnancy will also be discussed. (Prerequisite(s): HLTH 1425 recommended) 5C/0/5/0

HLTH 1541 Yoga History/Philosophy

This course will provide a solid foundation in the historical and philosophical concepts of yoga. Study historical texts such as the Bhagavad Gita and Patanjali's Yoga Sutras that provide lessons and offer clear steps on the path of yoga. Learn philosophical concepts of various schools of yoga including: Tantra, Ayurveda, chakras, and more. 3C/2/1/0

HLTH 1570 Trained Medication Aide

This program provides an overview of the requirements concerning medications and their administration. Other topics include legal criteria, medical abbreviations, medical math and basic dosage calculations, use of the Physician's Desk Reference (PDR) along with current medication handbooks. A basic overview of body systems and drug classifications are included. Administration of medications via oral, eye, ear, rectal, topical and inhalant routes will also be covered. Attendance of all classes is mandatory; any absence will may result in repeating the course. Students must attain 90% on all examinations to continue in the class. 2C/1/1/0

HLTH 1575 EKG & Telemetry

This comprehensive 6 credit course will prepare students to be an EKG Technician and take the Certified EKG Technician (CET) exam. An EKG Technician attaches electrodes to the patient's body which then send a signal to a machine displaying the activity in a recognized pattern. The technician will recognize abnormalities in EKG tracings and report them to a physician or other authorized healthcare providers for interpretation. Students will study: cardiac anatomy and physiology, EKG equipment (attaching to patients, proper safety and operation, recognize artifacts and resolve problems), how to recognize tracings that deviate from normal and prioritize reporting of such deviations, heart rhythms and wave forms, obtain basic vitals, HIPAA compliance, use of Holter monitors, introduction to stress tests and 12-lead EKGs. (Prerequisite(s): HLTH 1432 Basic Life Support (BLS) for Healthcare Providers). 6C/4/2/0

HLTH 1580 Medical Office Skills for the Patient Care Technician

The Medical Office Skills Technician course provides the student with the administrative skills necessary for being a Patient Care Technician. The course provides the student with the administrative skills necessary for being a Patient Care Technician. The course consists of topics such as electronic health records, documentation, patient records, insurance, and medical coding as they apply to inpatient and outpatient settings. (Pre-requisite(s): HLTH 1410) 3C/3/0/0

HLTH 1585 Job Readiness Certification Exam Preparation

The Job Readiness/Certification Exam Preparation course prepares students for their career as a Patient Care Technician and for the certification exam. Students will develop cover letters, resumes, and interview skills. Study skills for the certification exam review will also be covered. A SAMPLE certification exam will be administered in this course as well. This course is for Patient Care Technician students in their last semester of coursework. 2C/2/0/0

HLTH 1610 Sport and Exercise Coaching

This course introduces the student to the major components of fitness analysis, basic exercise program design, and the skills necessary for teaching individual activities. Components of exercise physiology are included throughout. Must earn a grade of “C” or better to proceed. (Prerequisite(s): Must be enrolled in Sport and exercise Sciences program.) 5C/3/2/0

HLTH 1620 Advanced Concepts in Training

This course explores advanced components of fitness analysis, functional training program design, and the skills necessary for teaching group activities. Components of exercise physiology are included throughout. (Prerequisite(s): HLTH 1610 with a grade of “C” or better) 5C/3/2/0

HLTH 1630 Functional Exercise Physiology

The emphasis of this class is to prepare Personal Trainers to be Metabolic Testing Specialists. Exploration of the effects of various types of exercise on body systems complete with testing protocols will be performed. VO₂ max test, power tests, plyometric tests, Lactate testing, body fat testing, and speed testing will be performed. Progressions based on testing outcomes will be created. (Prerequisite(s): HLTH 1610 with a grade of “C” or better) 3C/1/2/0

HLTH 1690 Sport and Exercise Sciences Internship

This course is the final component of the personal trainer curriculum that serves to integrate all materials learned in a practical setting. Students will be placed at various training facilities providing direct application of personal training techniques and methodologies. Must earn a grade of “C” or better in this course. (Prerequisite(s): Instructor approval) 5C/0/5/0

HLTH 1900 Pathology for the Somatic Practitioner

This course is designed to teach the study of deviations from normal anatomy and physiology as well as basic pharmacology. Students will examine injury and disease related conditions most likely to be encountered in a somatic practice. Special attention is given to signs and symptoms, indications and contraindications of treatment methods, as well as instruction related to skin, neuromuscular and soft tissue conditions. Basic pharmacology will be examined along with drug/ supplement interactions. (Recommendation(s): HLTH 1421) 4C/3/1/0

History

HIST 1730 Contemporary World History

This course surveys Contemporary World History, from the end of World War II to the present with a focus on Europe, Asia, Africa, Latin America and the Middle East. Significant forces, ideas, events and people that have influenced the world since 1945 are studied. Course themes highlight how and why events transpired and created

change in people’s lives. Historical events are studied to provide an appreciation for their influence on contemporary society and the implications they may hold for the future. (Prerequisite(s): READ 0721 with a grade of “C” or better or concurrent enrollment or appropriate assessment score.) (MnTC: Goals 5 & 8) 3C/3/0/0

HIST 1745 U.S. History to 1877

This course surveys the political and social history of America from the seventeenth century to the end of the Civil War. The interaction of Europeans, Native Americans, and Africans through the Colonial Era, the American Revolution, and the Early Republic will be discussed. Topics covered also include Jacksonian Democracy, westward expansion, the role of women in the nineteenth century, nineteenth century immigration, and the controversy over slavery. (Prerequisite(s): READ 0721 with a grade of “C” or better or concurrent enrollment or appropriate assessment score.) (MnTC: Goals 5 & 7) 4C/4/0/0

HIST 1746 U.S. History Since 1877

This course surveys the political and social history of America from the end of the Civil War to the present. Topics covered include Reconstruction and racial segregation in the South, the Gilded Age and Progressive Era, the Great Depression of the 1930s, World Wars I and II, the war in Vietnam, the Civil Rights Movement, and social movements of the 1960s. Throughout the course the roles of women, immigrants, and people of color will be discussed. (Prerequisite(s): READ 0721 with a grade of “C” or better or concurrent enrollment or appropriate assessment score.) (MnTC: Goals 5 & 7) 4C/4/0/0

HIST 1750 Minnesota History

This course surveys Minnesota’s historical development from the pre-Columbian period to the present. It focuses on the historic importance of Minnesota’s geography and natural resources, American Indian-white relations, the development of Minnesota’s unique political tradition and the emergence of Minnesota’s diverse society and economy. Course readings, videos and class discussions are supplemented by visits to metro-area historic sites and the Minnesota Historical Society’s History Center. In addition, students are exposed to the tools and techniques historians use to study the past as a part of completing research projects. (Prerequisite(s): READ 0721 with a grade of “C” or better or concurrent enrollment or appropriate assessment score.) (MnTC: Goals 5 & 10) 3C/3/0/0

HIST 1760 History of World Civilizations to 1500

This course surveys world history from the first civilizations to 1500 C.E. Course themes focus on political, ideological, economic, social, cultural, religious, technological and environmental developments in Africa, Eurasia and the Americas. (Prerequisite(s): READ 0721 with a grade of “C” or better or concurrent enrollment or appropriate assessment score.) (MnTC: Goals 5 & 8) 3C/3/0/0

HIST 1761 History of World Civilizations since 1500

This course surveys world history from 1500 C.E. to the present. Course themes focus on political, ideological, economic, social, cultural, religious, technological and environmental developments in Africa, Eurasia and the Americas. Special focus is given to global factors that allowed the West to exercise significant influence over the development of Africa, Asia and the Americas. (Prerequisite(s): READ 0721 with a grade of “C” or better or concurrent enrollment or appropriate assessment score.) (MnTC: Goals 5 & 8) 3C/3/0/0

HIST 1770 History of Women in the United States

This course explores the history of women in the United States from the colonial period to the present. Within this chronological framework, the course examines how women understood their lives as individuals and as members of families and communities. The course also explores strategies through which women of diverse races, classes, and ethnicities struggled to control their own lives and identities. Special focus is given to how ideologies of gender, race, class and sexuality framed American society and culture.

(Prerequisite(s): READ 0721 with a grade of “C” or better or concurrent enrollment or appropriate assessment score.) (MnTC: Goals 5 & 9) 3C/3/0/0

HIST 1773 African American History

This course explores the history of African American men and women in the United States from their involuntary arrival in the early 17th century to the present. Within this chronological framework, the course will examine the historical changes that have shaped African American life and culture, explore how African Americans have understood their lives as individuals and as members of families, communities and institutions, evaluate how ideas about race and color have framed the societies in which Americans lived, and examine the struggle of African Americans to gain freedom, full citizenship, civil rights, and equality. (Prerequisite(s): Grade of “C” or better in READ 0721 or appropriate assessment score) (MnTC: Goals 5 & 7) 3C/3/0/0

HIST 2740 Immigration and Ethnic History of the United States

This course surveys the experiences of immigrant groups and ethnic minorities within the United States from the colonial period to the present. The experiences of American Indians and immigrant groups from Europe, Africa, Asia and Latin America are explored and their contributions to a multi-cultural America are discussed. Additional course themes include: slavery and its legacies, US government American Indian policy and US government immigration policy. (Prerequisite(s): READ 0721 with a grade of “C” or better or concurrent enrollment or appropriate assessment score.) (MnTC: Goals 5 & 9) 3C/3/0/0

HIST 2780 Special Topics in History

This course is designed to present additional or unique material and learning experiences within a specified discipline. The course will be based on student need, flexibility, and may be designed to meet various transfer and pre-major course requirements. Please see a current Course Schedule for complete course details. (Prerequisite(s): READ 0721 with a grade of “C” or better or concurrent enrollment or appropriate assessment score.) (MnTC: Goals 5 & 7) Variable credits 1-6

HIST 2790 Historical Methods

This course is a capstone experience intended for students pursuing an AA degree with an emphasis in history. Students will arrange this course with a history instructor and, along with the instructor, tailor their course to their interests and/or intended future area of study. Students will be exposed to the profession’s methodology and produce a research-based semester-long capstone project. (Prerequisite(s): Instructor approval) (MnTC: Goals 5 & 7) 2C/2/0/0

Hospitality Management

HSPM 1410 Introduction to Hospitality Management

This course provides an orientation to the hospitality industry. This includes an introduction to the structure of lodging, food service and tourism organizations, the role of lodging departments, the future of the industry and career opportunities. Course structure includes lecture, projects, discussion and guest speakers. 3C/3/0/0

HSPM 1440 Event Management and Planning

This course will provide an overview of Event Management. Topics include identifying the purpose of special events, planning timelines, organization, managing volunteers, evaluation, invitations and logistics. Emphasis will be placed on the principles of management and marketing and how they apply in event planning. Career opportunities in event planning will also be explored. 3C/3/0/0

HSPM 2420 Hotel and Lodging Operations

This course provides students the key principles in the lodging industry, focusing on strategic planning as the foundation for operation effectiveness. 3C/3/0/0

HSPM 2440 Hospitality Marketing and Sales

This course provides principles and practices of marketing the services of the hospitality industry. Emphasis includes the marketing concept with applications leading to customer satisfaction. 3C/3/0/0

HSPM 2591 Hospitality, Management Internship

This course provides students the hands-on opportunity to work in the hospitality industry. (Prerequisite(s): Advisor approval) Variable credits 1-3

Human Resources

HMRS 1400 Human Resource Management

An introduction to the basic principles of Human Resource functions and services. It will provide background and understanding for further Human Resources courses in the Human Resource Program. 3C/3/0/0

HMRS 1490 Talent Management

This course provides students with a basic understanding of the employment and staffing functions in an organization. Attention will be devoted to the recruitment process, effective interviewing, applicant evaluation techniques, legal requirements, reference checking, and new employee orientation. This course also covers basic information about the training and development functions in an organization and its role in building an effective workforce. Students study effective training techniques including needs assessments, transfer of training, training evaluation, training methods, technology in training, and employee development issues. 3C/3/0/0

HMRS 1510 Human Resources Information Systems and Records

Covers basic information on, and an understanding of, types of Human Resource records, employers’ information needs, and government recordkeeping/reporting needs. It also includes an introduction to various HRIS software programs, with hands-on applications. 3C/2/1/0

HMRS 1520 Compensation and Benefits Administration

Covers basic information about various types of benefits that are typically offered by employers. The course covers mandatory government benefits and voluntary benefits. Also included is information about employee compensation and related federal laws. 3C/3/0/0

HMRS 2410 Employee/Labor Relations

This course focuses on employee relations techniques such as: coaching, mentoring, performance management, employee discipline, workplace violence prevention, employee crisis management and effective communication, including gender and generational communication in the workplace. Also covered are the labor relations issues that supervisors need to deal with on a daily basis when working in a union environment. 3C/3/0/0

HMRS 2420 Employment Law and HR Policies

Provides students with an understanding of EEO legislation and other federal laws relating to employment and the impact of these laws on an organization. Students will also study the emerging legal issues facing today’s Human Resource Departments. The course will also define the needs for HR policies and the development of a variety of policies. 3C/3/0/0

HMRS 2591 Human Resource Internship

Designed to provide the student with a purposeful, occupational experience in the Human Resource field. Each internship is an individualized experience. A training plan is created for each student, in conjunction with the training site, to provide experience related to the skills and knowledge acquired in the program. (Prerequisite(s): Advisor approval) Variable credits 3–6

Humanities

HUMA 1720 The Ancient and Medieval World

This course introduces students to the global humanities and shows the relationship between cultures of the past and life in the present. The course includes an examination of written works, art, architecture, and religion from Greece, Rome, the Middle Ages and the Renaissance, and other cultures. Texts, materials and interdisciplinary assignments will examine the arts and ideas of the West in relation to those of other world cultures, including India, East Asia, Africa and Native America. (Prerequisite(s): READ 0722 with a grade of “C” or better or appropriate assessment score) (MnTC: Goals 6 & 8) 4C/4/0/0

HUMA 1730 The Modern World

This course introduces students to the global humanities and shows the relationship between the culture of the past and life in the present. The course includes an examination of written works, art, architecture and music from the Modern World (roughly the 16th century to the present). Texts, materials and interdisciplinary assignments will examine the arts and ideas of the West in relation to those of other world cultures, including India, East Asia, Africa and Native America. (Prerequisite(s): READ 0722 with a grade of “C” or better or appropriate assessment score) (MnTC: Goals 6 & 8) 4C/4/0/0

HUMA 1750 Culture and Civilization: Spanish-Speaking Cultures

Taught in English, this course introduces students to the mosaic of qualities that make up the culture and civilization of Spanish-speaking people of the Americas, Spain and elsewhere across the globe. To provide students with an awareness of the cultural, social, religious and linguistic values of Spanish speaking cultures, multi-media resources (Internet, music, video) will be used to illustrate course topics, including the arts, literature and history. This course may include guest speakers and visits to local Latino/Hispanic cultural centers. (Prerequisite(s): READ 0722 with a grade of “C” or better or appropriate assessment score) (MnTC: Goals 6 & 8) 3C/3/0/0

HUMA 1770 The Art of Film

This course is an introduction to film as an art form and as a medium for portraying ideas, myths, human concerns and aesthetic principles. The course includes an examination of film techniques, film theories and artistic styles of films such as formalism, surrealism, expressionism and neorealism. (Prerequisite(s): READ 0722 with a grade of “C” or better or appropriate assessment score) (MnTC: Goal 6) 3C/3/0/0

HUMA 1780 American Film

This course presents an introduction to American film history, including several representative genres and filmmakers. We consider film as art form, business, and as a medium of cultural communication. Course content is designed to encourage students to question their role as passive spectators and to develop students' abilities to communicate effectively about film by joining observation with critical thinking skills such as description, interpretation, comparison, and analysis. (Prerequisite(s): READ 0722 with a grade of “C” or better or appropriate assessment score) (MnTC: Goals 6 & 7) 3C/3/0/0

HUMA 1790 International Film

A study of film as an art form and as a means of cultural communication from an international perspective. The course is designed to cultivate an ability to engage with film in a critical way, as well as broaden understanding of film and culture in a global context. Each semester a variety of national cinematic traditions will be examined including films from Europe, Japan, India, China, Africa, and Latin America. (Prerequisite(s): READ 0722 with a grade of “C” or better or appropriate assessment score) (MnTC: Goals 6 & 8) 3C/3/0/0

HUMA 1795 Special Topics in Humanities

This course is designed to present additional or unique material and learning experiences within a specified discipline. The course will be based on student need, flexibility, and may be designed to meet various transfer and pre-major course requirements. Please see a current Course Schedule for complete course details. (Prerequisite(s): READ 0722 with a grade of “C” or better or appropriate assessment score) (MnTC: Goal 6) Variable credits 1-6

Individualized Studies

INDS 1401 Study Skills and Strategies for Individualized Studies and Planning

This course is designed to help students identify and develop necessary skills and strategies to enhance study skills and college success. This course covers the development of the individualized studies degree plan. Upon completion of the course, students will have a completed individualized studies plan which meets their career and employment goals. Focused topics will include college expectations; overcoming barriers to success; study skills such as time management and note-taking; learning styles; college resources; and maintaining physical, mental, and emotional health. 3C/3/0/0

Interpreter/Transliterater Sign Language

INTP 1440 Orientation to Interpreting

This course introduces students to the profession of sign language interpreting. It covers the history of interpreting as a field of professional practice, the required professional ethical and performance standards, the impact of legislation on the field, the phenomena of cross cultural dynamics, oppression of minority groups and the role of an interpreter as a cultural mediator. (Prerequisite(s): INTP 1500 Interpreting Process with a grade of “C” or better) 3C/3/0/0

INTP 1442 English Grammar for Sign Language Interpreters

This course covers fundamentals of English grammar and writing and their relationship to the study of ASL and interpreting/transliterating. Topics include: parts of speech; prepositional phrases; simple, perfect, and progressive verb tenses; passive and active voice sentences; direct and indirect objects; predicate adjectives, predicate nouns, and predicate pronouns; fundamentals of English sentence structure; punctuation; capitalization; proofreading strategies; and grammatical aspects of English that create challenges for interpreters/transliterators. The course provides terminology and skill-building exercises which will enable students to: more clearly talk about and analyze aspects of English and ASL; more accurately evaluate their interpreting/transliterating work; identify non-standard English; and evaluate and develop their use of spoken and written standard English. (Prerequisite(s): Completion of ASLS 1413 American Sign Language 3 with a grade of “C” or better) 2C/2/0/0

INTP 1465 Special Topics

A variable credit granting course in the area of interpreting/transliterating, American Sign Language, specific sign forms, linguistic skills, Deaf Culture or a related area, that is designed to meet the needs of specific groups of students. Each course is designed and accepted based on a written syllabus outlining the objectives and procedures for delivery. Variable credits 1-5

INTP 1500 Interpreting Process

This course introduces students to the theory and application of the interpreting process. Application of interpreting process skills occurs through consecutive interpretation. The goal of the course is to develop cognitive processing skills involved in the interpreting process. (Prerequisite(s): Acceptance into the Sign Language Interpreter/ Transliterater Program and ASLS 1420 ASL Linguistics and/or INTP 1442 English Grammar for Sign Language Interpreters with a grade of “C” or better or taken concurrently with ASLS 1420

ASL Linguistics and INTP 1442 English Grammar for Sign Language Interpreters. It is necessary for students in the Sign Language Interpreter/Transliterator Program to be able to process auditory and visual information.) 2C/2/0/0

INTP 1512 Consecutive Interpreting 1

This course develops consecutive interpreting skills introduced in INTP 1500 and prepares students for the simultaneous interpreting process. Students compare American Sign Language and English semantic/ syntactic structures to the consecutive interpreting process. Focus in this course will be on text translation, vocabulary expansion and interpreting process skill development. (Prerequisite(s): Grade of “C” or better in ASLS 1420 and INTP 1500) 4C/2/2/0

INTP 1513 Consecutive Interpreting 2

This course builds upon Consecutive Interpreting skills to prepare students for the simultaneous interpreting process. Students will analyze and compare more complex American Sign Language and English texts in order to prepare for the simultaneous interpreting task. (Prerequisite(s): Grade of “C” or better in ASLS 1430 and INTP 1512) 2C/2/0/0

INTP 2410 Video Relay Interpreting/ Video Remote Interpreting

This course introduces students to Video Remote Interpreting and Video Relay Interpreting. It consists of the history of VRI and VRS as a field of professional practice. It covers the call opening, middle and closing, call management, special populations, cultural considerations, register, affect, current technology, ethical considerations, federal and state governing rules, and similarities and differences between VRI and VRS. Vicarious trauma, self-care, and team interpreting topics will be included. Practical application will be made through real-time phone calls. Course content is at an intermediate to advanced level of complexity. (Prerequisite(s): INTP 2592 Interpreter Internship with a grade of “C” or better) 2C/1/1/0

INTP 2411 Sign to Voice Interpreting 1

Focuses on the process of interpretation, provides practice of requisite skills and process tasks and applies skills and theory to the translation process. The course of study focuses on lexical development, syntactical language comparisons, voice production techniques, text/discourse/ interpreting process analysis, semantic mapping and diagnostic assessment. (Prerequisite(s): INTP 1513 with a “C” or better) 4C/1/3/0

INTP 2412 Sign to Voice Interpreting 2

Provides students with additional practice in specific skill areas related to sign-to-voice interpretation. Text/discourse/process analysis, lexical and syntactic development, voice production techniques for simultaneous sign-to-voice interpretation will be the focus. Course content is at an intermediate to advanced level of speed and complexity. Students will work primarily from videotaped language models. (Prerequisite(s): INTP 2411 with a grade of “C” or better) 2C/1/1/0

INTP 2421 Voice to Sign Interpreting 1

Provides students techniques for translating the source language English to the target language American Sign Language (ASL) in simultaneous manner. (Prerequisite(s): Grade of “C” or better in INTP 1513) 4C/1/3/0

INTP 2422 Voice to Sign Interpreting 2

This course allows students to continue practicing rendering the target language (ASL) from the source language (English) simultaneously. It also provides preparation for Internship. Continued emphasis and focus is on appropriate uses of lexical and syntactic principles and non-manual behaviors of ASL. (Prerequisite(s): Completion of INTP 2421 with grade of “C” or better) 2C/1/1/0

INTP 2431 Transliterating 1

This course covers the process of Transliteration (changing a message expressed in spoken English into a coded form of the language). The process moves along a continuum from Contact Language to a signed form of English. Specific subtasks are isolated in order to focus on transliterating skill development, enhancing component skills and incorporating ASL features. These skills are integrated into the performance of beginning to intermediate tasks. (Prerequisite(s): Grade of “C” or better in INTP 1513) 4C/1/3/0

INTP 2432 Transliterating 2

This course expands the process of visually representing English. Students will focus on the expansion and enhancement of transliterating skills at the English end of the ASL-English continuum. Students will incorporate ASL features into intermediate to advanced level texts presented in a simultaneous mode. (Prerequisite(s): Grade of “C” or better in INTP 2431) 2C/1/1/0

INTP 2450 Deaf/Blind Interpreting

Provides students with a working knowledge of the requirements, skills and communication techniques needed to interact and/or interpret with consumers who are Deaf/Blind. (Prerequisite(s): INTP 2411, INTP 2421, INTP 2431) 2C/2/0/0

INTP 2585 Internship Orientation

This course introduces students to the requirements, guidelines, professional practices and types of placements for field experience. Students will discuss protocol, skills, ethics and business practices needed for specific site placements. (Prerequisite(s): Grade of “C” or better in INTP 1513) 1C/1/0/0

INTP 2592 Interpreter Internship

This course is a career-related, supervised work experience that integrates classroom theory and skills with real-life experiences; further develops skills and abilities initiated in program coursework; develops mentoring relationships and skills; identifies resources; expands application of ethical decision making and problem-solving; and prepares students for national certification and employment. (Internship Eligibility: Grade of “C” or better in INTP 2411, 2421, and 2431. Internship Placement: Grade of “C” or better in Interactive Performance Skills Evaluations in INTP 2412 Sign to Voice 2, INTP 2422 Voice to Sign 2 and INTP 2432 Transliterating 2) 5C/0/0/5

Massage Therapy

MASS 1400 Introduction to Therapeutic Massage

This course will enable the student to track the history and development of massage therapy, understand the scope of practice, body mechanics for the practitioner, contraindications for therapy and professional ethics for practitioners. Students will review massage-specific anatomy and physiology with emphasis on muscle identification, actions and insertions on the skeleton. Students will be introduced to basic massage techniques through demonstration and practice. Students will practice correct table set-up and sanitation. Must earn a grade of “C” or better to proceed. (Prerequisite(s): Declared Massage Therapy major) 4C/2/2/0

MASS 1421 Massage Spa Techniques

Students will refine previously learned techniques from the MASS 1400 course. Advanced techniques in chair massage, hydrotherapy, stone therapy, lymphatic drainage massage, reflexology, aromatherapy, pregnancy massage and body wraps will be introduced. Students will learn to integrate various spa techniques in a single massage session. Must earn a grade of “C” or better in this course. (Prerequisite(s): MASS 1400 with a grade of “C” or better) 2C/0/2/0

MASS 1422 Massage Clinical Techniques

Students will refine previously learned techniques in Swedish massage and deep-tissue massage by demonstrating mastery of massage therapy contraindications, body mechanics, muscle actions and insertions. Students will learn stretches for both client and self-care. Advanced techniques in chair massage, reflexology, myofascial release, lymph drainage and neuromuscular therapy will be introduced. Must earn a grade of “C” or better in this course. (Prerequisite(s): MASS 1400 with a grade of “C” or better) 4C/2/2/0

MASS 1423 Advanced Clinical Sports Massage Techniques

Students will refine previously learned techniques. Students will investigate various treatment protocols utilizing scientifically proven, outcome-based techniques including Neuromuscular Therapy, Manual Lymphatic Drainage, Myofascial Release, Travel Trigger Point Therapy, Muscle Energy Technique, Proprioceptive Neuromuscular Facilitated Stretching, Active Isolative Stretching and Positional Release Technique. Students will learn to perform thorough patient assessments utilizing medical histories and objective findings through palpation, functional muscle testing, range of motion testing, postural examination and gait examination. Students will learn to create a care-plan based on evaluations; create treatment plans using carefully selected techniques for the given pathology; and learn to recommend exercises to the patient. Students will learn to give supplementary care as prescribed by a licensed Physician, Chiropractor or Physical Therapist for pathologies including multiple sclerosis, spinal cord injury, traumatic brain injury, stroke, diabetes, AIDS, cancer, burns, post-surgical scarring, chronic pain and fibromyalgia. (Prerequisite(s): Certificate in Massage Therapy or equivalent as evaluated by faculty) 5C/2/3/0

MASS 1480 Massage Therapy Practicum

This course meets the requirement of the performance and documentation of the minimum 50 full-body sessions. Students will demonstrate and apply all previously learned techniques including use of client intake information, knowledge of massage therapy contraindications and skills in charting for each client. Must earn a grade of “C” or better in this course. (Prerequisite(s): MASS 1400 and MASS 1422 with a grade of “C”) 4C/0/0/4

MASS 1490 Clinical Massage Internship

Students will refine all previously learned techniques and put them into practice. Students are placed in a traditional clinical setting at Chiropractic offices, Medical Sport Institutes and Physical Therapy clinics for half of the internship. For the second half students may choose to focus on an area of choice such as oncology, pre and post natal, geriatric, AIDS, infant massage, or orthopedic settings. Must earn a grade of “C” or better in this course. (Prerequisite(s): MASS 1423 (with a grade of “C” or better), Instructor approval or completion of entire clinical massage curriculum and professional membership with ABMP including liability insurance. Students must have current CPR certificate and liability insurance on file at Saint Paul College before starting internship.) 5C/0/0/5

Mathematics

MATH 0910 Introductory Algebra

This course is intended for students who need to master the fundamentals of algebra. The topics include a review of the real number system, solving equations and inequalities, and their applications, graphing linear equations, solving systems of linear equations, exponents, polynomials and quadratic equation solving and applications. (Prerequisite(s): Appropriate assessment score) 3C/3/0/0

MATH 0920 Intermediate Algebra

This course is intended for students who have had one year of high school algebra and need a refresher before taking courses such as College Algebra and/or Pre-Calculus. The topics include a review of

solving equations and inequalities and their applications, exponents and polynomials, factoring polynomials, solving quadratic equations and their applications, rational expressions, rational exponents and radicals, and graphing functions (linear and quadratic). Students wanting to take Calculus will have the option of taking either Pre-Calculus or both College Algebra and Trigonometry as their prerequisites. (Prerequisite(s): Grade of “C” or better in MATH 0910, or appropriate assessment score) 3C/3/0/0

MATH 1411 Applied Mathematics

This course is required for students in certain trade programs. It is designed to help students develop the numerical skills needed to perform tasks in their trade. Topics include whole numbers, fractions, decimals, percents, ratios and proportions, powers, roots, integers, polynomials, equations, plane and solid geometry, trigonometric functions, and word problems relevant to the trades. (Placement into this course will be according to college assessment score.) 3C/2/1/0

MATH 1420 Trade Algebra and Trigonometry

This course is intended for the student who needs to master the fundamentals of algebra and right triangle trigonometry as they apply to the construction trades. The content of this course includes a review of basic math, simplifying expressions involving constants and variables, solving algebraic equations, solving literal problems using spreadsheets and graphing calculators and solving construction trade problems with algebra and right triangle trigonometry. (Placement into this course will be according to college assessment score.) 3C/3/0/0

MATH 1710 Liberal Arts Mathematics

This class includes selected topics from the mathematics of social choice, growth and symmetry, and probability and statistics. Real-life applications are used to illustrate mathematical concepts. Modern discoveries, as well as classic problems, are described using straightforward examples. A fundamental objective is to develop an appreciation for the aesthetic elements of mathematics. The development of critical thinking skills through the application of mathematics is also emphasized. This course is designed for students who are not planning to take any further mathematics courses. This course can be used to satisfy the general education requirement for math. (Prerequisite(s): MATH 0910 Introductory Algebra with a grade of “C” or better or appropriate assessment score) (MnTC: Goal 4) 3C/3/0/0

MATH 1730 College Algebra

This course covers algebraic functions and their applications. Topics include linear and quadratic functions, functions and graphs, polynomial and rational functions, exponential and logarithmic functions, systems of equations and inequalities, matrix algebra, discrete algebra, the binomial theorem and probability. Graphing calculators are used to further the student’s understanding of essential mathematical concepts. Students wanting to take Calculus will have the option of taking either Pre-Calculus or both College Algebra and Trigonometry as their prerequisites. (Prerequisite(s): MATH 0920 with a grade of “C” or better, or appropriate assessment score) (MnTC: Goal 4) 3C/3/0/0

MATH 1740 Introduction to Statistics

This course covers concepts and applications of descriptive and inferential statistics. Measures of central tendency and variance, confidence intervals, normal distributions and central limit theorem are explored. The student learns about probability distributions and random variables. Techniques of estimation, hypothesis testing, z-scores, t-tests, F-tests, Chi-square tests, analysis of variance (ANOVA) and linear regression are covered in this course. This course can be used to fulfill the general education requirement for math, and transfer to 2 and 4 year institutions. (Prerequisite(s): MATH 0920 Intermediate Algebra with a grade of “C” or better or appropriate assessment score) (MnTC: Goal 4) 4C/4/0/0

MATH 1750 Trigonometry

This course introduces trigonometric functions and their applications. Topics in trigonometry include angles and the unit circle, graphs of functions, equations, identities, triangles, and the Laws of Sines and Cosines. Vectors, polar coordinates, and parametric equations will also be explored. A review of the fundamentals of functions will be included at the beginning of the course. Students wanting to take Calculus will have the option of taking either Pre-calculus or both College Algebra and Trigonometry as their prerequisites. (Prerequisite(s): MATH 1730 College Algebra with a grade of "C" or better, or appropriate assessment score) (MnTC: Goal 4) 3C/3/0/0

MATH 1762 Pre-Calculus

Pre-Calculus is often described as an accelerated version of College Algebra and Trigonometry. This course introduces algebraic and trigonometric functions and their applications. Topics include polynomial, rational, exponential, logarithmic functions, sequences, series, and limits. Vectors, parametric equations, and analytic geometry will also be explored. In addition, this course covers trigonometric functions, identities and equations and the laws of sines and cosines. (Prerequisite(s): MATH 0920 Intermediate Algebra with a grade of "C" or better, or MATH 1730 College Algebra with a grade of "C" or better, or appropriate assessment score) (MnTC: Goal 4) 5C/5/0/0

MATH 1790 Special Topics in Mathematics

This course is designed to present additional or unique material and learning experiences within a specified discipline. The course will be based on student need, flexibility, and may be designed to meet various transfer and pre-major course requirements. Please see a current Course Schedule for complete course details. (MnTC: Goal 4) Variable credits 1-6

MATH 2100 Intermediate Statistics

Second course in statistics provides an approach to statistical practices including nonparametric methods, simple regression, multiple regression, logistic regression, log-linear regression, ANOVA and survival, component and Bayesian data analysis. Application and interpretation of computer output will be highlighted. This course should be useful to students who are interested in learning natural sciences, economics, finance and data science. This course can be used to fulfill the general education requirement for math, and transfer to 2 and 4 year institutions. (Prerequisite(s): MATH 1740 Introduction to Statistics with a grade of "C" or better) (MnTC: Goal 4) 4C/4/0/0

MATH 2460 Discrete Structures of Computer Science

This is a course in discrete mathematical structures to prepare students for advanced courses. Topics include set theory, functions and relations, the big O notation, logic, truth tables and Boolean expressions, proof techniques including mathematical induction, and tree/graph fundamentals. Credit will not be awarded for both MATH 2460 and CSCI 2460. (Prerequisite(s): CSCI 1410 and MATH 1730 or higher) 4C/4/0/0

MATH 2749 Calculus 1

This course is a beginning calculus course, which introduces the concepts of limits, derivative, differentiation and integration of functions with emphasis on applications. Topics include introduction to the derivatives and limits, tangent to a curve, properties of limits, derivative of a real function, the power rule and the algebra of derivatives, the chain rules, the mean value theorem, applications of differentiation including max-min problems and related rate problems, anti-derivatives and the definite integral. Graphing calculators are used to further the student's understanding of essential concepts. (Prerequisite(s): MATH 1750 Trigonometry or MATH 1762 Pre-Calculus with a grade of "C" or better, or appropriate assessment score) (MnTC: Goal 4) 4C/4/0/0

MATH 2750 Calculus 2

This course is a continuation of MATH 2749 Calculus 1 and the continued development of the properties and applications of integration. Topics include applications of integral, transcendental functions, techniques of integration sequences and series and

parametric equations and polar coordinates. A graphing calculator is required. Upon completion of Calculus 2, students can take either MATH 2753 or MATH 2760. (Prerequisite(s): A grade of "C" or better in MATH 2749) (MnTC: Goal 4) 4C/4/0/0

MATH 2753 Multivariable Calculus

This course is intended for students who have successfully completed MATH 2750 Calculus 2 and covers the calculus of several variables. Topics include functions of several variables, three-dimensional analytic geometry, vectors, partial derivatives, multiple integrals, vector fields, surface integrals, Green's Theorem, Stokes Theorem, and the Divergence Theorem. (Prerequisite(s): MATH 2750 Calculus 2 with a grade of "C" or better or appropriate assessment score) (MnTC: Goal 4) 4C/4/0/0

MATH 2760 Differential Equations and Linear Algebra

This course is an introduction to differential equations and linear algebra, which focuses on ordinary differential equations but students will be introduced to partial differential equations. Topics include the basic definition, terminology and ideas of ordinary differential equation, finding solutions of and working with applications of first and second order differential equations, existence and uniqueness of solutions, variation of parameters, undetermined coefficients, matrix formulation of linear systems, Laplace transforms, and an introduction to numerical and graphical methods of solutions. Additional topics include Gauss-Jordan reduction and system of Linear equations, matrices and coordinates relative to different bases, general linear spaces, orthogonality, determinants, eigenvalues, eigenvectors, and phase plane analysis of linear and nonlinear systems of ordinary differential equations. (Prerequisite(s): MATH 2750 Calculus 2 with a grade of "C" or better or appropriate assessment score) (MnTC: Goal 4) 4C/4/0/0

Medical Laboratory Technician

MDLT 1400 Orientation

This course is designed to introduce students to the field of medical laboratory science and the role of the Medical Laboratory Technician in healthcare. The history of the medical laboratory science profession, and its scope of practice including lab practice areas and personnel will be discussed. In addition, the course will cover educational requirements, employment opportunities, certification, licensure, regulation and professional and patient codes of ethics. Must earn a grade of "C" or better in this course to proceed in MDLT Major coursework. (Prerequisite(s): Enrollment in MDLT Major courses) 1C/1/0/0

MDLT 1410 Laboratory Techniques

This course covers basic skills and techniques used in the medical lab which includes basic instrumentation. Major topics covered are: safety and standard precautions, laboratory glassware and pipettes, microscopy, balances and weighing, specimen collection and processing, spectrophotometry, metric/chemistry math and solutions, and laboratory information systems. Must earn a grade of "C" or better in this course to proceed in MDLT Major coursework. (Prerequisite(s): CHEM 1711 and BIOL 1730 or concurrent enrollment) 3C/2/1/0

MDLT 1421 Hematology 1

This course covers basic hematology procedures involving manual methods of cell counting and hemoglobin analysis. Emphasis is placed on hematopoiesis theory and blood cell structure concepts including function, appearance, and cell differentiation. Students will employ a laboratory information system to order tests and report results. Must earn a grade of "C" or better in this course to proceed in MDLT Major coursework. (Prerequisite(s): Enrollment in MDLT Major courses) 2C/1/1/0

MDLT 1422 Hematology 2

This course is a continuation of Hematology 1 in which blood cell differentiation study continues. Hematology instrumentation will be introduced and students will evaluate quality control. Emphasis is placed on correlating laboratory findings with hematologic diseases.

Coagulation theory and laboratory procedures are used to evaluate homeostasis. Students will employ a laboratory information system to order tests and report results. Must earn a grade of “C” or better in this course to proceed in MDLT Major coursework. (Prerequisite(s): MDLT 1421) 4C/1/3/0

MDLT 1430 Urinalysis/Body Fluids

This course covers basic urinalysis procedures used in the clinical laboratory in the examination of a patient’s urine. Students study urine formation, renal physiology, the role of the kidney in health and disease, urine specimen types, and components of the routine urinalysis test. The course also includes an overview of other non-urine body fluids analyzed in the clinical laboratory. In the laboratory, students will perform routine urinalysis using both manual and automated methods. Students will practice using a laboratory information system to order tests and report results. Must earn a grade of “C” or better in this course to proceed in MDLT Major coursework. (Prerequisite(s): Enrollment in MDLT Major courses) 3C/2/1/0

MDLT 1441 Clinical Chemistry 1

This course covers the analysis of various chemical constituents of plasma and serum. The physiology, methodology, and clinical significance of carbohydrates, non-protein nitrogen, and bilirubin is addressed. The course includes a review/overview of renal and liver function including blood tests to assess each. Laboratory Techniques concepts of solution math, spectrophotometry, pipetting and safety will be reviewed and emphasized. Quality assurance concepts, quality control procedures, and manual laboratory techniques will be presented and practiced. POCT procedures will be discussed and practiced. Students will employ a laboratory information system to order tests and report results. Must earn a grade of “C” or better to proceed in MDLT Major coursework. (Prerequisite(s): CHEM 1711 & BIOL 1740 or concurrent enrollment and MDLT 1410) 2C/1/1/0

MDLT 1442 Clinical Chemistry 2

This course covers the continued study of various chemicals in plasma/ serum that are routinely analyzed to contribute to patient care. The physiology, test methodology and clinical correlations of proteins, enzymes, electrolytes, lipids, acid/base balance, and endocrinology are discussed. The course also includes a brief overview of therapeutic drug monitoring and toxicology. Instrumentation principles/ methodologies found in modern clinical chemistry laboratories and concepts that are basic to the operation and maintenance of automated laboratory instruments are covered. Students will test samples and controls using a variety of automated analyzers. Students will employ a laboratory information system to order tests and report results. Must earn a grade of “C” or better to proceed in MDLT Major coursework. (Prerequisite(s): CHEM 1712 and BIOL 1740 or concurrent enrollment and a grade of “C” or better in MDLT 1441 and HLTH 1410) 4C/1/3/0

MDLT 1446 Phlebotomy

This course provides beginning instruction in blood specimen collection skills and procedures. The course addresses safety, legal issues, customer service, professionalism, the circulatory system, equipment, venipuncture, skin puncture procedures, and specimen transport/processing. Students may employ a laboratory information system to document specimen collection. Emphasis is placed on attaining competency in safe blood specimen collection as well as on demonstration of effective communication and professional skills to perform phlebotomy in a health care setting. Must earn a grade of “C” or better to proceed in MDLT Major coursework. (Prerequisite(s): MDLT 1410) 1C/0/1/0

MDLT 1451 Learning Lab 1-Introductory Skills

This course reinforces the basic skills required for gaining proficiency in performing introductory medical laboratory procedures in hematology and basic skills. It is designed to allow completion of hands-on skill activities and enhance attainment of skills in MDLT 1410 and MDLT 1421. Students will be given the opportunity to

perform a variety of laboratory techniques with direct instructor supervision. Must earn a grade of “C” or better in this course to proceed in MDLT Major coursework. Safety, problem solving and quality assurance are emphasized. (Prerequisite(s): Concurrent enrollment in MDLT 1410 and MDLT 1421) 1C/0/1/0

MDLT 1452 Learning Lab 2-Introductory Skills

This course reinforces the basic skills required for gaining proficiency in performing introductory medical laboratory procedures in urinalysis, clinical chemistry, phlebotomy. It is designed to allow completion of hands-on skill activities and enhance practical aspects of MDLT 1430, MDLT 1441, and MDLT 1446. Students will be given the opportunity to perform a variety of laboratory techniques with direct instructor supervision. Safety, problem solving and quality assurance are emphasized. Must earn a grade of “C” or better to proceed in MDLT Major coursework. (Prerequisite(s): Concurrent enrollment in MDLT 1441, MDLT 1430, and MDLT 1446) 1C/0/1/0

MDLT 1453 Learning Lab 3-Intermediate Skills

This course reinforces the basic skills required for attaining proficiency in performing intermediate level medical laboratory procedures in phlebotomy, and clinical chemistry. It is designed to allow completion of hands-on skill activities and enhance practical aspects of MDLT1442. Students will be given the opportunity to perform a variety of laboratory techniques with direct instructor supervision. Safety, problem-solving and quality assurance are emphasized. Must earn a grade of “C” or better to proceed in MDLT Major coursework. (Prerequisite(s): Concurrent enrollment in MDLT 1442) 1C/0/1/0

MDLT 1454 Learning Lab 4-Intermediate Skills

This course reinforces the basic skills required for attaining proficiency in performing intermediate level medical laboratory procedures in phlebotomy, immunology and hematology. It is designed to allow completion of hands-on skill activities and enhance attainment of skills in MDLT 1510 and MDLT 1422. Students will be given the opportunity to perform a variety of laboratory techniques with direct instructor supervision. Must earn a grade of “C” or better in this course to proceed in MDLT Major coursework. Safety, problem solving and quality assurance are emphasized. (Prerequisite(s): Concurrent enrollment in MDLT 1422 and MDLT 1510) 1C/0/1/0

MDLT 1510 Immunology

This course covers basic theory in immunology, non-specific immunity and serological procedures. The reactions of antibodies and antigens are studied and performed in the laboratory. Laboratory procedures are designed to instruct the student in basic serology procedures such as serial dilutions, the use of commercial kits and interpretation of results. Students will employ a laboratory information system to order tests and report results. Must earn a grade of “C” or better in this course to proceed in MDLT Major coursework. (Prerequisite(s): Enrollment in MDLT Major courses) 2C/1/1/0

MDLT 2410 Immunoematology

This course covers the introduction to both the theoretical and practical aspects of Immunoematology, a specialized branch of laboratory medicine which involves the study of blood group antigens and antibodies. Areas of study include a review of immunology concepts, blood group genetics, reagents and quality assurance, antigens and antibodies of the ABO, Rh and other blood group systems, pre- transfusion testing procedures (ABO/Rh typing, antibody screening and identification, cross-match), hemolytic disease of the fetus and newborn, neonatal and obstetric transfusion medicine testing, adverse effects of transfusion, donor screening, and blood component preparation and usage. Students will perform a variety of transfusion medicine laboratory tests utilizing both tube and gel system methods. Must earn a grade of “C” or better in this course to proceed in MDLT Major coursework. (Prerequisite(s): Grade of “C” or better in MDLT 1510) 3C/1/2/0

MDLT 2420 Clinical Microbiology

This course covers the isolation and identification of clinically significant microorganisms. Emphasis is placed on organism's growth characteristics, techniques for identification, safety, and quality assurance. Students will study conventional identification and susceptibility methods along with instrumentation used in the clinical microbiology lab. Students are introduced to recent advances in organism identification techniques. The correlation between pathogens, types of infection, and specimen sources is explored. Must earn a grade of "C" or better in this course to proceed in MDLT Major coursework. (Prerequisite(s): Grade of "C" or better in MDLT 1510) 4C/1/3/0

MDLT 2430 Clinical Practice Orientation

This course explains role of the MDLT student during the practicum phase of the program. Students prepare for the Clinical Practice experience and review theoretical concepts and procedures of testing performed in various clinical laboratory departments. Clinical practice policies and expectations are addressed. Additionally, the application process and timeline of certification is discussed. . Must earn a grade of "C" or better in this course to proceed in MDLT Major coursework. (Prerequisite(s): Grade of "C" or better in all coursework required through the first year including summer term) 1C/1/0/0

MDLT 2455 Learning Lab 5-Advanced Skills

This course reinforces the basic skills required for attaining proficiency in performing medical laboratory procedures in phlebotomy and immunohematology. It is designed to allow completion of hands-on skill activities and enhance practical aspects of MDLT 2410 course. This course also provides an opportunity for the enrolled students to recall and practice key laboratory skills from first-year MDLT courses in preparation for the upcoming MLT Clinical Practice. Students will be given the opportunity to perform a variety of laboratory techniques with direct instructor supervision. Safety, problem-solving and quality assurance are emphasized. Must earn a grade of "C" or better to proceed in MDLT Major coursework. (Prerequisite(s): MDLT 1446 and MDLT 2410) 1C/0/1/0

MDLT 2456 Learning Lab 6-Advanced Skills

This course reinforces the basic skills required for attaining proficiency in performing advanced level medical laboratory procedures in phlebotomy, microbiology, mycology, and parasitology. It is designed to allow completion of hands-on skill activities and enhance attainment of skills in MDLT 2500 and MDLT 2420. Students will be given the opportunity to perform a variety of laboratory techniques with direct instructor supervision. Safety, problem solving, and quality assurance will be emphasized. Must earn a grade of "C" or better in this course to proceed in MDLT Major coursework. Prerequisite(s): Concurrent enrollment in MDLT 2500 and MDLT 2420) 1C/0/1/0

MDLT 2500 Molecular Diagnostics/Advanced Body Fluid Analysis

This course provides a comprehensive overview of the fundamental principles of molecular diagnostics and explores the application of molecular techniques in the medical laboratory. Topics of study include: molecular diagnostic foundation concepts, nucleic acid structure and function, genetics, molecular methodologies and quality assurance. The course also provides an opportunity for advanced study of non-blood, non-urine body fluids, with particular emphasis on hematologic exam. Topics of study include CSF, synovial, and serous fluids. (Pre-requisites: MDLT 1510, MDLT 1430 & MDLT 1422) 2C/1/1/0

MDLT 2591 Clinical Practice

In this clinical laboratory course, the student is provided competency-based instruction in an affiliate hospital/clinic laboratory under the supervision of laboratory professionals. The work-based experience provides an opportunity for students to refine lab techniques and apply knowledge learned in the didactic phase in an employment-like setting with direct patient care that offers realistic experiences unavailable in student laboratory sessions. The experience also

allows students to enhance non-technical attributes including, but not limited to, communication, critical thinking, multi-tasking and independent work skills. Using competency checklists provided by the college laboratory professionals at the affiliate evaluate student clinical skills, application of knowledge, professional behavior and attributes in each department of the clinical laboratory (hematology, chemistry, urinalysis, microbiology, transfusion medicine, and coagulation) and specimen collection and processing skills. Required on-campus afternoons provide learning activities on special topics that assist students in attaining competency in the clinical practice setting. Additional required learning activities assigned by campus faculty that are supplemental to the Clinical Practice competency checklists assist students in maintaining mastery of cognitive theory in major clinical laboratory departments. Must earn a grade of "P" to proceed in MDLT Major coursework. (Prerequisite(s): Grade of "C" or better in all MDLT program requirements) Variable credits 1-9

MDLT 2593 Comprehensive Examinations

Students' knowledge of theory and practical applications in all department areas of the clinical laboratory will be evaluated by comprehensive examinations to assist them in their preparation for the national certification examination desired by potential employers. Students complete final summative evaluations of Clinical Practice experiences and of various components they experienced as a MLT Major. Job placement tracking efforts are described and forms provided. Prerequisite(s): Grade of "C" or better in all required courses in the Medical Laboratory AAS degree including successful completion of MDLT 2591 Clinical Practice) 1C/0/1/0

Medical Office

MEDS 1420 Health Information Foundations

This course introduces the student to the health information management profession by covering topics fundamental to the field such as content, function, structure, and uses of health information, along with the health information profession itself. It covers prominent healthcare data sets, their purpose and use, as well as typical departmental functions associated with managing health information. An introduction of clinical vocabularies and classification systems is covered, as well as secondary data sources such as registries and indexes. Finally, students will learn the history, organization, financing, and delivery of health care services in the United States. Must earn a grade of "C" or better in this course to proceed. 3C/3/0/0

MEDS 1470 Anatomy and Physiology/Medical Office

This course provides the student with an understanding of anatomy and physiology of all systems of the human body. Common disease conditions of each body system will be highlighted. This course provides the student with a fundamental knowledge base for work in the medical office careers field. Must earn a grade of "C" or better in this course to proceed. 3C/3/0/0

MEDS 1480 Medical Terminology

This course exposes the student to the language of healthcare known as medical terminology. The student will develop an understanding of medical terminology by studying the pronunciation and definition of word parts as well as the proper format in bringing word parts together to form medical terms. Development of this foundation is designed to provide a medical vocabulary for future healthcare staff. Must earn a grade of "C" or better in this course to proceed. 3C/3/0/0

MEDS 1551 Medical Formatting/Transcription 1

This course covers formatting and transcription of a variety of medical documents. Emphasis will be on authentic forms and material, formatting, spelling, building speed and accuracy, and proofreading and correcting errors. Must earn a grade of "C" or better in this course to proceed. (Prerequisite(s): MEDS 1480 or concurrent enrollment) 3C/2/1/0

MEDS 1552 Transcription And Documentation II

A continuation of MEDS 1551. A variety of dictated medical material will be produced using electronic equipment. Emphasis will be on authentic forms and material, building speed and accuracy, advanced editing, proofreading and correcting errors. Must earn a grade of “C” or better in this course to proceed. (Prerequisite(s): MEDS 1551) 3C/2/1/0

MEDS 1553 Advanced Medical Documentation

Advanced course that continues the development of medical transcription skills using word processing equipment to produce a variety of usable medical documents. Emphasis will be on authentic material, building speed and accuracy, advanced editing, proofreading and correcting errors. Material will be from physicians from various ethnic backgrounds and will cover various medical specialty areas. Must earn a grade of “C” or better in this course to proceed. (Prerequisite(s): MEDS 1552) 3C/2/1/0

MEDS 1560 Computerized Health Information

An introduction to the concepts of computer technology associated with healthcare and the tools and techniques for collecting, storing and retrieving health care data. This course will explain the difference between data and information as well as discuss networks, data integrity and security, document imaging and automatic identification. Health information systems including administrative, patient registration, ADT, HIM applications, clinical, point of care, lab, radiology, pharmacy and voice recognition, will also be discussed. Must earn a grade of “C” or better in this course to proceed. (Prerequisite(s): MEDS 1420) 3C/3/0/0

MEDS 1562 Billing and Reimbursement

This course provides an introduction to commercial, managed care and federal insurance plans, including medical claim form preparation and processing, as well as the reimbursement systems and prospective payment systems (PPS) used in the healthcare industry. Billing processes and procedures will be discussed and practiced including clean claims and denials and adherence to the National Correct Coding Initiatives. Chargemaster maintenance, regulatory guidelines, and reimbursement monitoring and reporting will be covered, in addition to compliance strategies. Must earn a grade of “C” or better in this course to proceed. (Prerequisite(s): MEDS 1420) 2C/2/0/0

MEDS 1570 Human Disease

This course provides basic information about major disease conditions affecting all the major body systems. Information about diagnostic, treatment, and surgical procedures is also included. Students will do in-depth research on selected disease conditions using Merck Manual and the Internet. They will review and analyze medical reports reflecting the disease conditions that are presented in class. Must earn a grade of “C” or better in this course to proceed. (Prerequisite(s): MEDS 1480 or MEDS 1470 or instructor permission) 3C/3/0/0

MEDS 2430 Pharmacology for the Medical Office

This course offers basic information about drug terminology, drug names (generic and brand), drug classes, and the use of drugs. Drugs frequently prescribed for common disease conditions will be reviewed by body system. Students will use electronic resources and text-based references such as the Physician’s Desk Reference (PDR) to look up detailed information about selected drugs that are being reviewed in class. Must earn a grade of “C” or better in this course to proceed. (Prerequisite(s): MEDS 1480) 2C/2/0/0

MEDS 2432 Alternative Health Record Systems

This course focuses on managing health information in health care facilities other than acute care hospitals. An introduction to the basic components of the content, use and structure of health care data and data sets and how these components link to primary and secondary record systems. Topics to be discussed include the content of the health record, documentation requirements, health care data sets, registries and indices, forms and screen design and primary versus secondary records. An explanation of the organization, financing and delivery of healthcare services will be discussed, as well as a

discussion of such topics as accreditation standards and licensure and regulatory agencies. Must earn a grade of “C” or better in this course to proceed. (Prerequisite(s): MEDS 1420) 2C/2/0/0

MEDS 2434 Legal and Ethical Aspects of Health Information

An introduction to the legal and ethical issues that are relevant to health information. The court system and legislative process, as well as legal vocabulary will be communicated. Topics to be discussed include confidentiality, release of information, retention guidelines, patient rights and advocacy, advanced directives, and ethics. The new HIPAA guidelines will also be reviewed. Must earn a grade of “C” or better in this course to proceed. (Prerequisite(s): MEDS 1420) 2C/2/0/0

MEDS 2440 Supervision of Health Information

An introduction to the principles of supervision and organization in order to develop effective skills in leadership, motivation and team building approaches. Topics will include basic management principles, human resource supervision, budgeting basics, ergonomics, how to market HIM services and performance or quality improvement. Must earn a grade of “C” or better in this course to proceed. (Prerequisite(s): MEDS 1420) 2C/2/0/0

MEDS 2461 ICD-10-CM Coding

This course teaches the student to accurately code diagnoses using the ICD-10-CM coding system. This class brings the student through all of the coding conventions in order to develop a basic coding foundation. Coding of diagnoses from each body system will be covered as well as coding from healthcare documents. Emphasis is on Principle Diagnosis, Secondary Diagnoses, Complications, and Comorbidities. Other topics include DRG’s, coding compliance, over-coding and under-coding. Must earn a grade of “C” or better in this course to proceed. (Prerequisite(s): A grade of “C” or better in MEDS 1470 and MEDS 1480) 3C/3/0/0

MEDS 2462 ICD-10-PCS Coding

This course teaches the student to accurately code procedures using the ICD-10-PCS coding system. This class brings the student through all of the coding conventions in order to develop a basic coding foundation. Coding procedures from each section of ICD-10-PCS will be covered as well as coding from healthcare documents. Emphasis will be on Principle Procedure and Secondary Procedures, DRG’s, coding compliance, over-coding and under-coding. Must earn a grade of “C” or better in this course to proceed. (Prerequisite(s): A grade of “C” or better in MEDS 1470 and MEDS 1480) 4C/4/0/0

MEDS 2470 CPT-4 Coding

This course teaches the student to accurately code procedures using the CPT-4 coding system. This class brings the student through all of the coding conventions in order to develop a basic coding foundation. Coding of procedures from each body system will be covered as well as coding from operative reports, emergency room reports, physician office reports and other healthcare documents. Students will also be trained in coding from all sections within the CPT-4 system as well as Evaluation and Management coding and HCPCS Level 2-National coding. Must earn a grade of “C” or better in this course to proceed. (Prerequisite(s): A grade of “C” or better in MEDS 1470 and MEDS 1480) 3C/3/0/0

MEDS 2480 Advanced Coding

In this course, students will use their basic ICD and CPT coding skills while learning to correctly code diagnoses and procedures from a multitude of source documents such as Inpatient Records; Ambulatory Surgery Records; Emergency Room Reports; Physician Office Cases and Ancillary Service Reports. Students will also become familiar with Diagnosis Related Groups and Ambulatory Payment Classifications. Through instruction in coding these cases, the students will become familiar with what will be expected of them in a real coding position in a healthcare organization. Must earn a grade of “C” or better in this course to proceed. (Prerequisite(s): A grade of “C” or better in MEDS 2461, MEDS 2462 and MEDS 2470) 3C/3/0/0

MEDS 2510 Quality Management and Health Statistics

This course is an introduction to the principles of the quality assessment process which encompasses a framework for gaining skills in collecting and analyzing data. This course covers quality assessment and improvement including collection tools, data analysis and reporting techniques. Utilization management, risk management and case management will also be discussed. This course is also a study of the effective use, collection, arrangement, presentation and verification of health care data. Vital statistics, healthcare statistics and descriptive statistics, as well as reliability and validity of data will be discussed. Research techniques and the IRB process will also be covered. Must earn a grade of "C" or better in this course to proceed. (Prerequisite(s): MEDS 1420 with a grade of "C" or better) 3C/3/0/0

MEDS 2590 HIT Internship/Capstone Project

Students will apply the coursework, theories, skills, and ethics learned during the program to the HIT Internship/Capstone. Under the supervision of a qualified health information professional, the student will gain professional practice and experience, when available, in a healthcare facility. Students will meet written goals and objectives and be evaluated by the Health Information Supervisor and the College Internship Coordinator. The capstone includes a focused review and objective measurement of the Domains and Subdomains required for writing the national certification examination. Students are required to select an independent area of study from a wide-range of topics and disciplines to broaden their scope of interest in health information management. Students work with faculty advisors to schedule the internship, independent study, and healthcare project. Must earn a grade of "C" or better in this course to proceed. (Prerequisite(s): All required coursework for the Health Information Technology AAS Degree with a "C" or better in all MEDS-prefix courses and instructor approval.) 3C/3/0/0

MEDS 2594 Medical Coding Capstone Project

The focus of this class is to simulate 3 credits of on the job experience as a medical coding specialist at a multi-specialty healthcare facility. This internship will provide you with an opportunity to utilize your coding skills and knowledge in an electronic environment. The coding capstone is a vital part of your education that serves as a format to demonstrate your level of expertise. All coding assignments in this course may be compiled into a portfolio to present to a future employer. (Prerequisite(s): All required coursework for the Medical Coding Diploma with a grade of "C" or better or instructor approval.) 3C/3/0/0

Music

MUSC 1030 Applied Strings

Provides private instruction in music -- Instrumental lessons by arrangement with the instructor. Fifteen one-hour lessons per semester. Coursework will be suited to the skill level of the student to develop musical technique. Extra charge for lessons assessed per semester. 2C/0/2/0

MUSC 1310 Applied Voice

Provides private instruction in music -- Vocal lessons by arrangement with the instructor. Fifteen one-hour lessons per semester. Coursework will be suited to the skill level of the student to develop musical technique. Extra charge for lessons assessed per semester. These credits may be repeated up to 8 credits.

MUSC 1320 Applied Piano

Provides private instruction in music -- Instrumental lessons by arrangement with the instructor. Fifteen one-hour lessons per semester. Coursework will be suited to the skill level of the student to develop musical technique. Extra charge for lessons assessed per semester. These credits may be repeated up to 8 credits.

MUSC 1701 Music Theory 1

This course is part 1 of a four-semester sequence in Music Theory. It will focus on the development of written music notation, including scales, tonality, key modes, intervals, triads, seventh chords, roman numeral analysis with bass position symbols, lead-sheet symbols, principles of voice leading and part writing. (Prerequisite(s): READ 0722 Reading 2 with a grade of "C" or better or appropriate assessment score). (MnTC: Goal 6) 2C/2/0/0

MUSC 1702 Aural Skills 1

This course is part 1 of a four semester sequence that should be taken concurrently with the Music Theory sequences. Aural Skills focuses on practical musicianship training in sight singing and ear training. (Prerequisite(s): READ 0722 Reading 2 with a grade of "C" or better or appropriate assessment score). 1C/1/0/0

MUSC 1703 Music Theory 2

This course is part 2 of a four-semester sequence in Music Theory. It will focus on the development of written music notation, including, roman numeral analysis with bass position symbols, lead-sheet symbols, principles of voice leading, part writing, harmonic progressions, sequences, cadences, phrases, periods, sentences, two-part tonal counterpoint and non-chord tones (Prerequisite(s): MUSC 1701 Music Theory I with a grade of "C" or better). (MnTC: Goal 6) 2C/2/0/0

MUSC 1704 Aural Skills 2

This course is part 2 of a four semester sequence that should be taken concurrently with the Music Theory sequence. Aural Skills focuses on practical musicianship training in sight singing and ear training. (Prerequisite(s): MUSC 1701 Music Theory 1 and MUSC 1702 Aural Skills 1 with a grade of "C" or better.) 1C/1/0/0

MUSC 1720 Fundamentals of Music

This course has been designed and structured for students with very little or no musical background. Its goal is to provide you with the tools for a basic understanding of the rudiments of music. Course topics include: The Keyboard, Notation: Staff, and Melody, Clefs, Major Scales, Key Signatures, Minor Scales, Intervals, Triads and The Dominant Seventh Chord, Introduction to Rhythm and Meter, Basic Ear Training Exercises. (Prerequisite(s): READ 0722 Reading 2 with a grade of "C" or better or appropriate assessment score) (MnTC: Goal 6) 3C/3/0/0

MUSC 1730 Concert Choir

This course is a mixed choral ensemble specializing in a wide range of sacred and secular choral literature of all historical periods and nationalities. The ensemble provides singers the opportunity to rehearse, learn and perform repertoire for an a cappella choir as well as repertoire performed with professional instrumental ensembles. The Saint Paul College Concert Choir is open to all students, regardless of major. (MnTC: Goal 6) 2C/0/2/0

MUSC 1735 Class Piano 1

This course is part 1 of a two semester sequence designed to develop basic keyboard and musicianship skills including technique, sight reading, harmonization, accompaniment, theory, and piano repertoire in preparation for the Piano Proficiency Exam. (MnTC: Goal 6) 2C/0/2/0

MUSC 1736 Class Piano 2

This course is part 2 of a two semester sequence designed to develop basic keyboard and musicianship skills including technique, sight reading, harmonization, accompaniment, theory, and piano repertoire in preparation for the Piano Proficiency Exam. (Prerequisite(s): MUSC 1735 with a grade of "C" or better or instructor approval) (MnTC: Goal 6) 2C/0/2/0

MUSC 1740 Music Appreciation

This course is designed to heighten the enjoyment of music by improving listening skills, increasing musical knowledge, and exploring new forms and styles of Western music throughout the centuries. Course topics students will learn include basic elements of

music, musical form and style throughout history, and representative composers and their music. (Prerequisite(s): READ 0722 Reading 2 with a grade of "C" or better or appropriate assessment score) (MnTC: Goals 6 & 8) 3C/3/0/0

MUSC 1745 History of Rock and Roll

The purpose of this course is to explore the emergence of rock and roll music as a cultural phenomenon in the United States. Besides rock and roll, American musical styles including rhythm and blues, country, folk and rock will be studied within a historical and cultural perspective. (Prerequisite(s): READ 0722 Reading 2 with a grade of "C" or better or appropriate assessment score) (MnTC: Goals 6 & 7) 3C/3/0/0

MUSC 1750 Jazz History

This introductory course is designed to help students become familiar with and appreciate jazz as an important American art form. The course follows the historical development of jazz style and innovations to Post-Modern developments and integration with other musical forms. Attendance at a live performance is required. (Prerequisite(s): READ 0722 Reading 2 with a grade of "C" or better or appropriate assessment score) (MnTC: Goals 6 & 7) 3C/3/0/0

MUSC 1760 American Music

This course provides an introduction to folk, ethnic, popular and classical music in the United States. It is designed to help students become familiar with the music from diverse cultural groups and regions of the country. America's Music is an historical overview of the evolution of musical traditions in American society. Attendance at a live performance is required. (Prerequisite(s): READ 0722 Reading 2 with a grade of "C" or better or appropriate assessment score) (MnTC: Goals 6 & 7) 3C/3/0/0

MUSC 1765 Music of Latin America and the Caribbean

This course introduces the musical styles and genres of Latin American and Caribbean music and the mix of aesthetic, cultural, and geographical distinctions that have emerged over time to define and identity the music of the continent. (Prerequisite(s): READ 0722 with a grade of "C" or better or appropriate assessment score) (MnTC: Goals 6 & 7) 3C/3/0/0

MUSC 1770 Music in World Cultures

The aim of this course is to gain a broader understanding of music as worldwide phenomenon through the study of selected musical traditions and cultures of the world. This course will concentrate on the development and historical background of the music, the introduction of typical musical instruments and most well-known musicians of each region, and the relationship between music and the society. (Prerequisite(s): READ 0722 Reading 2 with a grade of "C" or better or appropriate assessment score) (MnTC: Goals 6 & 8) 3C/3/0/0

MUSC 1790 Special Topics in Music

This course is designed to present additional or unique material and learning experiences within a specified discipline. The course will be based on student need, flexibility, and may be designed to meet various transfer and pre-major course requirements. Please see a current Course Schedule for complete course details. (MnTC: Goal 6) Variable credits 1-6

MUSC 1800 Music Production 1

An introductory course in music production using a digital audio workstation. Students will be introduced to standard audio recording and production techniques as well as basic audio theory. (Prerequisite(s): READ 0722 Reading 2 with a grade of "C" or better or appropriate assessment score). (MnTC: Goal 6). 3C/3/0/0

MUSC 2700 Music Theory 3

This course is part 3 of a four-semester sequence in Music Theory. It will focus on the development of written music notation, including roman numeral analysis with bass position symbols, lead-sheet symbols, principles of voice leading, part writing, dominant and

secondary functions, modulations, chromaticism, mode mixture, Neapolitan chords and larger compositional forms. (Prerequisite(s): MUSC 1703 Music Theory 2 (with a grade of "C" or better). (MnTC: Goal 6). 2C/2/0/0

MUSC 2705 Aural Skills 3

This course is part 3 of a four semester sequence that should be taken concurrently with the Music Theory sequence. Aural Skills focuses on practical musicianship training in sight singing and ear training. (Prerequisite(s): MUSC 1703 Music Theory 2 and MUSC 1704 Aural Skills 2 with a grade of "C" or better). 1C/1/0/0

MUSC 2710 Music Theory 4

This course is part 4 of a four-semester sequence in Music Theory. It will focus on the development of written music notation, including, roman numeral analysis with bass position symbols, lead-sheet symbols, principles of voice leading, part writing, augmented sixth chords, enharmonic spellings and modulations, advanced harmonic vocabulary, tonal harmonies of the late nineteenth century, and post-tonal music of the twentieth century. (Prerequisite(s): MUSC 2700 Music Theory 3 (with a grade of "C" or better). (MnTC: Goal 6) 2C/2/0/0

MUSC 2713 Guitar Ensemble

This course consists of the study and performance of standard guitar ensemble literature with emphasis on intonation, rhythmic alignment, balance, style and the requirements of effective ensemble playing. This course will culminate in a public performance. (MnTC: Goal 6) 2C/0/2/0

MUSC 2715 Aural Skills 4

This course is part 4 of a four semester sequence that should be taken concurrently with the Music Theory sequence. Aural Skills focuses on practical musicianship training in sight singing and ear training. (Prerequisite(s): MUSC 2700 Music Theory III and MUSC 2705 Aural Skills III with a grade of "C" or better). 1C/1/0/0

MUSC 2720 Music History 1: Medieval to Baroque

A study of Medieval, Renaissance, and Baroque periods of music. An emphasis is placed on the development of music and its literature within social, cultural, political, and religious contexts. (Prerequisite(s): ENGL 1711) 3C/3/0/0 (MnTC: Goals 6 & 8)

MUSC 2721 Music History 2: Classical to Modern

A study of Classical, Romantic, and Twentieth Century periods of music. An emphasis is placed on the development of music and its literature within social, cultural, political, and religious contexts. (Pre-requisite(s): ENGL 1711) 3C/3/0/0 (MnTC: Goals 6 & 8)

MUSC 2800 Music Production 2

A continuation of MUSC 1800 Music Production 1. This course discusses advanced music production techniques using a digital audio workstation. (Prerequisite(s): MUSC 1800 Music Production 1 with a grade of "C" or better) (MnTC: Goal 6). 3C/3/0/0

Natural Sciences

NSCI 1710 Earth Science

This course introduces students to topics in geology, oceanography, meteorology and astronomy. The solid earth and earth processes, the liquid hydrosphere and the gaseous atmosphere are studied, as well as the earth as a part of the solar system. It is intended for students interested in the natural sciences and can be used to fulfill the lab science requirement. Two hours of lab per week are required. Lab time will be used to reinforce lecture concepts and will include experiments, hands-on activities, and field trips. Traditional, hybrid, and online sections are available. (Prerequisite(s): READ 0722 with a grade of "C" or better or appropriate assessment score) (MnTC: Goals 3 & 10) 4C/3/1/0

NSCI 1721 Introduction to Geology

This course introduces students to the fundamentals of geology, including rock and mineral formation, geologic time, global tectonic processes such as earthquakes and volcanoes, and earth surface processes that change our landscape. Current issues relating to geology, such as global climate change and energy resources will be addressed as well. Two hours of lab per week are required. Lab time will be used to reinforce lecture concepts and will include experiments, hands-on activities and field trips. Traditional and hybrid sections are available. (Prerequisite(s): READ 0722 with a grade of “C” or better or appropriate assessment score) (MnTC: Goals 3 & 10) 4C/3/1/0

NSCI 1730 Introduction to Oceanography

This course introduces students to basic scientific principles of oceanography. Topics covered will include the geological, biological, atmospheric, and chemical processes at work in the oceans, as well as contemporary issues related to marine pollution and resource use. Course includes lab-like learning activities. Traditional and online sections are available. (Prerequisite(s): READ 0721 with a grade of “C” or better or appropriate assessment score) (MnTC: Goals 3 & 10) 3C/3/0/0

NSCI 1740 Introduction to Meteorology

This course introduces students to basic scientific principles of meteorology. Topics include basic properties of the atmosphere, weather terminology, weather phenomena, instrumentation and forecasting. Course includes lab-like learning activities. Traditional and hybrid sections are available. (Prerequisite(s): READ 0721 with a grade of “C” or better or appropriate assessment score) (MnTC: Goals 3 & 10) 3C/3/0/0

NSCI 1750 Natural Disasters

This course introduces students to the investigation of the physical processes, origins of natural disasters and human and economic impacts caused by natural disasters. Content covered will include earthquakes, volcanoes, severe weather, climate change, wildfires, floods and other catastrophic phenomena. Course includes lab-like learning activities. Traditional, online and hybrid sections are available. (Prerequisite(s): READ 0721 with a grade of “C” or better or appropriate assessment score) (MnTC: Goals 3 & 10) 3C/3/0/0

NSCI 1770 Introduction to Energy and the Environment

This course introduces students to energy production, supply, efficiency and the projections of future needs. The potential of solar, biomass, photovoltaics, wind and other continuous flow sources are covered. Crude oil, natural gas, coal and nuclear sources of energy are studied. Environmental, political, economic and ethical considerations are reviewed. Course includes lab-like learning activities. Traditional and hybrid sections are available. (Prerequisite(s): READ 0721 with a grade of “C” or better or appropriate assessment score) (MnTC: Goals 3 & 10) 3C/3/0/0

NSCI 1780 Contemporary Issues in Science

Scientific dilemmas and advances in science make headlines every day. Without knowing the science behind the top issues, it is difficult to separate fact from hype. In this course we will focus on contemporary issues such as climate change, renewable energy, environmental toxins, stem cell research, gene therapy, and pandemic diseases. Students will learn the basic scientific concepts behind each issue and will then explore the ethical dilemmas that each issue brings up. Course includes lab-like learning activities. Traditional, hybrid, and online sections are available. (Prerequisite(s): READ 0721 with a grade of “C” or better or appropriate assessment score) (MnTC: Goals 3 & 9) 3C/3/0/0

NSCI 1782 Minnesota Geology

This course surveys Minnesota’s geological history, from exploring the formation of the bedrock more than 2 billion years ago to the current processes that shape the land usage in this State today. Students will learn about the many ways the state’s geology contributed to the economic, environmental and political

development. Topics include: geologic time, plate tectonics, rock and mineral identification, topographic and geologic maps, superficial processes, and environmental concerns. Through numerous field trips, we will look to the Twin Cities metro area to provide examples of many different earth and environmental processes, and to give us hands-on experience understanding how these processes work (glacial history, rock formations, caves and ancient ocean floor, rivers, and other geologic sites). Course includes lab-like learning activities. Traditional and hybrid sections are available. (Prerequisite(s): READ 0722 with a grade of “C” or better or appropriate assessment score) (MnTC: Goals 3 & 10) 3C/3/0/0

NSCI 1790 Special Topics in Natural Science

This course is designed to present additional or unique material and learning experiences within a specified discipline. The course will be based on student need, flexibility, and may be designed to meet various transfer and pre-major course requirements. Please see a current Course Schedule for complete course details. (MnTC: Goals 3 & 10) Variable credits 1-6

NSCI 2770 Natural Sciences Internship

This course provides students with an opportunity to design and carry out a science research project under the supervision of a faculty advisor. The research report will be prepared using literature review, problem identification, procedural documentation, data collection, data analysis, findings, conclusions, and recommendations. Evaluation will be carried out by faculty teams and experts in the field. The course will also provide an opportunity for field study in an approved internship setting. (Prerequisite(s): Instructor approval) (MnTC: Goal 3) Variable credits 1-4

Nursing Assistant/Home Health Aide

NAST 1111 Nursing Assistant & Home Health Aide

This course introduces concepts of basic human needs, health illness continuum, and basic nursing assistant and home health aide skills. Skills are demonstrated in a supervised laboratory setting. (Prerequisite(s): Nursing Assistant Orientation and appropriate assessment score or grade of “C” or better in READ 0721) 4C/3/1/0

NAST 1112 Nursing Assistant-Clinical

This course will give the student clinical experience in a long-term care facility. Completion of NAST 1111 and NAST 1112 will meet the state and federal criteria for employment in long-term care. The student must attend all hours of clinical. (Prerequisite(s): NAST 1111) 1C/0/1/0

Pharmacy Technology

PHAR 1700 Success Skills for the Pharmacy Technician

This course reinforces the basic skills required for gaining proficiency in performing introductory pharmacy technician knowledge and skills. It is designed to allow completion of skill activities and enhance attainment of skills in PHAR 1710, 1715 and 1730 (first semester pharmacy technician courses). Students will be given the opportunity to perform a variety of pharmacy skills with direct instructor supervision. This course is an elective course and is recommended for students who benefit from direct instructor supervision to reinforce the online learning throughout the first semester of the pharmacy technician program. (Co-requisite (s): PHAR 1710, PHAR 1715, and PHAR 1730) (2C/0/0/0).

PHAR 1710 Pharmacy Law and Ethics

This course will provide the student with the Federal and State laws as they pertain to pharmacy. This course will also address ethical theories and principles as they apply to the area of pharmacy practice. It will assist in preparing the student for the Pharmacy Technician Certification Exam. Must earn a grade of “C” or better to proceed in the Pharmacy Technician program. 3C/3/0/0

PHAR 1715 Fundamentals of Pharmacy Technology 1

Fundamentals of Pharmacy Technology will provide students with a detailed, interactive experience that leads to the understanding of community pharmacy practice, medication safety and communications in health care. Students will participate in active learning activities in the classroom, online and in the pharmacy lab. This course is intended to meet the goals of the model curriculum for pharmacy technician training developed by the American Society of Health-System Pharmacists. This class will provide to the student information necessary for preparation of the Technician Certification Exam in prescription processing. Must earn a grade of "C" or better to proceed in the Pharmacy Technician program. 5C/4/1/0

PHAR 1720 Foundations of Pharmaceutical Calculations

This course will introduce the student to foundational mathematical calculations utilized in pharmacy practice. This course will teach mathematical calculation and problem solving for production of pharmaceutical products. Must earn a grade of "C" or better to proceed in the Pharmacy Technician program. (Prerequisite(s): MATH 0745 or appropriate assessment score) 4C/4/0/0

PHAR 1730 Principles of Pharmacy

This course offers a didactic review of prescription processing with laboratory application. Students will receive skill development and problem solving in non-sterile product preparation. (Prerequisite(s): PHAR 1720 Foundations of Pharmaceutical Calculations) 5C/3/2/0

PHAR 1735 Pharmacy Medication Technology

The student will use technologies within the scope of pharmacy practice. (Prerequisite(s): PHAR 1715 Fundamentals of Pharmacy Technology 1) 1C/1/0/0

PHAR 1740 Success Skills for the Pharmacy Technician 2

This course reinforces the skills required for gaining proficiency in performing intermediate pharmacy technician knowledge and skills. It is designed to allow completion of skill activities and enhance attainment of skills in PHAR 1730, PHAR 1735, and PHAR 2710 (second semester pharmacy technician courses). Students will be given the opportunity to perform a variety of pharmacy skills with direct instructor supervision. This course is an elective course and is recommended for students who benefit from direct instructor supervision to reinforce the online learning throughout the second semester of the pharmacy technician program. (Prerequisite (s): PHAR 1710, PHAR 1715, PHAR 1720) (Co-requisite (s): PHAR 1730, PHAR 1735) 2C/2/0/0.

PHAR 1750 Pharmacy Internship 1 - Retail

Students will receive pharmacy practice experience to refine skills necessary for employment as a pharmacy technician in a retail setting. (Prerequisite(s): PHAR 1730 Principles of Pharmacy with a grade of "C" or better) 3C/0/0/3

PHAR 1800 Pharmacy Technician Certification Exam Preparation

This course prepares students to take the Pharmacy Technician Certification Exam through the Pharmacy Technician Certification Exam Board (PTCB). This course includes instruction on all content areas of the exam, as well as test taking skills. Students take a practice certification exam at the end of the course. This is an elective course, but is highly recommended for students enrolled in the pharmacy technician program and is open to those outside the pharmacy technician program as well who meet the requirements for PTCB certification. (1/1/0/0)

PHAR 2710 Fundamentals of Pharmacy Technology 2

Systems, regulations and applications of pharmacy practice in institutional settings. (Prerequisite(s): PHAR 1715 Fundamentals of Pharmacy Technology 1 with a grade of "C" or better) 5C/4/1/0

PHAR 2700 Success Skills for the Pharmacy Technician 3

This course reinforces the skills required for gaining proficiency in performing advanced pharmacy technician skills. It is designed to allow completion of skill activities and enhancement of skills in PHAR 2720 and PHAR 2740. Students will be given the opportunity to perform a variety of pharmacy skills with direct instructor supervision. This course is an elective course and is recommended for students who benefit from direct instructor supervision to reinforce the online learning throughout the third semester of the pharmacy technician program. (Prerequisite(s): PHAR1730, PHAR1735, PHAR2710). (Co-requisites: PHAR2720, PHAR2750) 1/1/0/0.

PHAR 2720 Pharmacy Sterile Products Lab

This class will provide the student with the knowledge and skills to prepare, calculate, or produce sterile products for pharmaceutical use. (Prerequisite(s): PHAR 2710 Fundamentals of Pharmacy Technology 2) 5C/4/1/0

PHAR 2740 Pharmacotherapy of Disease Processes

The basic concepts of diseases and the mechanisms of disease will be presented. It will include the general physiologic principles for the following systems: nervous, endocrine, skeletal, muscular, cardiovascular, respiratory, gastrointestinal, renal, reproductive, skin, hematologic. The course will discuss immune disorders and immune system responses along with infectious diseases and effects of nutrition and heredity on disease. (Prerequisite(s): PHAR 1715 Fundamentals of Pharmacy Technology 1 with a grade of "C" or better) 4C/4/0/0

PHAR 2750 Pharmacy Internship 2 - Hospital

Experience in the institutional/hospital setting to refine skills learned in previous pharmacy technician coursework. (Prerequisite(s): PHAR 1750 Pharmacy Internship 1 - Retail) 4C/0/0/4

Philosophy

PHIL 1700 Introduction to Philosophy

The purpose of this course is to engage the student in a number of central topics in philosophy through the examination and analysis of the writings of contemporary and major Western philosophers, as well as through the close study of several fundamental issues which have arisen in the course of the development of the Western philosophical tradition. Topics of study will include areas such as the nature of human knowledge, perception and illusion, the nature of consciousness, personal identity, minds, brains and machines, freedom and determinism, philosophy of religion, and the meaning of life. (Prerequisite(s): READ 0722 with a grade of "C" or better or appropriate assessment score) (MnTC: Goal 6) 3C/3/0/0

PHIL 1710 Logic

Logic is the study of arguments. This course uses the tools of symbolic logic to explore logical concepts such as logical truth, consistency, equivalence, and validity. It introduces an artificial, symbolic language that can be used to test the logical properties of statements and arguments. These analytical skills support work in a range of activities that require clear, careful, step-by-step thinking. Although this core falls within the goal of mathematics, it may not apply to certain technical programs or meet certain transfer requirements for mathematics. (Prerequisite(s): READ 0722 with a grade of "C" or better or appropriate assessment score) (MnTC: Goal 4) 3C/3/0/0

PHIL 1715 Philosophy of Scientific Reasoning This course explores philosophical questions about the nature of science and scientific reasoning and helps students build skill at using and evaluating scientific reasoning. For instance, the course will address questions such as: What is the nature of science? Is science compatible with religion? How does science work? Are there limits to the knowledge science can give us? What is the difference between science and pseudoscience? How can we do a good job of understanding and evaluating scientific reasoning, especially when it is reported in

the popular media? The course will explore these questions using historical and contemporary case studies about a variety of subjects, including evolution, astronomy and astrology, and theories and ideas in the social sciences, physics, and biology. The goal of the course will be to use these case studies to explore philosophical questions about the nature of scientific reasoning and to develop their own ability to understand and evaluate scientific reasoning in their lives and career fields. (Prerequisite(s): READ 0721 with a grade of "C" or better or appropriate assessment score) (MnTC: Goal 6) 3C/3/0/0

PHIL 1720 Ethics

This course equips students with philosophical skills and theoretical frameworks useful for fostering productive reflection about ethical controversies. Topics could include the nature and ground of moral judgments, views about what constitutes a good life, theories of right or wrong conduct, and particular moral issues such as animal welfare, civil disobedience, the morality of truth-telling and promising extreme poverty, racism and sexism, gun control, and genetic manipulation. (Prerequisite(s): READ 0722 with a grade of "C" or better or appropriate assessment score) (MnTC: Goals 6 & 9) 3C/3/0/0

PHIL 1722 Health Care Ethics

This course introduces basic ethical theories, principles, and decision-making guidelines used in health care ethics. It examines moral issues confronting health care practitioners, patients, and others involved in medicine. The course includes philosophical analysis of cultural differences regarding medical practices, contemporary moral decision-making on topics such as disclosure, confidentiality, human cloning, medical research, abortion, transplantation and organ markets, allocation of limited resources, conscientious objection, research on human subjects, and euthanasia. The course is open to all students interested in health care ethics. (Prerequisite(s): READ 0722 with a grade of "C" or better or appropriate assessment score) (MnTC: Goals: 6 & 9) 3C/3/0/0

PHIL 1724 Environmental Ethics

This course will focus on helping students develop the ability to understand, analyze, and evaluate moral arguments about the value of nature and our obligations to the natural world and the human and non-human creatures that inhabit it. Topics will include global warming, pollution, animal welfare, anthropocentric and non-anthropocentric views of the value and role of nature, ecofeminism, the moral status of cultural and religious practices that affect the environment, energy and resource policy, conservation and the land ethic, and global and intergenerational justice. The course will include an introduction to basic skills and concepts in ethical theory and applied ethics. (Placement into this course will be according to the College assessment score.) (MnTC: Goals 6 and 10) 3C/3/0/0

PHIL 1742 Greek and Roman Mythology

This survey course introduces students to Greek and Roman myths: stories about gods, heroes and heroines, monsters, the workings of the universe, and how human beings fit in. Myths address various important questions people have, such as "why are human beings on the earth?" "what is the best way to live a life?" and "why is there death?" We will look at how people have attempted to answer and make sense of these questions, as well as consider how these stories are a product of a particular culture and why they were so important to the people that produced them. We will also look at how they have continued to influence culture into the present time. (Prerequisite(s): READ 0722 with a grade of "C" or better or appropriate assessment score) (MnTC: Goals 6 & 8) 3C/3/0/0

PHIL 1750 Eastern Philosophy

The purpose of this course is to acquaint the student with the major Asian philosophies. Students will engage in study of the history and ideas of the following schools of thought: Hinduism, Taoism, Confucianism and Buddhism. This will include examination and analysis of selections from works such as the Upanishads, the Tao Te Ching, the Analects of Confucius and the Dhammapada. Topics of study will include the nature of reality and being, social

philosophy and ways of attaining knowledge. We will compare the ideas of Eastern philosophers on certain fundamental issues with the conclusions of various Western philosophies. The course will be conducted in a discussion format supplemented by instructor lectures. (Prerequisite(s): READ 0722 with a grade of "C" or better or appropriate assessment score) (MnTC: Goals 6 & 8) 3C/3/0/0

PHIL 1760 World Religions

This course is an introduction to the world religions of Hinduism, Buddhism, Judaism, Christianity and Islam. Attention may also be given to indigenous religions and new religious movements. The course will focus on the main practices and beliefs, scriptures, formative periods and historical development of these religions. It will also include ways fundamental religious questions are answered and a critique of religion from a secular perspective. (Prerequisite(s): READ 0721 with a grade of "C" or better or appropriate assessment score) (MnTC: Goals 6 & 8) 3C/3/0/0

PHIL 1770 Feminist Philosophy

Feminist philosophers seek to understand and critique practices and institutions that oppress and subordinate women. They explore questions like: what is the nature of gender oppression, and how is it related to other types of oppression, such as racial oppression? What makes someone a woman or man? Is there a difference between a person's sex and their gender? Are women "naturally" different from men, and would it matter if they were? Is there a male bias in science and ethics? Can a pluralistic society like ours fight women's oppression while also recognizing the rights of cultures to maintain their distinctive practices? In this class, students will work to understand and evaluate prominent feminist answers to these questions, with an emphasis on helping students develop their own well-reasoned views on feminist issues and apply those views to their own lives. (MnTC: Goal 6 & 7) 3C/3/0/0

PHIL 1790 Special Topics in Philosophy

This course is designed to present additional or unique material and learning experiences within a specified discipline. The course will be based on student need, flexibility, and may be designed to meet various transfer and pre-major course requirements. Please see a current Course Schedule for complete course details. (Prerequisite(s): READ 0722 with a grade of "C" or better, or appropriate assessment score) (MnTC: Goal 6) Variable credits 1-6

Phlebotomy

PHLB 1405 Phlebotomy

This course provides instruction in blood specimen collection skills and procedures. The course addresses safety, legal issues, customer service, professionalism, equipment, venipuncture, skin puncture procedures, and specimen transport/processing. Emphasis is placed on attaining competency in safe blood specimen collection and effective sample processing/handling to preserve specimen integrity as well as on demonstration of effective communication and professional skills to function in a health care setting. (Prerequisite(s): HLTH 1410, BIOL 1730, PHIL 1722, COMM 1710 or COMM 1720, HLTH 1430 or HLTH 1432 or concurrent enrollment) 4C/2/2/0

PHLB 1410 Phlebotomy Clinical Experience

This course provides concentrated practice and phlebotomy skill development in a health care setting (affiliate) where information learned in PHLB 1400 can be applied. Students work under the guidance and supervision of clinical staff at the assigned affiliate. Demonstration of a minimum of 100 successful blood collection procedures is required. The specific class times will vary according to the assigned site. (Prerequisite(s): PHLB 1400) 2C/0/0/2

Physics

PHYS 1720 Principles of Physics 1

This course introduces students to fundamental principles of physics and their application to familiar phenomena. Topics include motion, fluids, heat, work, forces, gravity, waves and sound, and energy. The topics will be related to modern technology and everyday phenomena. The course is intended for students who have not had a high school physics course. Class includes lecture and lab. (Prerequisite(s): MATH 1730 with a grade of “C” or better) (MnTC: Goal 3) 4C/3/1/0

PHYS 1722 Principles of Physics 2

This course is a continuation of PHYS 1720 Principles of Physics 1. It covers electricity and magnetism, light and optics, simple circuits, topics in modern physics and applications and technology. Class includes lecture and lab. (Prerequisite: PHYS 1720 Principles of Physics 1) (MnTC: Goal 3) 4C/3/1/0

PHYS 1760 Descriptive Astronomy (no lab)

This course introduces students to astronomy. It includes the observation of the planets and stars weather permitting. The course will include topics such as life and death of stars, dark matter, formation of a solar system, the Big Bang Theory and more. Course includes lab-like learning activities. (Prerequisite(s): READ 0721 with a grade of “C” or better or appropriate assessment score) (MnTC: Goals 3 & 10) 3C/3/0/0

PHYS 2700 General Physics 1 (with Calculus)

Calculus-based course with a study of Kinematics, Dynamics, Laws of Motion, Gravitation, Kinetic and Potential Energy; Conservation of Energy; Linear and Angular momentum; Equilibrium and Fluid Dynamics. Designed to fulfill physics requirements for students in liberal arts and sciences, engineering, and other related science fields. Class includes lecture and lab. High School Physics is recommended. (Prerequisite(s): MATH 2749 Calculus 1 with a grade of “C” or better) (MnTC: Goal 3) 5C/4/1/0

PHYS 2710 General Physics 2 (with Calculus)

Continuation of General Physics 1 (with Calculus). Topics include: Wave Phenomenon, Fluids, Electricity and Magnetism; electrical circuits, light and optics. Designed to fulfill physics requirements for students in liberal arts and sciences, engineering, and other related science fields. Class includes lecture and lab. (Prerequisite(s): PHYS 2700 General Physics 1 with a grade of “C” or better) (MnTC: Goal 3) 5C/4/1/0

PHYS 2760 Introductory Astronomy (with lab)

This course is designed for the non-science student who wants to know more about astronomy. We’ll be studying the motion of the night sky, the planets and what shapes them, how stars are made and what happens when stars die all the way out to the edges of the known universe. Topics of note will include Planetary Formation, Extra Solar Planet Search, Dark Matter, Dark Energy, the Expanding Universe, and many more fun topics! This course includes a laboratory component with hands on activities to help build understanding. (Prerequisite(s): MATH 0745 with a grade of “C” or better or appropriate assessment score) (MnTC: Goals 3 & 10) 4C/3/1/0

PHYS 2790 Special Topics in Physics

This course is designed to present additional or unique material and learning experiences within a specified discipline. The course will be based on student need, flexibility, and may be designed to meet various transfer and pre-major course requirements. Please see a current Course Schedule for complete course details. (MnTC: Goal 3) Variable credits 1-6

Pipefitting

PIPE 1410 Pipe Science/Math

Study of selected branches of physics and math applied to pipefitting. Areas covered include properties of matter, heat, math and mechanics. Must earn a grade of “C” or better in this course to proceed. (Prerequisite(s): Must be enrolled in Pipefitting pre-apprenticeship program) 5C/2/3/0

PIPE 1420 Pipe Blueprint Reading

Study of basic drafting principles as they relate to piping drawing and blueprints. Must earn a grade of “C” or better in this course to proceed. (Prerequisite(s): Must be enrolled in Pipefitting pre-apprenticeship program) 3C/1/2/0

PIPE 1430 Pipe Welding 1

Basic course in oxyacetylene welding and cutting of pipe. Must earn a grade of “C” or better in this course to proceed. (Prerequisite(s): Must be enrolled in Pipefitting pre-apprenticeship program) 5C/1/4/0

PIPE 1441 Basic Heating 1

Introductory course on low pressure steam. Areas include boiler, piping and heat transfer units. Must earn a grade of “C” or better in this course to proceed. (Prerequisite(s): Must be enrolled in Pipefitting pre-apprenticeship program) 3C/1/2/0

PIPE 1442 Basic Heating 2

This course is a basic study of hydronic heating systems. Areas include systems, piping layout and figuring heat loss. Must earn a grade of “C” or better in this course to proceed. (Prerequisite(s): Must be enrolled in Pipefitting pre-apprenticeship program) 3C/1/2/0

PIPE 1451 Pipe Shop 1

Care and use of tools and equipment and uses of different types of pipe fittings, hangers and the assembly of pipe and fittings are covered. Must earn a grade of “C” or better in this course to proceed. (Prerequisite(s): Must be enrolled in Pipefitting pre-apprenticeship program) 4C/0/4/0

PIPE 1452 Pipe Shop 2

Course consists of tube bending, flaring, soldering, brazing and rigging. Must earn a grade of “C” or better in this course to proceed. (Prerequisite(s): PIPE 1451 and must be enrolled in Pipefitting pre-apprenticeship program) 4C/0/4/0

PIPE 1455 Introduction to Apprentice Pipe Welding 1

Basic course in pipe welding and cutting of pipe. Must earn a grade of “C” or better in this course to proceed. (Prerequisite(s): Must be enrolled in Pipefitting apprenticeship program.) 2C/0/2/0

PIPE 1522 Basic Air Conditioning and Refrigeration

Fundamental concepts of air conditioning are presented. Areas include air treatment, moisture content, ventilation and purity. Must earn a grade of “C” or better in this course to proceed. (Prerequisite(s): PIPE 1451 and must be enrolled in Pipefitting pre-apprenticeship program) 2C/1/1/0

PIPE 1530 Pipe Welding 2

Basic course in arc welding on plate and pipe. Must earn a grade of “C” or better in this course to proceed. (Prerequisite(s): PIPE 1451 and must be enrolled in Pipefitting pre-apprenticeship program) 5C/0/5/0

PIPE 1540 Electric Controls

Fundamentals of electricity and electrical circuits are covered. Must earn a grade of “C” or better in this course to proceed. (Prerequisite(s): PIPE 1451 and must be enrolled in Pipefitting pre-apprenticeship program) 3C/1/2/0

PIPE 1550 Basic Gas

This is an introductory course on gas used in gas fired heating systems. Areas covered include natural gas burners, LP gas burners, pipe sizing, flue venting, electricity and safety pertaining to gas fired systems. Must earn a grade of “C” or better in this course to proceed. (Prerequisite(s): PIPE 1451 and must be enrolled in Pipefitting pre-apprenticeship program) 3C/2/1/0

PIPE 2605 Pipefitting 1

Basic knowledge necessary to the beginning of a pipefitting career. 2C/0/2/0

PIPE 2606 Pipefitting 2

This course is designed to fill out an experienced pipefitter’s resume based on knowledge and acquiring certification levels. 2C/0/2/0

PIPE 2614 Boiler Systems

This course is intended to provide the apprentice a strong foundation in stationary steam engineering, separate or combined low and high pressure and liquid systems. 2C/1/1/0

PIPE 2615 Pipe Layout and Installation 1

Care and use of tools and equipment used by the pipefitter. Study the pipe math necessary for pipe installation. Different types of pipe, pipe fittings, hangers and supports. Skills needed to install steel threaded pipe with both straight and offset runs. (Prerequisite(s): Must be enrolled in the Pipefitter apprenticeship program) 2C/0/2/0

PIPE 2616 Pipe Layout and Installation 2

Advanced pipe layout math skills. Skills needed to run copper, PVC, CPVC. This will include soldering, bending, and flaring copper. Threading, gluing, and fusing of plastic pipe. Students will have the opportunity to receive a Certification in Fusion Installation. (Prerequisite(s): Must be enrolled in the Pipefitter apprenticeship program) 2C/0/2/0

PIPE 2623 Apprenticeship Refrigeration & Air Conditioning

This course covers applied refrigeration and air conditioning for first year pipe trade apprentices. The course focuses on the understanding of refrigeration theory and its application as it relates to the installation, operation, maintenance, troubleshooting, and repair of residential, commercial, industrial, and institutional refrigeration and air conditioning systems. A strong emphasis is placed on electrical theory, electrical application, electrical code, and electrical safety, as it applies to both low and high voltage circuits of air conditioning and refrigeration equipment. (Prerequisite(s): Must be enrolled in the Pipefitter apprenticeship program) 2C/0/2/0

PIPE 2625 Steam, Hot Water & Gas Controls

This course is intended to provide the apprentice with information and skill for the proper piping of refrigeration, hot water and high-pressure steam. (Prerequisite(s): Must be enrolled in the Pipefitter apprenticeship program) 2C/0/2/0

PIPE 2626 Basic Service Applications

This course is intended to provide a fundamental understanding of the various mechanical equipment and controls associated with heating and air conditioning equipment. Basic schematics, fundamentals of electricity and in-field troubleshooting techniques will also be covered. (Prerequisite(s): Must be enrolled in the Pipefitter apprenticeship program) 2C/0/2/0

PIPE 2627 Basic Electricity

This course is intended to provide the apprentice a basic understanding of electricity. This course will combine both text and practical hands-on work. (Prerequisite(s): Must be enrolled in the Pipefitter apprenticeship program) 2C/0/2/0

PIPE 2628 Commercial Pneumatics

This course is on learning control of modern air conditioning, ventilation, and heating equipment. Part of the course will be on design, service, and basic understanding of various air handling systems. Another part will be hands on pneumatic and electric controls. (Prerequisite(s): Must be enrolled in the Pipefitters apprenticeship program) 2C/0/2/0

PIPE 2631 Instrumentation

This course provides an understanding of instrumentation, controls and pneumatics for industrial, manufacturing and process plants. 2C/0/2/0

PIPE 2632 Commercial Refrigeration

This course encompasses electrical wiring diagrams electronic control theory and circuits related to the components used in the installation and repair of Refrigeration systems. Refrigeration mechanical components and related equipment and tools used for installation and repair. (Prerequisite(s): Must be enrolled in the Pipefitting pre-apprentice program) 2C/0/2/0

PIPE 2636 Electrical Controls and Diagrams

This is an in-depth study of electrical controls and motors as there applied to heating, ventilation, air-conditioning, and refrigeration. Here you will gain a foundation, designed to prepare you for the real world of service in the HVAC industry. The focus in this course is on electrical controls, motors and their control. With a large emphasis of your time will be making diagrams and preparation for shop projects. Prepare you for the challenges you will face servicing HVACR equipment. The project design is to develop the skills needed to work safely and efficiently in this trade. (Prerequisite(s): Must be enrolled in the Pipefitter apprenticeship program) 2C/0/2/0

PIPE 2638 Computer Controls

This course is designed to assist students in understanding computer concepts including the functions of the Internet and the Web. (Prerequisite(s): Must be enrolled in the Pipefitter apprenticeship program) 2C/0/2/0

PIPE 2641 Foreman Leadership

This course will cover both the METAL and the MENTAL aspect of the role of Foreman/Supervisor, as well as how to deal with both employers (management) needs and wants, and following the rules of labor unions, OSHA, demanding General Contractors and others. (Prerequisite(s): Must be enrolled in the Pipefitter apprenticeship program) 2C/0/2/0

PIPE 2642 Piping Design

This course will introduce the fundamentals in the design of ASNE B31.1 Power Piping, material selection, and supports. The course will provide the UA Apprentice examples of applications of power piping codes, and proper piping material selection and installation. Classroom examples will be demonstrated on the fundamentals of ordering materials, calculating pipe hanger loads, flexibility analysis, design of expansion loops, cold springing, hanger selection and installation, hanger spacing and inspection, and reaction forces on piping systems. The course will provide hands-on experience in the installation of constant and variable spring hangers and proper piping installation practices. (Prerequisite(s): Must be enrolled in the Pipefitter apprenticeship program) 2C/0/2/0

PIPE 2643 Test and Balance of Systems

This course covers the necessary steps for pipe trades apprentices and journeymen to start up, test, and balance heating, ventilation, and air conditioning systems. Students shall learn to test and balance systems by instruction and hands-on experience in measuring quantities such as pressures, temperature, the rates at which air and water are flowing, and electrical current and voltage. These measurements are then compared with corresponding quantities called for by the design specifications, and any necessary regulating is done to make actual

measurements meet required values. (Prerequisite(s): Must be enrolled in the Pipefitter apprenticeship program) 2C/0/2/0

PIPE 2644 Power Burners and Controls

This is a course on gas and oil power burners and related control systems. The course will include flame safety controls and boiler controls. Also included will be different boiler and burner types and designs. (Prerequisite(s): Must be enrolled in the Pipefitter apprenticeship program) 2C/0/2/0

PIPE 2645 Direct Digital Controls

This course is focused on computer based electronic control systems that control a wide variety of heating, ventilating, air conditioning, refrigeration (HVACR) and other equipment installed in buildings which regulate environmental systems. (Prerequisite(s): Must be enrolled in the Pipefitter apprenticeship program) 2C/0/2/0

PIPE 2651 Refrigeration Code

This course is designed to prepare students for the City of Saint Paul Competency Card in refrigeration code. (Prerequisite(s): Must be enrolled in the Pipefitting pre-apprentice program) 1C/0/1/0

PIPE 2652 Oil Code

This course covers the installation and repair of fuel oil burning equipment, storage tanks and piping systems. Codes governing the installation and start up and service of this equipment will be covered. The emphasis in this course will be to apply knowledge learned in this class to the safe and proper installation and service of equipment and to obtain a certificate of competency for this work. (Prerequisite(s): Graduate of Pipefitting day school program or pipefitting work experience) 1C/0/1/0

PIPE 2653 Gas Code

This course covers the installation and repair of gas burning equipment and piping systems. Codes governing the installation and start up and service of this equipment will be covered. (Prerequisite(s): Graduate of Pipefitting day school program or pipefitting work experience) 1C/0/1/0

PIPE 2654 Hot Water Code

This course is intended to provide the student with information on the proper and safe piping of hot water. (Prerequisite(s): Graduate of Pipefitting day school program or pipefitting work experience) 1C/0/1/0

PIPE 2655 Ammonia Code

The purpose of this course is for registered Pipefitter Apprentices to learn and understand the Minnesota Department of Labor and Industry, High Pressure Piping and Code for Power Piping Systems. Registered apprentices shall also be instructed in the current proper piping practices for the installation of steam, hot water, oil, and ammonia refrigeration systems. 2C/0/2/0

PIPE 2656 High Pressure Steam Code

The purpose of this course is for registered pipefitter apprentices to learn and understand the Minnesota Department of Labor and Industry, High Pressure Piping and Code for Power Piping Systems. Registered apprentices shall also be instructed in the current proper piping practices for the installation of high steam pressure steam systems. 2C/0/2/0

PIPE 2657 Advanced Boiler Systems

Review of Hydronics heating and cooling systems. Introduction to boiler types, such as fire tube, water tube, condensing, and no condensing boilers. Students will understand hot water, low pressure steam, and high pressure steam boilers. Learning how to size pipe to attain delivery of desired BTU's to equipment. Discussion and understanding of the different burner fuel systems, as in natural gas, oil, propane, and electric. Students will understand burner ignition, and flame safety. Thorough coverage of pumps for HVAC systems, covering different types, i.e. positive displacement, and non positive

displacement, pump installation, alignment, and repair. Pumping system calculations on pumping head & GPMs and pump curve analysis. 2C/0/2/0

PIPE 2658 OSHA 30/Pro 10/ Heritage/Standard

This course covers Industry safety practices professionalism, communication and mutual respect. Also covered is United Association History: how the United Association became an organization of trade workers, the importance of the collective bargaining agreement, and work site performance. 2C/0/2/0

PIPE 2659 Commercial Building Systems

Covers industry safety standards, ASHRAE standards, HVAC-R Star Certification program curriculum. 2C/0/2/0

PIPE 2660 Industrial Rigging

Knowledge required to properly rig and lift piping and equipment associated with the installation of piping systems. 2C/0/2/0

Plumbing

PLMB 2610 PreApprentice Plumbing

This is an introductory course on the use of tools, materials and fittings used in the plumbing field. (Prerequisite(s): Must be enrolled in the Plumbing apprentice program) 2C/0/2/0

PLMB 2612 Job Safety & Health

This course provides knowledge of jobsite hazards and work safety. (Prerequisite(s): Must be accepted into the Plumbing apprentice program) 2C/0/2/0

PLMB 2614 Applied Math for Plumbing

This course covers basic mathematics and practical application to plumbing. (Prerequisite(s): Must be enrolled in the Plumbing apprentice program) 4C/0/4/0

PLMB 2616 Plumbing Welding

This is an introductory course in welding and the principles used in welding. (Prerequisite(s): Must be enrolled in the Plumbing apprentice program) 4C/0/4/0

PLMB 2618 Basic Drawing

This course introduces the student to basic concepts of drafting, blueprints and plan specifications used in the construction field. (Prerequisite(s): Must be enrolled in the Plumbing apprentice program) 4C/0/4/0

PLMB 2621 Plumbing 1

This course introduces the student to basic scientific principles applied in plumbing. It will introduce the student to drainage and vent systems and the Minnesota State Plumbing Code. (Prerequisite(s): Must be enrolled in the Plumbing apprentice program) 4C/0/4/0

PLMB 2622 Plumbing 2

This course covers proper pipe sizing and installation of piping systems, the installation of plumbing fixtures, appliances and methods used in the installation and repair of these systems. (Prerequisite(s): Must be enrolled in the Plumbing apprentice program) 4C/0/4/0

PLMB 2623 Plumbing 3 Gas Installations & Gas Controls

This course introduces the student to fundamental principles of gas burning appliances and the service and repair of these appliances and systems. (Prerequisite(s): Must be enrolled in the Plumbing apprentice program) 4C/0/4/0

PLMB 2624 Plumbing 4 Commercial & Residential Service

This course introduces students to tools and methods used in servicing and repair of plumbing systems in residential and commercial buildings. (Prerequisite(s): Must be enrolled in the Plumbing apprentice program) 4C/0/4/0

PLMB 2631 Plumbing Code 1

This course covers the Minnesota State Plumbing code and looks at each section in detail. (Prerequisite(s): Must be enrolled in the Plumbing apprentice program) 2C/0/2/0

PLMB 2632 Plumbing Code 2

This course covers the Minnesota State Plumbing code and is a continuation of Plumbing Code 1. (Prerequisite(s): Must be enrolled in the Plumbing apprentice program) 2C/0/2/0

PLMB 2633 Plumbing Code 3

This course covers the Minnesota State Plumbing code and is a continuation of Plumbing Code 2. (Prerequisite(s): Must be enrolled in the Plumbing apprentice program) 2C/0/2/0

PLMB 2634 Plumbing Code 4

This course covers the Minnesota State Plumbing code and is a continuation of Plumbing Code 3. (Prerequisite(s): Must be enrolled in the Plumbing apprentice program) 2C/0/2/0

PLMB 2640 Advanced Blueprint Reading & Heavy Rigging

Study of basic blueprint reading and layout and pipe drawings related to the plumbing field. This course also introduces the student to basic rigging. (Prerequisite(s): Must be enrolled in the Plumbing apprentice program) 4C/0/4/0

PLMB 2650 Industrial Plumbing

This is an introductory course to industrial plumbing work. It focuses on welding, rigging and materials used in industrial plumbing work. (Prerequisite(s): Must be enrolled in the Plumbing apprentice program) 4C/1/3/0

Political Science

POLS 1720 Introduction to American Government

This course provides an overview of the American political system. The course focuses on the principles of the constitution; the concept and processes of federalism; the interaction between the executive, legislative and judicial branches of government; the emergence of political parties, popular opinion, political campaigns; the evolution of domestic and foreign policy; and the role of the media in US politics. (Prerequisite(s): READ 0721 with a grade of "C" or better or appropriate assessment score.) (MnTC: Goals 5 & 9) 3C/3/0/0

POLS 1740 Introduction to World Politics

This course introduces core themes, concepts, and debates in the study of international politics. This course will focus on the causes of war, the global economy, human rights, and humanitarian intervention. Prerequisite(s): READ 0721 with a grade of "C" or better or appropriate assessment score.) (MnTC: Goals 5 & 8) 3C/3/0/0

POLS 1750 Introduction to Political Science

This course provides an introduction to political science with an emphasis on democracy, ideologies and current issues. We will explore how ideological differences lead to disagreements on a variety of global and domestic issues. (Prerequisite(s): READ 0721 with a grade of "C" or better or appropriate assessment score) (MnTC: Goals 5 & 9) 3C/3/0/0

POLS 1760 Introduction to Political Philosophy

This course provides an introduction to enduring themes and questions in the history of political philosophy. We will study a selection of both historical and contemporary thinkers as a way to investigate the social, moral and political foundations of modern society. (Prerequisite(s): READ 0721 with a grade of "C" or better or appropriate assessment score) (MnTC: Goals 5 & 9) 3C/3/0/0

POLS 1790 Special Topics in Political Science

This course is designed to present additional or unique material and learning experiences within a specified discipline. The course will be based on student need, flexibility, and may be designed to meet various transfer and pre-major course requirements. Please see a current Course Schedule for complete course details. (MnTC: Goals 5 & 9) Variable credits 1-6

Practical Nursing

PRNS 1425 Essentials of Clinical Pharmacology

This course introduces the concepts of pharmaceuticals and dosage math. Included is information on pharmacokinetics, pharmacodynamics, common adverse side effects, and contraindications to drug use. Emphasis is placed on drug classifications and safe administration of medications to patients across the life span. Dosage math includes information on the systems of measurement, conversions, solving for x, ratio and proportions, pediatric formulas, and IV drip rate problems. Must earn a grade of "C" or better in this course to proceed. (Prerequisite(s): MATH 0745 or appropriate assessment score. Grade of "C" or better in HLTH 1410, BIOL 1730, ENGL 1711 and PSYC 1720. Must be accepted as a Practical Nursing major.) 2C/2/0/0

PRNS 1435 Foundations of Nursing

Students in Foundations of Nursing are introduced to basic theory and nursing skills required to care for patients of both genders throughout the lifespan, with particular emphasis on the geriatric patient. Students are given the opportunity to demonstrate these skills in the laboratory setting. An introduction to the nursing process provides the student with a beginning framework for decision making. The concepts of teamwork, collaboration, safety, quality improvement, professional identity/behavior, patient-centered care, evidence based practice, and care management are introduced. Must earn a grade of "C" or better in this course to proceed. (Prerequisite(s): Grade of "C" or better in HLTH 1410, BIOL 1730, ENGL 1711 and PSYC 1720. Must be accepted as a Practical Nursing major.) 4C/1/3/0

PRNS 1436 Foundations of Nursing

Students in Foundations of Nursing are introduced to basic theory and nursing skills required to care for patients of both genders throughout the lifespan, with particular emphasis on the geriatric patient. Students are given the opportunity to demonstrate these skills in the laboratory setting. An introduction to the nursing process provides the student with a beginning framework for decision making. The concepts of teamwork, collaboration, safety, quality improvement, professional identity/behavior, patient-centered care, evidence based practice, and care management are introduced. Must earn a grade of "C" or better in this course to proceed. (Prerequisite(s): Grade of "C" or better in HLTH 1310 Communications in Healthcare, HLTH 1410 Medical Terminology, BIOL 1730 Human Body Systems, ENGL 1711 Composition I, and PSYC 1720 Psychology throughout the Lifespan (All prerequisites must have a minimum grade of 2.0 GPA equivalent). Must be accepted as a Practical Nursing major.) 4C/2/2/0

PRNS 1481 Clinical 1

This course provides students the opportunity to work with health care personnel, apply learned basic skills, the nursing process, and critical thinking in caring for assigned patients. Students will follow

plans of care, deliver safe and competent cares to patients of both genders, and complete written clinical assignments applying to theory learned in Level I. Students will demonstrate competency within the Practical Nurse scope of practice under the direction of a nursing instructor. Must earn a grade of "C" or better in this course to proceed. (Prerequisite(s): Grade of "C" or better in PRNS 1425, PRNS 1435, PRNS 2410 and PRNS 1521) 3C/0/3/0

PRNS 1482 Clinical 2

In this clinical course, the Practical Nursing students will maintain a safe and effective care environment while taking care of selected patients throughout the life span. Students will implement cares and skills learned in prior Practical Nursing theory and lab courses while functioning within the roles and limitations of the LPN scope of practice. Students will use patient centered cares in collaboration with teamwork to meet the basic needs of assigned patients. Students will maintain professional identity by demonstrating dependability and accountability. Must earn a grade of "C" or better in this course to proceed. (Prerequisite(s): Grade of "C" or better in PRNS 1481, PRNS 1524 and PRNS 2410) 3C/0/3/0

PRNS 1483 Clinical 3

In this clinical course, the Practical Nursing students will care for selected patients in specialty areas (med/surg, psychosocial nursing, pediatrics and obstetrics) to afford them a well-rounded experience. Students will implement patient centered cares learned in prior theory and lab courses. Students will continue to use LPN scope of practice as a guide to implement a safe and effective care environment, and medication administration will be safe. Students will demonstrate professional identity by being dependable and accountable for actions. Must earn a grade of "C" or better in this course to proceed. (Prerequisite(s): Grade of "C" or better in PRNS 1482 and PRNS 1530) 3C/0/3/0

PRNS 1521 Nursing Care of Adults 1

This theory course is a detailed study of pathophysiology of adult patients. Students use their knowledge of normal physiology. Sensory, neurological, musculoskeletal, integumentary, hematologic, lymphatic, immune and infectious disease disorders are studied. Course topics also include fluid/electrolyte imbalance, pain management, pre- and post-operative care, oncology and gerontology. Students apply knowledge based on patient-centered care within the practical nurse scope of practice in preparation to provide safe, quality care. Must earn a grade of "C" or better in this course to proceed. (Prerequisite(s): Grade of "C" or better in HLTH 1410, BIOL 1730, ENGL 1711, PSYC 1720. Must be accepted as a Practical Nursing major.) 4C/4/0/0

PRNS 1524 Nursing Care of Adults 2

This theory course continues the study of pathophysiology of adult patients. Genitourinary/reproductive, cardiovascular, gastrointestinal, respiratory and endocrine system disorders are studied. Students at this level continue utilizing critical thinking to apply information to situations in a safe and effective care environment. Principles of inter-professional teams and shared decision-making are studied and discussed in preparation for clinical experiences. Must earn a grade of "C" or better in this course to proceed. (Prerequisite(s): Grade of "C" or better in HLTH 1410, BIOL 1730, ENGL 1711, PSYC 1720. Must be accepted as a Practical Nursing major.) 3C/3/0/0

PRNS 1530 Maternal Child Health

This course is designed to build on the student's understanding of child growth and development and the basic health needs of the mother, the newborn infant, and the family during pregnancy, labor, delivery, and post-partum period. It provides an overview of the LPN scope of practice when caring for the obstetric and pediatric patient. Patient centered care is emphasized while discussing common pediatric disorders, recommended plans of care, and the concepts of prevention and treatment. Concepts of teamwork and collaboration are integrated throughout the course along with a specific group project each student must complete and present. Upon completion of this course, students

will be able to describe safe and effective care utilizing the nursing process for the obstetric and pediatric patient. Must earn a grade of "C" or better in this course to proceed. (Prerequisite(s): Grade of "C" or better in PRNS 1482 and PRNS 1524) 3C/3/0/0

PRNS 1531 Maternal Child Health

This course is designed to build on the student's understanding of child growth and development and the basic health needs of the mother, the newborn infant, and the family during pregnancy, labor, delivery, and post-partum period. It provides an overview of the LPN scope of practice when caring for the obstetric and pediatric patient. Patient centered care is emphasized while discussing common pediatric disorders, recommended plans of care, and the concepts of prevention and treatment. Concepts of teamwork and collaboration are integrated throughout the course along with a specific group project each student must complete and present. Upon completion of this course, students will be able to describe safe and effective care utilizing the nursing process for the obstetric and pediatric patient. Must earn a grade of "C" or better in this course to proceed. (Prerequisite(s): Grade of "C" or better in prerequisite courses. PRNS 1425 Essentials of Clinical Pharmacology, PRNS 1435 Foundations of Nursing, PRNS 1481 Clinical I, PRNS 1521 Nursing Care of Adults I, PRNS 2411 Psycho/Social Nursing.) 2C/2/0/0

PRNS 2410 Psycho/Social Nursing

This course is designed to build on the student's understanding of human behavior and provides an overview of the LPN scope of practice when caring for patients with alterations in mental health. Patient-centered care is emphasized while exploring common mental health disorders such as depression, anxiety, schizophrenia, bipolar disorder, eating disorders, and cognitive disorders. Concepts of teamwork and collaboration are integrated throughout the course. The basic components of evidence-based practice are introduced. Upon completion of this course, students will be able to describe safe and effective patient care to maintain psychosocial integrity by using the nursing process. Must earn a grade of "C" or better in this course to proceed. (Prerequisite(s): Grade of "C" or better in, HLTH 1410, BIOL 1730, ENGL 1711, and PSYC 1720. Must be accepted as a Practical Nursing major.) 2C/2/0/0

PRNS 2411 Psycho/Social Nursing

This course is designed to build on the student's understanding of human behavior and provides an overview of the LPN scope of practice when caring for patients with alterations in mental health. Patient-centered care is emphasized while exploring common mental health disorders such as depression, anxiety, schizophrenia, bipolar disorder, eating disorders, and cognitive disorders. Concepts of teamwork and collaboration are integrated throughout the course. The basic components of evidence-based practice are introduced. Upon completion of this course, students will be able to describe safe and effective patient care to maintain psycho/social integrity by using the nursing process. Must earn a grade of "C" or better in this course to proceed. (Prerequisite(s) Grade of "C" or better in HLTH 1310 Communications in Healthcare, HLTH 1410 Medical Terminology, BIOL 1730 Human Body Systems, ENGL 1711 Composition I, PSYC 1720 Psychology throughout the Lifespan.(All prerequisites must have a minimum grade of 2.0 GPA equivalent). Must be accepted as a Practical Nursing major.) 1C/1/0/0

PRNS 2491 Transition to Practice

In this course additional topics and skills are taught that relate to the professional scope of practice for the graduate practical nurse, demonstrating the progression from education to practice. Students will work in a clinical setting applying the knowledge, skills, attitude and the practice of safe effective care expected of the Practical Nursing graduate. They have progressed from a novice level to an accomplished level in the areas of communication, teamwork, problem-solving and the practice of safe effective care. In depth NCLEX-PN preparation is also emphasized in this course. Must earn a grade of "C" or better in this course to complete the program. (Prerequisite(s): Grade of "C" or better in all Nursing Program course requirements) 2C/1/1/0

PRNS 2492 Transition to Practice

In this course additional topics and skills are taught that relate to the professional scope of practice for the graduate practical nurse, demonstrating the progression from education to practice. Students will work in a clinical setting applying the knowledge, skills, attitude and the practice of safe effective care expected of the Practical Nursing graduate. They have progressed from a novice level to an accomplished level in the areas of communication, teamwork, problem-solving and the practice of safe effective care. In depth NCLEX-PN preparation is also emphasized in this course. Must earn a grade of "C" or better in this course to complete the program. (Prerequisite(s): Grade of "C" or better in all Nursing Program course requirements (PRNS 1425 Essentials of Clinical Pharmacology, PRNS 1435 Foundations of Nursing, PRNS 1481 Clinical I, PRNS 1521 Nursing Care of Adults I, PRNS 2411 Psycho/Social Nursing) (All prerequisites must have a minimum grade of 2.0 GPA equivalent). 3C/2/1/0

Psychology**PSYC 1710 General Psychology**

This course introduces psychological theory, experimental findings and applications of human behavior. Topics include research methodology, the nervous system, perception, cognition and memory, learning theory, human development, personality, emotions, attitudes, motivation, socialization and psychological disorders and related treatments. The course will explore current research and issues in psychology, including the influence of heredity and the environment on behavior. (Prerequisite(s): READ 0721 with a grade of "C" or better, or concurrent enrollment, or appropriate assessment score.) (MnTC: Goal 5) 4C/4/0/0

PSYC 1720 Psychology throughout the Lifespan

The focus of this course is on human development throughout the lifespan. The course includes research methodology, theoretical perspectives and the physical, cognitive and psychosocial changes that influence people throughout their development. An application of research and theory to current issues will be addressed. (Prerequisite(s): READ 0721 with a grade of "C" or better or appropriate assessment score) (MnTC: Goals 5 & 9) 3C/3/0/0

PSYC 1740 Abnormal Psychology

This course offers an integrated and multidimensional perspective of the study of psychopathology. Students learn about research methods, clinical assessment and diagnosis of psychological disorders using DSM codes as a reference. Students also explore the ways in which mental illness affects peoples' lives. (Prerequisite(s): PSYC 1710 General Psychology) (MnTC: Goals 5 & 7) 4C/4/0/0

PSYC 1750 Introduction to Health Psychology

This course examines how psychological, social and biological factors interact with and affect individuals' efforts to promote their own health and prevent or cope with illness. Topics include individual responses by gender, age and ethnicity; variations in health-related behaviors, stress and illness; whether, and what kind of, treatment individuals seek for health problems and whether they adhere to treatment recommendations; and the theories and methods used by psychologists to understand these issues. (Prerequisite(s): READ 0721 with a grade of "C" or better or appropriate assessment score) (MnTC: Goals 5 & 7) 3C/3/0/0

PSYC 1790 Special Topics in Psychology

This course is designed to present additional or unique material and learning experiences within a specified discipline. The course will be based on student need, flexibility, and may be designed to meet various transfer and pre-major course requirements. Please see a current Course Schedule for complete course details. (MnTC: Goal 5) Variable credits 1-6

PSYC 2720 Social Psychology

This course focuses on social psychological theories and research to analyze how an individual's thoughts, feelings, and actions influence other people, social settings, and institutions. Specific emphasis will be placed on the ways in which an individual's cognitive processes affect their emotions and behaviors as well as their interpretation of social interactions. Topics include perception, attribution, socialization, attitudes, conflict, altruism, groups, power, conformity, prejudice, collective behaviors, and social movements. (Prerequisite(s): PSYC 1710 or SOCI 1710. READ 0721 with a grade of "C" or better or appropriate assessment score.) (MnTC: Goal 5 & 7) 4C/4/0/0

Public Health**PUBH 1700 Personal and Community Health**

This course is designed to look at health from a personal, community, and populations perspective. Students will explore the many dimensions of health practices, behaviors, and concerns by covering topics such as, mental/emotional health, dietary practices, physical fitness, disease prevention and management guidelines, and health promotion. 3C/3/0/0

PUBH 1710 Consumer Health

Students will explore the selection, evaluation, and understanding of health information, medical services, advertising of products, health quackery, and socio-cultural factors revolving around consumer health. Students will learn basic knowledge and skills to navigate through consumer health issues, services, and products. 3C/3/0/0

PUBH 1790 Special Topics in Public Health

This course is designed to present additional or unique material and learning experiences within a specified discipline. The course will be based on student need, flexibility, and may be designed to meet various transfer and pre-major course requirements. Please see a current Course Schedule for complete course details. Variable credits 1-6

PUBH 2700 Public Health Overview

A foundation course that introduces students to the concept, history and practice of public health. The course examines the environmental, social, political and behavioral determinants of health and disease from a population perspective. It also looks at options for intervening to maintain the public's health through the use of the health care, public health, environmental health, and safety systems as well as laws and taxation. (Prerequisite(s): Any Goal 1 COMM or instructor approval) 3C/3/0/0

PUBH 2710 Public Health Education

This is a foundations course in health education and promotion for health educators. Students will learn the theories and models of health education, promotion, behavior change, and health promotion within government, worksites, public health agencies, and community organizations. Students will also explore determinants of disease, health, prevention, and interventions. (Prerequisite(s): READ 0722 with a grade of "C" or better or appropriate assessment score) 3C/3/0/0

PUBH 2720 Global Health

This course introduces key principles and concepts of global health. Students will examine how culture, human rights, economics, policies, and health care systems contribute to the global burden of disease and health promotion. In addition to traditional methods of assessment, this course will emphasize oral presentations. (Prerequisite(s): READ 0722 with a grade of "C" or better or appropriate assessment score) 3C/3/0/0

PUBH 2730 Public Health Administration

This is a foundational course in health policy and management related to the delivery, quality, and cost of healthcare for individuals and populations. Students will explore local health professional

training requirements, health insurance systems, the organization and management within public health settings and how they are influenced by politics. 3C/3/0/0

PUBH 2740 Environmental Health

This course is an introduction to the identification and analysis of environmental influences on health. Students will explore major environmental threats to health found in the house, air, water, solid waste, toxic waste, sanitation, and land use, as well as laws, policies, and practices associated with their control in the US and around the world. 3C/3/0/0

PUBH 2750 Public Health Advocacy & Leadership in Action

Take your public health education knowledge to the next level. In this course, students will develop an understanding of advocacy and their personal leadership style within public health promotion and education. Students will be prepared to participate within a community organization addressing a health issue important to them. Students will focus on the ways in which advocacy and leadership are connected to the assessment, planning, and implementation of health education and promotion programs. (Prerequisite(s): PUBH 2710) 3C/3/0/0

PUBH 2770 Public Health Practicum

This course is designed to provide public health students with 80 hours of worksite experience in the community. Students will apply public health knowledge throughout the program under the supervision of a public health professional. Students will have a shared responsibility in choosing the worksite, participating in appropriate worksite tasks, and reporting on their experience. (Prerequisite(s): Instructor approval) 2C/0/0/2

Reading

READ 0721 Reading 1

This course emphasizes comprehension and learning strategies necessary to respond effectively to a variety of college texts, readings and assignments. The course focuses on identifying main ideas, supporting details, organizational patterns typically found in college texts, summarizing, and developing college level vocabulary. (Placement into this course will be according to college assessment score.) 3C/3/0/0

READ 0722 Reading 2

This course emphasizes critical reading strategies and college level vocabulary. It presents college reading as information processing and focuses on strategies for improving comprehension, selection, organization and recall. Materials represent a variety of academic disciplines and occupational areas. (Placement into this course will be according to assessment score or successful completion of READ 0721 with a grade of "C" or better.) 3C/3/0/0

READ 0724 Fast Track Reading

This course fulfills the developmental reading requirements for the college-level courses in one semester. This accelerated course provides instruction in developing an active and critical reading approach to college-level texts, emphasizing the relationship between reading and thinking, as well as analysis and synthesis of multiple sources. Content includes strategic and academic vocabulary building, paraphrasing and summarizing, responding to and interpreting texts, developing research skills, increasing reading stamina, and improving comprehension. (Prerequisite(s): Accuplacer score of 38 or better). 5C/5/0/0

READ 0725 Vocabulary Development

This course emphasizes strategies and practice to build college-level and major-specific vocabulary, including guessing meaning from context, and identification of Latin/Greek roots and word parts. The course presents a variety of methods to increase reading, writing,

and speaking vocabularies, as well as to foster lifelong vocabulary development. In addition to general academic vocabulary, students will build career-specific vocabulary through nonfiction and research reading in the major areas. 1C/1/0/0

READ 1490 Special Topics in Reading

This course is designed to present additional or unique material and learning experiences within a specified discipline. The course will be based on student need, flexibility, and may be designed to meet various transfer and pre-major course requirements. Please see a current Course Schedule for complete course details. Variable credits 1-6

Related Welding

RWLD 2621 Apprenticeship Pipe Weld 1

The intent of the course is to teach uphill pipe welding. The weld procedure will be a 6010 root pass and a 7018 fill and cover pass. Six-inch schedule 40 carbon steel pipe will be the practice and test material used. Ninety percent of the class time will be spent in the weld shop and ten percent will be in a classroom setting with lectures and demonstrations. Upon completion of the course, the student/welder will know how to fit up, tack up, and weld out a set of pipe coupons in 2G, 5G, and 6G positions. Additionally, the student/welder will know how to make a root repair, describe the numbers on the electrodes, give an approximate weight of six-inch pipe, and be able to give the proper take-off dimensions for 90-degree and 45-degree weld fittings. 2C/0/2/0

RWLD 2622 Apprenticeship Pipe Weld 2

This is a course on welding carbon steel pipe in position. Areas covered include: cutting, beveling, prepping pipe, proper line-up technique prior to applying tack welds, welding out pipe joint in various positions, proper use and safety of welding equipment. (Prerequisite(s): Must be enrolled in Pipefitters Apprenticeship Training Program). 2C/0/2/0

RWLD 2623 Apprenticeship Pipe Weld 3

This is a course on welding carbon steel pipe in position. Areas covered include: cutting, beveling, propping pipe, proper line-up technique prior to applying tack welds, welding out pipe joint in various positions, proper use and safety of welding equipment. (Prerequisite(s): Must be enrolled in Pipefitters Apprenticeship Training Program). The emphasis will be on the student to have the basic understanding of pipe welding in position and how to set up and operate welding machines. They will also have the knowledge and eye-hand coordination to complete a carbon steel pipe weld in a fixed position. 2C/0/2/0

RWLD 2624 Apprenticeship Pipe Weld 4

Fourth year pipe fitter apprentices will learn how to take a UA welding tests in accordance with the UA procedure. (Prerequisite(s): Must be enrolled in Pipefitters Apprenticeship Training Program). 2C/0/2/0

RWLD 2660 Apprenticeship Pipe Welding 1 –Advanced

Upon completion of the course, the student/welder will know how to fit up, tack up, and weld out a set of pipe coupons in 2G, 5G, and 6G positions. Additionally, the student/welder will know how to make a root repair, describe the numbers on the electrodes, give an approximate weight of six-inch pipe, and be able to give the proper take-off dimensions for 90-degree and 45-degree weld fittings. Students will build on their knowledge and skills learned in Apprentice Pipe Welding 1. In addition, they will acquire the knowledge of tests parameters for ASME piping specs. 2C/0/2/0

RWLD 2661 Apprenticeship Pipe Welding 2 – Advanced

This is a course on welding carbon steel pipe in position. Areas covered include: cutting, beveling, prepping pipe, proper line-up technique prior to applying tack welds, welding out pipe joint in

various positions, proper use and safety of welding equipment position. Emphasis will be on the basic understanding of pipe weld in a fixed position. (Prerequisite(s); Must be enrolled in Pipefitters Apprenticeship Training Program). 2C/0/2/0

RWLD 2662 Apprenticeship Pipe Welding 3 – Advanced

The student will be able to perform and heliarc pipe weld in 2, 5, and 6G positions. 2C/0/2/0

RWLD 2663 Apprenticeship Pipe Welding 4 – Advanced

Orbital weld procedure. Students will program a variety of orbital weld machines for various piping entities. Students will understand the equipment and where to acquire necessary information and materials for the correct procedures and applications required for oil refineries, nuclear power house, food grade and pharmaceutical industries. 2C/0/2/0

Respiratory Therapist

RESP 1411 Respiratory Care Essentials

This course introduces the basic sciences and concepts required for the study of Respiratory Care. This includes fundamentals of chemistry, cardiopulmonary anatomy, physiology, mathematics, physics, and an introduction to the equipment used in basic respiratory care. An introduction to the sim lab and patient's medical record will be provided. Must earn a grade of "C" or better in this course to proceed. (Prerequisite(s): Acceptance into the program major. Must be taken concurrently with RESP 1412) 2C/1/1/0

RESP 1412 Respiratory Care Essentials Lab

This introductory lab course provides a hands on experience with basic oxygen devices and equipment used in the practice of Respiratory Care. This will take place in the lab and simulation center. Vital signs, oxygen and pulse oximetry competencies will be done. Must earn a grade of "C" or better in this course to proceed. (Prerequisite(s): Must be taken concurrently with RESP 1411) 1C/0/1/0

RESP 1510 Cardiopulmonary Pathophysiology 1

This course is an introduction to the assessment and pathophysiology of the patient with cardiopulmonary disease. Emphasis is on assessment of oxygenation, ventilation and acid-Base balance. Students are introduced to pulmonary pathophysiology emphasizing differences in obstructive and restrictive lung disease. Must earn a grade of "C" or better in this course to proceed. (Prerequisite(s): CHEM 1711, HLTH 1410, BIOL 1730, RESP 1411 and 1412) 3C/1/2/0

RESP 1521 Respiratory Care Therapeutics

This course introduces the student to basic respiratory care therapeutics including: oxygen administration, aerosol delivery devices, bronchial hygiene methods and lung hyperinflation techniques. Specific equipment, indications, contraindications, and adverse reactions associated with each therapeutic procedure are covered. Must earn a grade of "C" or better in this course to proceed. (Prerequisite(s): CHEM 1711, RESP 1411 and 1412, BIOL 1730; Co-Requisite(s): RESP 1522, RESP 1540) 4C/3/1/0

RESP 1523 Respiratory Care Therapeutics Lab

This course provides demonstrations and hands on practice in the use of equipment and procedures required for basic Respiratory Care Therapeutics. This will take place in a supervised lab and SIM lab. Modalities included are High Flow, Small Volume Nebulizer, Hyperinflation Therapy, Bronchial Hygiene Therapy and Airway Management. Must earn a grade of "C" or better in this course to proceed. (Prerequisite(s): RESP 1412; Co-requisites RESP 1521) 2C/0/2/0

RESP 1540 Respiratory Care Pharmacology

This is an in-depth course in cardiopulmonary pharmacology emphasizing drug classification, basic chemistry and action on tissue receptors. Describes indications, actions and dosages of drugs used in cardiopulmonary care. Must earn a grade of "C" or better in this

course to proceed. (Prerequisite(s): CHEM 1711, RESP 1411 and 1412, HLTH 1410 & BIOL 1730; Co-Requisite(s): RESP 1521 and 1522) 2C/1/1/0

RESP 1580 Introduction to Clinical

This course will introduce the student to the electronic medical record and requirements to start clinical' s the following semester. (Prerequisite(s): Entry to the Program; Co-requisite(s): RESP 1411, RESP 1412, and RESP 1540 1C/0/0/1

RESP 1581 Respiratory Care Clinical 1

Students will have direct patient contact and provide basic patient care procedures as directed by the clinic instructor. Emphasis is on data collection, application of oxygen, aerosol and humidification devices. Students will collect vital signs and practice physical assessment techniques. Students will record pertinent information in patient's computerized chart. Must earn a grade of "C" or better in this course to proceed. (Prerequisite(s): RESP 1411,1412, and RESP 1580) 3C/0/0/3

RESP 1582 Respiratory Care Clinical 2

A continuation of clinical practice procedures for administration of routine patient care therapy. Student will build on previous clinical experience. Emphasis is on bedside patient assessment, High flow, SVN, MDI and CPAP. Must earn a grade of "C" or better in this course to proceed. In conjunction with clinical, a hybrid element includes case discussions, research data and clinical practice guidelines to enhance learning development. Specific hospital based policies and practice while identifying the AARC Clinical Practice Guidelines (Prerequisite(s): RESP 1581, RESP 2410) 3C/0/0/3

RESP 1583 Respiratory Care Clinical 3

A continuation in clinical practice with emphasis given to acute care therapy. Mechanical ventilation and critical care skills are practiced and evaluated. In conjunction with clinical, a hybrid element includes case discussions, research data and evidence based clinical practice guidelines to enhance learning development. Specific hospital based policies and practice while identifying the AARC Clinical Practice Guidelines. Must earn a grade of "C" or better in this course to proceed. (Prerequisite(s): RESP 1582) 6C/0/0/6

RESP 1597 Respiratory Care Clinical 4

A continuation of clinical practice skills with emphasis on critical care monitoring and procedures. Students will rotate through pediatrics, long term care and adult critical care. Specialty rotations also are done this semester. Must earn a grade of "C" or better in this course to proceed. (Prerequisite(s): RESP 1593) 5C/0/0/5

RESP 1599 Respiratory Care Clinical 5

A continuation of clinical practice skills with emphasis on critical care time management at an Adult ICU of the students choosing. In conjunction with clinical, a hybrid element includes case discussions, research data and evidence based clinical practice guidelines to enhanced learning development. Students will also rotate through Pediatric ICU and Neonatal ICU. A sleep rotation in a sleep lab will also occur. Each clinical training during hospital rotations will be supported through student internship/specific hospital based regulations and practice while identifying the AARC Clinical Practice Guidelines. Must earn a grade of "C" or better in this course to proceed. (Prerequisite(s): RESP 1597) 4C/0/0/4

RESP 2411 Mechanical Ventilation

This is an introductory course in the use of mechanical ventilation. Positive and negative pressure machines are discussed, as well as other equipment and procedures related to mechanical ventilation. Methods of monitoring ventilator patient response to therapy are also described. Must earn a grade of "C" or better in this course to proceed. (Prerequisite(s): RESP 1510, RESP 1521, RESP 1522, RESP 1540, RESP 1591; Co-Requisite(s): RESP 1592) 3C/1/2/0

RESP 2412 Mechanical Ventilation Lab

This course provides hands-on practice in the clinical application and safety of mechanical ventilation. This will take place in a supervised lab. Must be taken concurrently with RESP 2411 Mechanical Ventilation. Must earn a grade of “C” or better in this course to proceed. 1C/0/1/0

RESP 2420 Cardiopulmonary Pathophysiology 2

This course continues the study of cardiopulmonary pathophysiology. Emphasis is placed on specific obstructive, restrictive and hemodynamic abnormalities. Must earn a grade of “C” or better in this course to proceed. (Prerequisite(s): RESP 1510; Co-Requisite(s): RESP 1592) 1C/0/1/0

RESP 2430 Neonatal/Pediatric Respiratory Care

This course introduces the student to principles of neonatal and pediatric respiratory care. Must earn a grade of “C” or better in this course to proceed. (Prerequisite(s): RESP 2420) 2C/1/1/0

RESP 2440 Management of the Critically Ill Patient

This is an advanced course in mechanical ventilation and medical management of the critically ill patient. Must earn a grade of “C” or better in this course to proceed. (Prerequisite(s): RESP 2411, 2412, and RESP 2420; Co-Requisite(s): RESP 1593) 4C/1/3/0

RESP 2450 Cardiopulmonary Diagnostics

This course will examine cardiopulmonary function studies, the techniques used and the significance of the individual tests with regard to pulmonary disease. Must earn a grade of “C” or better in this course to proceed. (Prerequisite(s): RESP 2420) 1C/0/1/0

RESP 2452 Advanced Simulation

This hybrid course is designed to train allied health program students in advanced critical care life support skills in a medical simulation lab setting. Students will be evaluated and observed on independent and team approach skills in a diverse simulation competency based scenario. Students will be assessed on skills based competencies on mock simulation patients in the lab, case study and scenario discussions. Students will be videotaped while they perform skills. Students must earn a grade of “C” or better in this course to proceed. (Prerequisite(s): RESP 2440; Co-Requisite(s): BLS Card through AHA) 3C/0/3/0

RESP 2458 Multidisciplinary RT

This course reviews the multidisciplinary positions in respiratory care and management skills/position that is essential towards understanding an organizational environment and a healthcare manager’s ability to perform various functions. This course will review the challenges of respiratory care professions and when necessary, classical theory and concepts. This curriculum will focus on relatively new concepts and trends in organizational management. An Online Research review will incorporate evidence based medicine and learner based theory concepts to promote concepts of respiratory care management. It is designed to help develop a solid base of understanding of the traditional core management functions of planning, decision making, organizing, staffing and decision making as well as the emerging functions of coaching, counseling, teaching and facilitating. In addition, students will also review different specialties and alternative sites in Respiratory Care. (prerequisite(s): RESP 2440; co=requisites: RESP 2452) 1C/0/1/0

RESP 2470 Registry Review

This course is an advanced study in Respiratory Care Procedures and prep for the NBRC CRT and RRT exam. Each student will need to successfully pass an entry level CRT self-assessment exam at the end of the course. Must earn a grade of “C” or better in this course to proceed. (Prerequisite(s): RESP 2411, RESP 2412, and RESP 1593) 3C/1/2/0

RESP 2510 Survey of Human Disease

This is a course in human pathology in which all body systems will be studied in relation to common diseases. This course is designed to assist the respiratory care student to acquire a basic knowledge of pathology required for the practice of respiratory care. Must earn a grade of “C” or better in this course to proceed. (Prerequisite(s): RESP 2411 and 2412) 2C/1/1/0

Sheet Metal

SMET 1410 Sheet Metal Fitting Layout & Design

Covers sheet metal layout using parallel line development, radial line development and triangulation. Duct design and sizing will be included. 4C/2/2/0

SMET 1415 OSHA 30 HR Training

Students will be given information on fire, ladders, scaffolding, electrical, cranes and personal protective equipment. Students will be trained in welding shop, sheet metal shop and field safety practices. 2C/2/0/0

SMET 1420 Sheet Metal Fitting Fabrication

Covers the procedures used to fabricate sheet metal fittings. Common seams and fasteners will be described. 4C/1/3/0

SMET 1430 Sheet Metal Drafting & Blueprint Reading

Covers principles of mechanical drawing. Students will interpret sheet metal blueprints. 2C/1/1/0

SMET 1440 Sheet Metal Welding

Covers the four processes used to weld sheet metal: Oxyacetylene, Shielded Metal Arc Welding, Gas Metal Arc Welding (Wirefeed) and Gas Tungsten Arc Welding (Tig or Heliarc). 5C/1/4/0

SMET 1450 Sheet Metal Practical Problem Solving

This course covers math used in the sheet metal trade. 2C/1/1/0

SMET 1510 Duct System Layout & Design

Covers the layout and design of duct systems used for HVAC and industrial ventilation systems. (Prerequisite(s): SMET 1410, SMET 1415, SMET 1420, SMET 1430, SMET 1440, SMET 1450) 4C/2/2/0

SMET 1520 Duct System Fabrication

Covers the fabrication and assembly of various types of duct systems. (Prerequisite(s): SMET 1410, SMET 1415, SMET 1420, SMET 1430, SMET 1440, SMET 1450) 4C/1/3/0

SMET 1530 Architectural Sheet Metal

Covers the fabrication and assembly of various types of architectural sheet metal systems. Installation techniques will also be described. (Prerequisite(s): SMET 1410, SMET 1415, SMET 1420, SMET 1430, SMET 1440, SMET 1450) 4C/2/2/0

SMET 1540 Power Machine Operation

Covers the fabrication of sheet metal items using the power shear, press brake, power rolls, punch press and spotwelder. (Prerequisite(s): SMET 1410, SMET 1415, SMET 1420, SMET 1430, SMET 1440, SMET 1450) 3C/1/2/0

SMET 1550 Sheet Metal CAD/CAM Systems

Covers the setup and operation of plasma cutting systems and computer-aided drafting systems. (Prerequisite(s): SMET 1410, SMET 1415, SMET 1420, SMET 1430, SMET 1440, SMET 1450) 3C/1/2/0

Sociology

SOCI 1710 Introduction to Sociology

This course introduces students to sociology: the systematic study of human interaction and society. Major theoretical perspectives and research methods of sociology will be examined. The primary goal is to create an awareness of, and appreciation for, the range of social and cultural variations throughout the United States and worldwide, stressing characteristics shared by all people. Readings and social science examples will be drawn from cultures around the world, including the pluralistic culture of the United States. Another focus of the class is to dispel common myths and stereotypes surrounding society and human behavior. (Prerequisite(s): READ 0721 with a grade of “C” or better or appropriate assessment score.) (MnTC: Goals 5 & 7) 4C/4/0/0

SOCI 1720 Social Problems

This course introduces students to modern issues of societal concern, including social problems that have endured over time and those that have emerged as societies modernize and cultures change. The influence of globalization on cultures around the world will be discussed. Specific topics include: inequalities of race, class, gender, age, and sexual orientation, modern family issues, crime and violence, drugs, war and terrorism, global health, environmental factors affecting society and culture, poverty, and population growth. Critical thinking skills will be developed through class discussions, debates, and course assignments. (Prerequisite(s): READ 0721 with a grade of “C” or better or appropriate assessment score.) (MnTC: Goals 5 & 8) 3C/3/0/0

SOCI 1730 Sociology of Families and Relationships

This course introduces students to the central ideas, challenges, theoretical perspectives and the diversity of human relationships, marriages and families. Global perspectives regarding families and the diversity of intimate relationships in contemporary societies will be discussed. Topics in this course could include the origins of marriage and diverse patterns of love, conflict, sexuality, parenting, singlehood, interpersonal violence, divorce, extended families and gender roles. Reading and examples will be drawn from societies around the world. Common myths and challenges related to stereotypes of the “typical” family and “functional” relationships will be explored. Critical thinking skills will be developed through class discussions, debates and course assignments. (Prerequisite(s): READ 0721 with a grade of “C” or better or appropriate assessment score.) (MnTC: Goals 5 & 7) 3C/3/0/0

SOCI 1740 Sociology of Work

Sociology of Work introduces students to theories, issues and perspectives about work and workplaces in a global economy. The course explores occupations and professions in historical and contemporary settings. The interdependence of economic, social and political factors that shape and change the nature of work are covered within a global context. (Prerequisite(s): READ 0721 with a grade of “C” or better or appropriate assessment score.) (MnTC: Goals 5 & 8) 3C/3/0/0

SOCI 1760 Mass Media and Society

This course provides students with a general understanding of how mass media operates in society and the influence of media messages in the areas of print media, recordings, radio, film, advertising, public relations, digital media and the Web. The course will emphasize basic definitions and the functions of mass media forms and practices; the impact of mass media on society; and major theoretical perspectives and research methods of society will be used to analyze various examples of media. Specific areas of discourse explored in this course may include racism, sexism, heterosexism, ageism, stereotypes, discrimination, violence, and crime. (Prerequisite(s): READ 0721 with a grade of “C” or better or appropriate assessment score) (MnTC: Goal 5) 4C/4/0/0

SOCI 1765 Sociology of Crime and Deviance

This course will offer students an introduction to the sociological study of crime and deviance. We will examine the major types of crimes, such as violent crime, property crime, cybercrime, white-collar crime, and organized crime. This course will cover major sociological theories used to explain crime and deviance. Students will also learn about the relativity of deviance, how power, social control, and labeling are used to socially construct definitions of deviance, and the consequences of being labeled deviant. Topics in deviance may include suicide, mental illness, obesity, body modification, substance abuse, and sexual diversity. (Prerequisite(s): READ 0721 with a grade of “C” or better or appropriate assessment score) (MnTC: Goals 5 & 7) 3C/3/0/0

SOCI 1766 Juvenile Delinquency

This course is designed to familiarize students with the sociological study of juvenile delinquency in the United States, while simultaneously cultivating an historical and international perspective on delinquency. Topics include the nature of delinquency, means of measuring delinquency, theoretical understandings of delinquency, societal influences upon and responses to delinquency, as well as the development of the juvenile justice system. (Prerequisite(s): READ 0721 with a grade of “C” or better or appropriate assessment score) (MnTC Goals: 5 & 9) 3C/3/0/0

SOCI 1772 Introduction to Criminal Justice

This course will introduce students to the major components of the American Criminal Justice System, specifically the police, corrections and the courts. Students will discuss the various types of crime and how crime is measured. Additional topics may include: a brief history of crime and punishment, the development of the criminal justice system, causes of crime and victimization, styles of policing, levels of the court system, philosophies of punishment, juvenile justice and prison life. (Prerequisite(s): READ 0721 with a grade of “C” or better or appropriate assessment score) (MnTC: Goals 5 & 9) 3C/3/0/0

SOCI 1774 Introduction to Corrections

This is an introductory course designed to provide students with an overview of the problems and ethical dilemmas that face America’s correctional system. The institution of corrections is not only a study of our prison system but is, in fact, the study of a complex network of societal relationships and institutions. This course examines the history, present, and future of U.S. corrections. The role of penitentiaries, prisons, jails, and grass roots organizations is explored along with the concepts of punishment, rehabilitation, retribution, restoration and transformation. (Prerequisite(s): Grade of “C” or better in READ 0721 or appropriate assessment score) (MnTC: Goals 5 & 9) 3C/3/0/0

SOCI 1776 Probation, Parole and Alternative Sentencing

This course is designed to introduce students to the fields of probation and parole. We will examine a variety of community-based correctional practices and strive to understand the roles of individuals who work within community programming. Most importantly, we will begin to gain an understanding of those individuals who receive the services of these fields. The ultimate goal of this course is for students to develop their ability to critically examine a diverse range of correctional programming. (Prerequisite(s): Grade of “C” or better in READ 0721 or appropriate assessment score) (MnTC: Goals 5 & 9) 3C/3/0/0

SOCI 1790 Special Topics in Sociology

This course is designed to present additional or unique material and learning experiences within a specified discipline. The course will be based on student need, flexibility, and may be designed to meet various transfer and pre-major course requirements. Please see a current Course Schedule for complete course details. (Prerequisite(s): READ 0721 with a grade of “C” or better or appropriate assessment score.) (MnTC: Goal 5) Variable credits 1-6

SOCI 2720 Social Psychology

This course focuses on social psychological theories and research to analyze how an individual's thoughts, feelings, and actions influence other people, social settings, and institutions. Specific emphasis will be placed on the ways in which an individual's cognitive processes affect their emotions and behaviors as well as their interpretation of social interactions. Topics include perception, attribution, socialization, attitudes, conflict, altruism, groups, power, conformity, prejudice, collective behaviors, and social movements. (Prerequisite(s): PSYC 1710 or SOCI 1710. READ 0721 with a grade of "C" or better or appropriate assessment score.) (MnTC: Goal 5 & 7) 4C/4/0/0

Spanish

SPAN 1710 Beginning Spanish 1

An introduction to Spanish based on real-life situations, as well as an introduction to various aspects of Hispanic societies. Comprehension and basic speaking skills are emphasized. Some reading and writing is required. The overall goal of this course is to provide students with the linguistic foundation necessary to later achieve proficiency in the Spanish language. No previous knowledge of Spanish is necessary. (Prerequisite(s): READ 0721 with a grade of "C" or better or appropriate assessment score) (MnTC: Goal 8) 5C/4/1/0

SPAN 1720 Beginning Spanish 2

A continuation of SPAN 1710. Emphasis is on extending skills in everyday spoken Spanish. (Prerequisite(s): SPAN 1710 with a grade of "C" or better or Placement Exam or instructor approval) (MnTC: Goal 8) 5C/4/1/0

SPAN 1730 Intermediate Spanish 1

This course provides continued development of communication in reading, writing, listening and speaking. There is an emphasis on communicating ideas in writing and conversation. As a part of the course, students will be exposed to the cultures of Spanish-speaking people through art, literature and history. (Prerequisite(s): SPAN 1720 with a grade of "C" or better or Placement Exam or instructor approval) (MnTC: Goals 6 & 8) 5C/4/1/0

SPAN 1740 Intermediate Spanish 2

This course is a continuation of SPAN 1730. The course provides continued development of communication in reading, writing, listening and speaking. There is an emphasis on communicating ideas in writing and conversation. As a part of the course, students will be exposed to the cultures of Spanish speaking people through art, literature and history. This course is usually offered during the spring term (Prerequisite(s): SPAN 1730 with a grade of "C" or better, or Placement Exam or instructor approval) (MnTC: Goals 6 & 8) 5C/4/1/0

SPAN 1790 Spanish for the Workplace

An introduction to basic Spanish conversational communication focusing on the specific context and situations of the workplace. The aim of this course is to achieve a basic level of proficiency in conversational Spanish to exchange information and perform basic everyday tasks. This class may be offered for specific career industries such as the Hospitality or Healthcare industries. When this happens, the career industry will be specified in the title. No previous knowledge of Spanish is necessary. (Prerequisite(s): READ 0721 with a grade of "C" or better or appropriate assessment score) (MnTC: Goal 8) 3C/3/0/0

SPAN 1795 Special Topics in Spanish

This course is designed to present additional or unique material and learning experiences within a specified discipline. The course will be based on student need, flexibility, and may be designed to meet various transfer and pre-major course requirements. Please see a current Course Schedule for complete course details. (MnTC: Goal 8) Variable credits 1-6

Supply Chain Logistics

BSLM 1410 Transportation Management

Introduction to basic transportation concepts and the relevance of transportation in our economy. Characteristics of each mode of transportation including rail, highway, carrier pricing, pipelines, air and water will be discussed and evaluated. 3C/3/0/0

BSLM 1510 Distribution Management

Designed to clarify and define the primary role of warehousing and logistics in today's economy. This course includes inventory control, material handling equipment, just-in-time productivity and quality control. 3C/3/0/0

BSLM 2420 Supply Chain Management

Supply chain management provides training in the areas of efficient administration and control of logistical components: transportation, inventory, packaging, warehousing, materials handling, customer service and their eventual integration into a logistics system. 4C/4/0/0

BSLM 2450 Procurement Principles and Applications

The course covers a broad overview of the objectives of Procurement; its authority, responsibility, management function and expectations. Students learn how and why the procurement function has far-reaching effects on a company's profit or loss. Procurement is a dynamic business function and is important in controlling costs in large dollar expenditures. The Procurement department deals with Production, Engineering, Marketing, Sales, Logistics, Stores, Inventory Control, Transportation, Quality Assurance and Finance. The primary objective of procurement is to buy the right materials, of the right quality, in the right quantity, at the right time, at the right price, from the right source. 3C/3/0/0

BSLM 2491 Business Logistics Management Internship

Students who participate in an internship gain first-hand knowledge in the industry under the guidance of a faculty member and a worksite supervisor. Students must state their goals and planned outcomes to participate in an internship. (Prerequisite(s): Instructor approval) Variable credits 1-3

BSLM 2497 Business Logistics Management Special Topics

The intent of this course is to allow flexibility in providing learning experiences to meet a special need of the student, the major program and the College. (Prerequisite(s): Instructor approval) Variable credits 1-3

Surgical Technology/Sterile Processing

SURG 1405 Introduction to Surgical Technology

This course provides a broad study of the operative environment, professional roles, moral/legal/ethical responsibilities, and medical communications used in surgical technology. (Requires concurrent enrollment in SURG 1410 & SURG 1415) 1C/1/0/0

SURG 1410 Sterile Processing

The course will introduce various surgical instruments, the classification and use(s), including the process of cleaning, decontamination, disinfection, and sterilization of equipment and supplies used in the surgical services department. Distribution and management of supplies to all customer service areas is also addressed for health care settings. (Prerequisite(s): BIOL 1471, BIOL 1740, BIOL 2721; Co-requisite(s): SURG 1415 and BIOL 2722) 3C/2/1/0

SURG 1415 Surgical Microbiology

This course addresses natural and artificial body defense mechanisms and the methods by which infectious diseases are recognized, treated, transmitted, and prevented. Disinfection and sterilization are also included. Content covers the application of aseptic technique and various environmental controls. (Prerequisite(s): BIOL 1471, BIOL 1740, BIOL 2721; Co-requisite(s): SURG 1410 and BIOL 2722)

SURG 2405 Pharmacology

Learners will review basic math skills and learn a framework of pharmacological principles in order to apply them safely in a surgical environment. These will include metric system, percentages, and proportions for medication calculations. Commonly used medication with surgical applications are reviewed in depth. These include antibiotics, diagnostic agents, diuretics, drugs that affect coagulation, ophthalmic agents, perioperative medications, anesthesia agents for both local and general anesthesia. Specific topics include drug administration routes and methods, blood and fluid usage, drug reactions including malignant hyperthermia and allergic reactions. (Prerequisites: SURG: 1405, 1410, 1415, and TEAS score of 60% or higher) 2C/2/0/0.

SURG 2410 Pathology & Procedure

This course reviews the pertinent anatomy and physiology related to the following surgical systems/specialties. General surgery, obgyn, orthopedics, ear nose throat (ENT), ophthalmic, neuro and spine, cardio-thoracic, peripheral vascular, urology, maxillofacial head neck, plastics, pediatrics, and robotics/laser. Conditions that warrant surgical correction are discussed in depth. Also introduced are common specialized instruments by type, function, and name. Relevant supplies are discussed specific to each surgical system. Common procedures in each of the surgical specialty areas are explained in depth; to include indication, anatomy involved, incision(s), patient positioning, prepping, draping, and equipment utilized. (Prerequisites: SURG 1405, 1410, 1415) 5C/4/1/0

SURG 2415 Operating Room Lab 1

Learners will practice the concepts and theories learned in 2410 Pathology and Procedures and 2405 Pharmacology. Basic skill sets will be put into practice for scrub gown and gloving (both open and closed), draping of the surgical patient, as well as set up appropriate instrumentation on back-table and mayo stand for general surgery abdominal cases. Focus will be on use of correct sterile technique, surgical consciousness, and communication by way of working within a team in the surgical environment. Learner will be able to practice passing instruments, load surgical blades and needles, and properly change contaminated gown and gloves. A focus will be around labeling drugs properly that will be used in the sterile field. (Prerequisites: SURG 1405, 1410, 1415) 5C/0/5/0

SURG 2420 Operating Room Lab 2

Learners will directly build on skill sets learned in SURG 2415, as they bring in more complex procedures to their training, from the curriculum in SURG 2410, these are then practiced directly in the lab session. The procedures will require new skill sets in the areas of draping, specialty equipment, instruments, and team communication. (Prerequisites: SURG 1405, 1410, 1415) 5C/0/5/0

SURG 2425 Operating Room Clinical 1 & 2

Students are assigned to a pre-planned clinical facility and assist with surgical procedures within the operative setting under the personal supervision of a clinical preceptor. This clinical practicum is designed for the student to integrate knowledge and theory from previous classes specific to Surgical technology, to develop skill set specific to that of a practicing Surgical Technologist. Clinical assignments are based on a set of weekly clinical performance objectives that must be met prior to the completion of the semester. Objectives are detailed for each week and they are designed to progress the student along by building on skill sets and knowledge already acquired to move them into more advanced cases requiring new skills and knowledge with instruments, equipment, and case studies.

Students will participate in biweekly clinical conferences to debrief current learning and synthesize knowledge with practice. Students will also have an opportunity to meet with instructor staff to discuss any events that may have occurred while on clinical, such as personality conflicts, specific situations with staff or surgeons, or case specific questions they might have. Also covered in the bi weekly conference are professional development topics, for resume building, interviewing skills and practice sessions, and the current trends in applying for a job as a Surgical Technologist. AST certification exam will be discussed and focused learning goals and techniques will be demonstrated for successful study of the AST exam. (Prerequisites: SURG 2405, 2410, 2415, 2420) 16C/0/16/0

Theatre and Drama

THTR 1710 Introduction to Theatre

This course introduces students to the study and exploration of theatre. Students will study the diversity of drama and explore the methods and styles of actors, directors, playwrights and designers. (MnTC: Goal 6) 3C/3/0/0

THTR 1716 Theatre Around the World

This course provides an introduction to the diverse theatrical styles and plays performed around the world. Students will explore a variety of theatre focusing on Eastern and Western cultures around the globe exploring the cultural, historical, social, religious, and linguistic significance of this work. Students will examine the aspects that go into creating these forms of theatre including, acting, design, and stagecraft. Students will explore these forms of theatre and their impact on theatre around the world today. (Prerequisite(s): READ 0722 with a grade of "C" or better or appropriate assessment score) (MnTC: Goals 6 & 8) 3C/3/0/0

THTR 1725 Acting 1

This course provides students an Introduction to Acting. Students engage in physical and vocal exercises training the actor's voice and body. Students will also develop the skills to respond critically to theatrical performances. Students engage in vocal and physical warm-ups and exercises, read and analyze plays, use improvisation towards developing characters in scenes from a variety of plays. (Prerequisite(s): Grade of "C" or better in READ 0722 or appropriate assessment score) (MnTC: Goal 6) 3C/3/0/0

THTR 1730 Theatre Stagecraft and Production

This course provides an introduction to Theatre Stagecraft and Production with units on acting, stage movement, set construction, painting, lighting, special effects, and scenic design, among other topics. Participation in current theatre production is required. This course may be repeated for credit. (MnTC: Goal 6) 3C/3/0/0

THTR 1731 Theatre Performance Practicum

Students who are interested in pursuing active participation as a performer in a Saint Paul College theatrical production will be eligible for this course. Students will take an active role as a live performer within a college production. This course may be replaced in subsequent terms for a maximum of 4 credits. (Prerequisite(s): Instructor approval) (MnTC: Goal 6) 1C/0/1/0

THTR 1732 Technical Theatre Practicum

Students who are interested in pursuing active participation as a technical worker in a Saint Paul College theatrical production will be eligible for this course. Students will take an active role as a technical worker within a college production. This course may be replaced in subsequent terms for a maximum of 4 credits. (Prerequisite(s): Instructor approval) (MnTC: Goal 6) 1C/0/1/0

THTR 1740 Fundamentals of Playwriting – Playwriting 1

This course focuses on the skills necessary for writers who write for the stage rather than the page. Students work to develop an ability

to create stage plots and dialogue. Through a series of writing and reading activities, exercises and assignments, students work to explore character, conflict and drama through their writing. Students also work through writing exercises to develop the skills to structure a play with a clear beginning, middle and end. Students are encouraged to develop their work and the course culminates in a reading of short plays. (Prerequisite(s): READ 0722 Reading 2 with a grade of "C" or better, or appropriate assessment score) (MnTC Goal: 6) 3C/3/0/0

THTR 1790 Special Topics in Drama and Theatre

This course is designed to present additional or unique material and learning experiences within a specified discipline. The course will be based on student need, flexibility, and may be designed to meet various transfer and pre-major course requirements. Please see a current Course Schedule for complete course details. (MnTC: Goal 6) Variable credits 1-6

THTR 2725 Acting 2

This course provides students continued study in acting skills. Students work to develop and exercise basic acting skills through practical application of the fundamental elements of the actor's art and work. Students will become more familiar with the actor's tools and a variety of acting techniques and the best ways to utilize them. Students engage in more detailed physical and vocal exercises training the actor's voice and body. Students read and analyze plays and develop character analysis and script analysis skills. Through acting exercises, activities, development of acting techniques, and scene work, students will develop the skills required to create three-dimensional characters in scene work. (Prerequisite(s): THTR 1725 Acting 1 or instructor approval) (MnTC: Goal 6) 3C/3/0/0

Truck Technician

TRKM 1400 Introduction and Safety

This course will introduce the student to the trucking industry and the role of the student as a truck technician within this industry. Personal, shop, tool and environmental safety will be emphasized. 1C/0/1/0

TRKM 1445 Truck Welding 1

Beginning course includes a combination of oxyacetylene welding, cutting, arc and MIG welding in a limited time. Basic shop procedures and safety are emphasized as is proper care of tools and equipment. Instruction will be conducted by lecture-demonstrations and shop practice. Practice on four basic joints in three basic positions is provided. Building an understanding and skill in the use of welding and manual cutting equipment are developed. 2C/0/2/0

TRKM 1455 Truck Welding 2

Continuation of skills developed in TRKM 1445. Includes advanced Arc and MIG welding techniques for frame repair in the trucking industry. Emphasis on safety procedures. 2C/0/2/0

TRKM 1521 Electrical 1

This course covers the design, theory of operation, repair procedures, and diagnosis of batteries, lighting systems, instruments and accessories used in commercial trucks. 5C/1/4/0

TRKM 1522 Electrical 2

This course covers the design, theory of operation, repair procedures and diagnosis of starting systems, charging systems and an introduction to electronic systems used in commercial trucks. 5C/1/4/0

TRKM 1551 Clutch and Transmission

This course covers the design, theory of operation, repair procedures, and diagnosis of clutches and manual transmissions used in commercial trucks. 5C/1/4/0

TRKM 1552 Driveshafts and Differentials

This course covers the design, theory of operation, repair procedures and diagnosis of drive shafts and differentials used in commercial trucks. 4C/1/3/0

TRKM 1553 Automatic and Automated Transmission

This course covers the design, theory of operation, repair procedures, and diagnosis of automated manual transmissions and automatic transmissions used in commercial trucks. 4C/1/3/0

TRKM 1560 Truck Brake Systems

This course covers the design, theory of operation, repair procedures, and diagnosis of hydraulic and air brake systems used in commercial trucks. 6C/1/5/0

TRKM 2401 Steering and Suspension Systems

This course covers the design, theory of operation, repair procedures, and diagnosis of steering, suspension and chassis components used in commercial trucks. 6C/1/5/0

TRKM 2425 Truck Cab Climate Control Systems

This course covers the design, theory of operation, repair procedures, and diagnosis of the heating, ventilation and air conditioning systems used in commercial trucks. 3C/1/2/0

TRKM 2440 Gasoline Engines

This course covers the design, theory of operation, repair procedures, and diagnosis of gasoline engine fuel and ignition systems used in commercial trucks. Engine overhaul procedures will also be covered. 6C/1/5/0

TRKM 2511 Diesel Engines 1

This course covers the design, theory of operation, repair procedures, and diagnosis of diesel engines used in commercial trucks. 6C/1/5/0

TRKM 2512 Diesel Engines 2

This course covers the design, theory of operation, repair procedures, and diagnosis of mechanical and electronic fuel systems used on diesel engines in commercial trucks. 6C/1/5/0

TRKM 2540 Preventive Maintenance

This course covers the preventive maintenance practices used to keep commercial trucks and trailers in proper and safe working order. Shop procedures, record keeping, computer use and job seeking skills will also be covered. 3C/1/2/0

Welding Technology

WLDG 1401 Industrial Shop Practices 1

This core course covers all the required safety instruction for all the 1400 category welding processes and the related shop equipment used. Instruction on welding equipment set-up and parameter settings along with welding theory will be covered for all welding processes. Students will be able to identify and demonstrate proper safety practices and usage on shop and welding equipment. (Co-Requisite(s): WLDG 1400-1450 will be taken in succession within the same semester block) 2C/2/0/0

WLDG 1402 Industrial Shop Practices 1

This core course covers all of the safety instruction for the 1400 level welding courses and shop equipment that will be used during the first semester. Students will demonstrate safe practices while using welding and shop equipment. Students will also identify the characteristics of mild steel. (Co-Requisite(s): WLDG 1402-1450 will be taken in succession within the same semester block) 4C/4/0/0

WLDG 1410 Welding Basics

This introductory course will cover shop safety practices, the theories and concepts necessary for an understanding of basic oxyacetylene welding, cutting and brazing processes. Emphasis will be on safe work habits based on current industry standards. It will also cover carbon arc and plasma arc cutting. (Co-Requisite(s): WLDG 1400-1450 will be taken in succession within the same semester block) 2C/0/2/0

WLDG 1420 SMAW: E6010

This course covers the introduction of the theories and concepts necessary for the SMAW process using the E6010 electrode in the various welding positions, according to current industry and AWS standards. Instruction on the use, care and safety practices of SMAW equipment will also be emphasized. (Co-Requisite(s): WLDG 1400-1450 will be taken in succession within the same semester block) 2C/0/2/0

WLDG 1430 SMAW: E7018

Covers the manipulative skills and procedures required to attain entry level proficiency of E7018 Shielded Metal Arc welds in all positions. Weld plate testing procedures will be offered allowing the student the opportunity to achieve qualification. (Co-Requisite(s): WLDG 1400-1450 will be taken in succession within the same semester block) 3C/0/3/0

WLDG 1431 SMAW: E7018

This course covers more advanced techniques of the SMAW weld process using the E7018 electrode. Students will learn to weld using proper technique and will judge their welds. Students will be exposed to the qualification process using weld plate testing procedures. An emphasis will be put on safety while using the SMAW equipment. (Co-requisite(s): WLDG 1441, WLDG 1420, WLDG 1410, WLDG 1402 WLDG 1450) 2C/0/4/0

WLDG 1440 GMAW Short Arc

Provides students with the opportunity to build proficiency in the GMAW (Gas Metal Arc Welding) process using the short arc transfer on mild steel. All positions will be covered. Students will be expected to work to industry and AWS standards for apprentice welders in the area of quality and efficiency. (Co-Requisite(s): WLDG 1400-1450 will be taken in succession within the same semester block) 2C/0/2/0

WLDG 1441 SMAW: Short Arc

This course is an introduction to the GMAW process using short circuit transfer. Students will learn to weld using proper technique and will judge their welds. An emphasis will be put on safety while using the GMAW equipment. (Co-requisite(s): WLDG 1402, WLDG 1410, WLDG 1420, WLDG 1431 WLDG 1450 will be taken in succession within the same semester block) 3C/0/6/0

WLDG 1450 Intro to Blueprint/Measuring Devices

This course is designed to cover such fundamental principles of drawing interpretation as may be required by a layout welder and setup person. To accomplish this objective, basic lines and blueprint viewing functions are studied and projects are assigned to reinforce base knowledge. This course also covers the use of different measuring devices used in the welding trades. (Co-Requisite(s): WLDG 1400-1450 will be taken in succession within the same semester block) 3C/3/0/0

WLDG 1501 Industrial Shop Practices 2

This core course covers all the required safety instruction for all the 1500 category welding processes and the related shop equipment used. Instruction on welding equipment set-up and parameter settings along with welding theory will be covered for all welding processes. Students will be able to identify and demonstrate proper safety practices and usage on shop and welding equipment. (Prerequisite(s): Must complete 1st semester core group 1400-1450 prior to advancing to 2nd semester core group 1500-1540; Co-Requisite(s): WLDG 1500-1540 will be taken in succession within the same semester block) 2C/2/0/0

WLDG 1502 Industrial Shop Practices

This core course covers all the required safety instructions for all the 1500 category welding processes and the related shop equipment used. Instruction on welding equipment set-up and parameter settings along with welding theory will be covered for all welding processes. Students will be able to identify and demonstrate proper safety practices and usage on shop and welding equipment. (Prerequisite(s): Must complete 1st semester core group 1402-1450 prior to advancing to 2nd semester core group 1502-1540) (Co-requisite(s): WLDG 1510, WLDG 1520, WLDG 1530, WLDG 1540) 4C/4/0/0

WLDG 1510 GMAW Spray and Pulse Spray

Provides students with the opportunity to build proficiency in the GMAW process using the spray and pulse spray transfers on mild steel. All positions will be covered. Students will be expected to work to industry standards for apprentice welders in the area or quality and efficiency. Weld testing plate procedures will be offered allowing the student the opportunity to achieve qualification. (Prerequisite(s): Must complete 1st semester core group 1400-1450 prior to advancing to 2nd semester core group 1500-1540; Co-Requisite(s): WLDG 1500-1540 will be taken in succession within the same semester block) 3C/0/3/0

WLDG 1520 GMAW Core Wires

Designed to build proficiency in FCAW, FCAW-G, Metal Core and SAW processes. The student will be expected to perform to industry standards as required for apprentice welders. Weld plate testing procedures will be stressed, allowing the student the opportunity to achieve qualification. (Prerequisite(s): Must complete 1st semester core group 1400-1450 prior to advancing to 2nd semester core group 1500-1540; Co-Requisite(s): WLDG 1500-1540 will be taken in succession within the same semester block) 3C/0/3/0

WLDG 1530 Intro to GTAW

Provides students with the opportunity to build proficiency in the GTAW process on mild steel in all positions. The student will be expected to work to industry and AWS standards for apprentice welders in the area of quality and efficiency. (Prerequisite(s): Must complete 1st semester core group 1400-1450 prior to advancing to 2nd semester core group 1500-1540; Co-Requisite(s): WLDG 1500-1540 will be taken in succession within the same semester block) 3C/0/3/0

WLDG 1540 Blueprint Welding Symbols/Math/Welder Qualification

This course will focus on the knowledge of welding symbols as specified by the American Welding Society, (AWS). Welding inspection and welder qualification procedures will also be covered. (Prerequisite(s): Must complete 1st semester core group 1400-1450 prior to advancing to 2nd semester core group 1500-1540; Co-Requisite(s): WLDG 1500-1540 will be taken in succession within the same semester block) 3C/3/0/0

WLDG 2401 Industrial Shop Practices 3

This core course covers all the required safety instruction for all the 2400 category welding processes and the related shop equipment used. Instruction on welding equipment set-up and parameter settings along with welding theory will be covered for all welding processes. Students will be able to identify and demonstrate proper safety practices and usage on shop and welding equipment. (Prerequisite(s): Must complete 1st & 2nd semester core groups 1400-1540 prior to advancing to 3rd semester core group 2400-2440; Co-Requisite(s): WLDG 2400-2440 will be taken in succession within the same semester block) 2C/2/0/0

WLDG 2402 Industrial Shop Practices 3

Students will perform mathematical problems and apply it to metal working problems/situations they may encounter on the job site. (Prerequisite(s): Must complete 1st and 2nd semester core groups 1402-1540 prior to advancing to 3rd semester core group 2402-2442) (Co-requisite(s): WLDG 2411, WLDG 2420, WLDG 2430, WLDG 2442) 4C/4/0/0

WLDG 2410 GMAW Aluminum and SST

Provides students with the opportunity to build proficiency in the GMAW process using both Aluminum and Stainless Steel. The introduction of the Aluminum and Stainless numbering system will be covered. Students will be expected to perform to industry and AWS standards as required for apprentice welders in the areas of quality and efficiency. (Prerequisite(s): Must complete 1st & 2nd semester core groups 1400-1540 prior to advancing to 3rd semester core group 2400-2440; Co-Requisite(s): WLDG 2400-2440 will be taken in succession within the same semester block) 2C/0/2/0

WLDG 2411 GMAW: Aluminum & Stainless Steel

Students have the opportunity to build proficiency in the GMAW process using Aluminum & Stainless Steel in various weld positions. The student will create welds to industry standards on Stainless-Steel and Aluminum. (Prerequisite(s): Must complete 1st & 2nd semester core groups 1402-1540 prior to advancing to 3rd semester core group 2402-2442). (Co-requisite(s): WLDG 2402, WLDG 2420, WLDG 2430, WLDG 2442) 3C/0/3/0

WLDG 2420 GTAW Aluminum and SST

Provides students with the opportunity to build proficiency in the GTAW process using aluminum & stainless steel in various weld positions. Aluminum & Stainless numbering systems will also be reviewed. Students will be expected to perform to industry and AWS standards as required for apprentice welders in the areas of quality and efficiency. (Prerequisite(s): Must complete 1st & 2nd semester core groups 1400-1540 prior to advancing to 3rd semester core group 2400-2440; Co-Requisite(s): WLDG 2400-2440 will be taken in succession within the same semester block) 4C/0/4/0

WLDG 2430 Grinding and finishing

Designed to create an in-depth knowledge of abrasives and equipment used in the welding & fabricating industry. Students will gain proficiency in both grinding and high grade finishing on various base materials according to paint, food and pharmaceutical standards. (Prerequisite(s): Must complete 1st & 2nd semester core groups 1400-1540 prior to advancing to 3rd semester core group 2400-2440; Co-Requisite(s): WLDG 2400-2440 will be taken in succession within the same semester block) 2C/1/1/0

WLDG 2441 Intro to Robotic Welding and Fabrication

Designed as an introduction to robotic welding as it applies to manufacturing. Students will be given specified projects in order to develop fabrication techniques used in industry. (Prerequisite(s): Must complete 1st & 2nd semester core groups 1400-1540 prior to advancing to 3rd semester core group 2400-2440; Co-Requisite(s): WLDG 2400-2440 will be taken in succession within the same semester block) 2C/0/2/0

WLDG 2442 Introduction to Robotics

Student will be introduced to basic Robotic/CNC machine processes as it applies to manufacturing. Students will be given specified projects in order to develop fabrication techniques used in industry. (Prerequisite(s): Must complete 1st & 2nd semester core groups 1402 & 1540 prior to advancing to 3rd semester core group 2402-2442) (Co-requisites: WLDG 2402, WLDG 2411, WLDG 2420 & WLDG 2430) 3C/0/3/0

WLDG 2500 2D CAD

This course introduces the practices and procedures for the use of Radan software in the Fabrication field. Students will be required to work within industry standards for 2D CAD blueprint drafting. (Prerequisite(s): Must complete 1st, 2nd & 3rd semester core groups 1400-2440 or receive instructor approval prior to advancing to 4th semester Advanced Certificate 2500-2570; Co-Requisite(s): WLDG 2500-2570 will be taken in succession within the same semester block) 2C/2/0/0

WLDG 2510 Safety

Designed to give students safety and operational instruction on all shop equipment required in the 2500 series certificate. Students will demonstrate correct safety procedures required in all the automated fabrication processes. (Prerequisite(s): Must complete 1st, 2nd & 3rd semester core groups 1400-2440 or receive instructor approval prior to advancing to 4th semester Advanced Certificate 2500-2570; Co-Requisite(s): WLDG 2500-2570 will be taken in succession within the same semester block) 1C/1/0/0

WLDG 2520 CNC Plasma

This course is designed to expose the student to CNC functions utilizing M & G coding Editing and perform CNC programing functions. Students will use proper safety equipment set up procedures and perform CNC operations according to industry standards. (Prerequisite(s): Must complete 1st, 2nd & 3rd semester core groups 1400-2440 or receive instructor approval prior to advancing to 4th semester Advanced Certificate 2500-2570; Co-Requisite(s): WLDG 2500-2570 will be taken in succession within the same semester block) 2C/1/1/0

WLDG 2530 Press Brake Operations

Designed to build proficiency in sheet metal fabrication the student will be expected to work within industry standards using math formulas, bend allowances and measuring instruments as required for apprentices. Students will program the CNC press to achieve correct bending outcomes to industry requirements. (Prerequisite(s): Must complete 1st, 2nd & 3rd semester core groups 1400-2440 or receive instructor approval prior to advancing to 4th semester Advanced Certificate 2500-2570; Co Requisite(s): WLDG 2500-2570 will be taken in succession within the same semester block) 3C/1/2/0

WLDG 2540 Robotic Welding Operations

Designed to build proficiency in fabrication skills beyond the previous diploma courses. The student will be expected to work within Industry standards as for apprentice fabricators using robotic programing, set up procedures, trouble shooting and repair of robotic functions. (Prerequisite(s): Must complete 1st, 2nd & 3rd semester core groups 1400-2440 or receive instructor approval prior to advancing to 4th semester Advanced Certificate 2500-2570; Co-Requisite(s): WLDG 2500-2570 will be taken in succession within the same semester block) 3C/1/2/0

WLDG 2550 Industrial Equipment

Designed to build proficiency in the metal fabricating field, the student will be expected to perform within industry standards for apprentice welders/fabricators. The student will be introduced to lifting devices which are encountered in live work situations, using fork truck and overhead cranes. (Prerequisite(s): Must complete 1st, 2nd & 3rd semester core groups 1400-2440 or receive instructor approval prior to advancing to 4th semester Advanced Certificate 2500-2570; Co-Requisite(s): WLDG 2500-2570 will be taken in succession within the same semester block) 2C/1/1/0

WLDG 2560 Layout Practices

Course 2560 will allow the student to demonstrate knowledge of manufacturing layout and planning through designated projects. These projects will require the student to use advanced techniques in design, layout and fabrication processes used in industry. (Prerequisite(s): Must complete 1st, 2nd & 3rd semester core groups 1400-2440 or receive instructor approval prior to advancing to 4th semester Advanced Certificate 2500-2570; Co-Requisite(s): WLDG 2500-2570 will be taken in succession within the same semester block) 4C/1/3/0

WLDG 2570 Robotic Welding Capstone

Through this capstone offering, students will have the opportunity to meet specified credit requirements utilizing shop experiences approved by the overseeing Instructor. (Prerequisite(s): Must complete 1st, 2nd & 3rd semester core groups 1400-2440 or receive instructor approval prior to advancing to 4th semester Advanced Certificate 2500-2570; Co-Requisite(s): WLDG 2500-2570 will be taken in succession within the same semester block) 1C/0/1/0

WLDG 2590 Welding Special Projects

The intent of this course is to allow flexibility in providing learning experiences to meet a special need of the student, the major program and the College. (Prerequisite(s): Instructor approval) Variable credits 1-4

Women's and Gender Studies

WGST 1785 Foundations in Women's Studies

This course serves as an introduction to the field of women's and gender studies. Using an interdisciplinary approach, the course examines the conditions and circumstances affecting the lives of (primarily) women in the United States. The course explores the roles that women play in society, with careful attention to the ideas and factors that shape those roles. Students will examine how ideas about gender (as well as race, ethnicity, social class, sexual orientation, physical ability and age) are informed by institutions, cultural beliefs, and social practices. Throughout the course, emphasis is placed on the diversity of women's experience in contemporary United States and connections to women worldwide. (Prerequisite(s): READ 0721 with a grade of "C" or better or appropriate assessment score) (MnTC: Goals 5 & 9) 3C/3/0/0

WGST 1790 Special Topics in Women's and Gender Studies

This course is designed to present additional or unique material and learning experiences within a specified discipline. The course will be based on student need, flexibility, and may be designed to meet various transfer and pre-major course requirements. Please see a current Course Schedule for complete course details. (MnTC: Goals 5 & 9) Variable credits 1-6

Stakeholders

Minnesota State Colleges and Universities Board of Trustees

AbdulRahmane Abdul-Aziz

State University Student

(Term Dates: October 24, 2017 - June 30, 2018)

Ashlyn Anderson

Technical College Student

(Term Dates: July 15, 2018 - June 30, 2020)

Alexander Cirillo, Jr.

Congressional District 6

Legislative District 56A

(Term Dates: August 6, 2012 – June 20, 2024)

Jay Cowles, Vice Chair

Congressional District 4

Legislative District 64A

(Term Dates: August 26, 2014 – June 30, 2020)

Dawn Erlandson

Congressional District 5

Legislative District 60A

(Term Dates: August 6, 2012 – June 30, 2018)

Robert Hoffman

Congressional District 1

Legislative District 24A

(Term Dates: August 26, 2014 – June 30, 2020)

Jerry Janezich

Congressional District 8

(Term Dates: August 24, 2016 – June 30, 2022)

Roger Moe, Treasurer

Congressional District 7

(Term Dates: December 20, 2016 – June 30, 2020)

April Nishimura

Congressional District 2

(Term Dates: July 15, 2018 - June 30, 2024)

Rudy Rodriguez

Congressional District 3

(Term Dates: August 24, 2016 – June 30, 2022)

George Soule

At Large

(Term Dates: July 15, 2018 - June 30, 2024)

Louise Sundin

Congressional District 5

(Term Dates: August 24, 2016 – June 30, 2020)

Cheryl Tefer

Congressional District 6

Legislative District 53A

(Term Dates: August 24, 2016 – June 30, 2022)

Michael Vekich, Chair

Congressional District 6

(Term Dates: August 24, 2016 – June 30, 2022)

Samson Williams

Community College Student

(Term Dates: July 15, 2018 - June 30, 2020)

President's Advisory Council

Gaye Adams Massey

YWCA

Cecile Bedor

CommonBond Communités

David Berg

South St. Paul Steel Supply Co., Inc.

June Berkowitz

Nina's Coffee

Chris Bidlack

Saint Paul College Student Senate President

Daniel Bostrom

Saint Paul City Council

John Brodrick

Saint Paul Board of Education

Gregory Buck

Productivity Incorporated

Dan Cherryhomes

Minnesota Teamsters Service Bureau

Jennifer Christensen

UFCW 1189

Emmanuel Donaby

Science Museum of Minnesota

Jean Echternacht

University of Minnesota

Darren Ginther

St. Paul Public Schools

Paul Huot

Huot Manufacturing

Nate Keith

US Bank

Joseph Kroeger

Mayo Clinic

Lee Krueger

Saint Paul Port Authority

Theresa Malone

Associated Healthcare Credit Union

Tom McCarthy

St. Paul Plumbers Local #34

Rena Moran

Minnesota House of Representatives

Ryan O'Connor

Ramsey County

Mary Rothchild

Minnesota State Colleges and Universities

Patrick Ryan

Nanocopeia, Inc.

Mindy Travers

Shared Governance Council Representative

Kristin Schultes

Metropolitan Mechanical Contractors, Inc.

Erica Schumacher

Office of Ramsey County Attorney John J. Choi

Autumn M.E. Zehren

HealthEast Care System

Foundation Board of Directors

Ryan Caulfield '96*

Levy Restaurants

Sarah E. Crippen

Best & Flanagan

Kim Eagan

Regions Hospital

Jane Graupman

International Institute of Minnesota

Butch Howard

HMS Host

D. Ward Johnson

Retired, Tealwood Asset Management

Nathaniel Khaliq '72*

Retired, Saint Paul Fire Department

Saint Paul NAACP

Russell Klein

Meritage

Karin McCabe

McGough Construction

Larry Mohr

Baker Tilly Virchow Krause, LLP

Ross Nelson

Harris Companies

Mike Newman

Retired, Philanthropy Consultant

Marco Rodiles '14*

Finance of America

Jihan Rush Jenkins

Cargill, Inc.

Tony Samec

U.S. Bank

Zach Schwartz

Schwan's Food Service

Kevin Sevcik

Sunrise Banks

Linn K. Veltema

Frieslandia, LLC

Pamela Wellumson

ASLIS

Christine A. Wiegert

HDR, Inc.

Rassoul Dastmozd, PhD ex officio

President/CEO, Saint Paul College

Administration

Dastmozd, Rassoul

President/CEO

BET, Southwest Minnesota State University

MSEd, Drake University

PhD, Colorado State University

Ashby, Brendan L.

Dean of Health Sciences & Service

BA, University of Colorado at Denver

MPH, University of Denver

MBA, Regis University

PhD, Creighton University

Bergengren, Audrey

Executive Director of Marketing,

Communications & Recruitment

BS, MSU, Moorhead

MA, St. Catherine University

Carrico, Sarah

Dean of Academic Effectiveness & Innovation

BA, University of Wisconsin

MA, University of Maryland, College Park

Haarbusch, Rainer

Dean of Career & Technical Education

MA, University of Bayreuth

PhD, University of Bayreuth

King, Laura

Vice President of Student Affairs

BS, University of Wisconsin, River Falls

MSEd, University of Wisconsin, LaCrosse

PhD, University of Minnesota, Twin Cities

Kline, David

Executive Director of Friends

of Saint Paul College, Foundation

AA, North Hennepin Community College

BS, University of Minnesota, Minneapolis

MA, University of St. Thomas

Kubas, Andrew

Dean of Liberal & Fine Arts

BA, University of Minnesota

MS, North Dakota State University

PhD, North Dakota State University

Martin-Kerr, Keitha-Gail

Associate Dean of Faculty & Staff Development

BA, Northern Caribbean University

MA, City College of New York

MA, Touro College

PhD University of Minnesota

Raney, Kristen

Vice President of Academic Affairs

BA, St. Cloud State University

MSE, University of Wisconsin, Stout

EdD, Edgewood College

Roberson, Wendy

Dean of Student Success & Equity and Inclusion Officer

BS, Grand Valley State University

MA, Hamline University

Sachdev, Tarah

Interim Dean of Enrollment Management

BS, Minnesota State University, Mankato

MS, Minnesota State University, Mankato

Schmidt, Elizabeth

Business Manager

BS, American Intercontinental University

MBA, Benedictine University

Schmidt, Rachelle

Chief Human Resources Officer

BA, University of Minnesota, Duluth

MA, Saint Mary's University of Minnesota

Sorenson, Nichole

Dean of Institutional Research, Planning & Grants

BA, Concordia College, Moorhead

MA, University of Minnesota

Onunwor, Enyinda

Dean of Science, Technology, Engineering and Math

AA, Cuyahoga Community College

BS, Youngstown State University

MS, Youngstown State University

MA, Kent State University

PhD, Kent State University

Wilson, Scott

Vice President of Finance &

Operations/Chief Financial Officer

BS, William Carey College

MBA, William Carey College

Wilson, Tracy

Dean of Business and

Workforce Training & Continuing Education

BS, William Carey University

MBA, William Carey University

PhD, Mississippi State University

Academic/Student Support

Aweis, Qadar

Recruiter/Admissions Specialist
BA, State University of New York

Bergs, Thomas

Director of Public Safety
BA, University of St. Thomas

Bartlett, Julia

Coordinator, Curriculum & Assessment
BS, Northwestern Health Sciences University
DC, Northwestern Health Sciences University

Berry, Pam

Pathway Advisor
BA, Greenville College
MA, Washington University

Britton, Michelle

Pathway Advisor
BA, Metropolitan State University
MA, Saint Mary's University of Minnesota

Bruflat, Thomas

Coordinator, Co-Curricular Assessment
BA, University of Wisconsin, Madison
MS, Minnesota State University, Mankato

Butler, Sarah

Power of You & Make it Count, Director
BS, University of Wisconsin
MSE, University of Wisconsin
PhD, Capella University

Byers, Carl

Advising, Director
BA, Talladega College
MA, The University of Alabama
EdD, The University of Alabama

Cahill, Colleen

Student Activities Coordinator
BA, Beloit College
MA, Concordia University

Cheney, Jessica

Coordinator, Gender-Based Violence Prevention
BA, Grinnell College
MSW, University of Minnesota

Duff, Caitlin

One Stop Advisor
BA, University of Minnesota
MA, University of Minnesota

Engen, Kyra

Interim Multicultural Program Coordinator
BA, Hamline University

Gerold, Michael

Director, Student Rights & Responsibilities
BA, Hamline University

Hassan, Mohamed

Pathway Advisor
BA, St. Cloud State University
MS, St. Cloud State University

Huston, Jennifer

Director, Workforce Training & Continuing Education
BS, Brown College

Jacobson, Kelly

Director of Technical Services
BS, Metropolitan State University

Johnson, Adam

Financial Aid, Director
BA, Gustavus Adolphus College

Johnson, Scott

Pathway Advisor
BA, St. Olaf College
MA, Luther Seminary

Kittelson, Laura

Interim Director of Admissions, Records & Registration
BA, University of Wisconsin, Eau Claire
MS, University of Wisconsin, Stout

Kjellman, Mark

Director, Academic Support
BA, Bowling Green State University
MA, Auburn University
MTS, Boston University
PhD, Boston University

Lorendo, Thomas

One Stop Advisor
AAS, Minneapolis Community & Technical College
BS, Minnesota State University, Mankato

Miller, Gabriela

Outreach Coordinator
BA, Concordia College

Morgan, Andrea

Navigator, Power of You & Make it Count
BA, Gustavus Adolphus
MSc, University of Edinburgh

Academic/Student Support, continued

Myint, Carol

Coordinator, International Student
BS, State University of New York
MPA, Indiana University
MSES, Indiana University

Pickens-Opoku, Alicia

Director, One Stop Services
BA, Hamline University
MA, Ball State University

Pierre, Kathryn

Director of College Partnerships
AA, Century College
BA, University of Minnesota
MA, University of St. Thomas

Reid, Greg

Financial Aid
AAS, Inver Hills Community College
BA, Metropolitan State University

Rizvi, Bushra

Pathway Advisor
BS, Kinnaird College for Women
MS, University of Karachi

Robinson, Candace

Pathway Advisor
BHS, Metropolitan State University

Rodriguez, Claudia

Recruiter/Admissions Specialist
AAS, Saint Paul College

Roeller, Keri

One Stop Advisor
BA, Metropolitan State University

Saul, Sheryl

Director, Career Placement and Internships
Diploma, Alexandria Technical & Community College
BA, Metropolitan State University
MA, Saint Mary's University of Minnesota

Shah, Mela

Pathway Advisor
BA, Gustavus Adolphus College
MEd, University of Minnesota

Shingles, Lamar

Student Life, Director
MS, Central Michigan University
BA, Central Michigan University

Smridarov, James

Instructional Designer
BA, American University
MS, University College London

Thawmoo, George

Recruiter/Admissions Specialist
BA, Bangkok University

Thornton, Colleen

Financial Aid
AA, Normandale Community College

Trad, Kari

Navigator, TRIO
AA, Century College
BA, College of St. Catherine
MA, University of Minnesota

Vang, Gao

PSEO Coordinator
BS, University of Wisconsin-Oshkosh
MS, University of Wisconsin-Milwaukee

Vang, Mary

Director, TRIO
BS, University of Wisconsin, River Falls
MPNA, Metropolitan State University

Xiong, Mao

One Stop Associate
BS, University of Minnesota
MPNA, Metropolitan State University

Xiong, Nee Na

Director, Access & Disability Resources
BA, St. Catherine University

Yang, Mee

Pathway Advisor
BA, St. Olaf College

Yang-Moua, Bao

Financial Aid
BA, Metropolitan State University
MA, Walden University

Zimski, Jacquelyn

Navigator, Power of You & Make it Count
BA, Concordia College
MS, Minnesota State University

Faculty

Andresen, James

Political Science

BS, Minnesota State University, Mankato

MA, Minnesota State University, Mankato

PhD, Arizona State University

Anglin, Jennifer

Medical Office Careers

BS, University of Wisconsin, Superior

MA, College of St. Scholastica

MS, College of St. Scholastica

Babina, Lyubov

Esthetics

AAS, Saint Paul College—A Community & Technical College

MS, Lvov State Medical University

Bansal, Anita

Biology

BS, Meerut University

MS, Meerut University

MS, University of Illinois, Urbana-Champaign

Barshack, Evan

Business

BS, University of Baltimore

MBA, University of Baltimore

JD, University of Baltimore

Bohrer, Nick

Massage Therapy

AA, University of Minnesota

BS, University of Minnesota

Bommarito, Aaron

Art

BA, Kalamazoo College

MFA, Arizona State University

Bonnett, Justin

English

BA, Saint John's University

MA, University of St. Thomas

Briski, Michelle

Medical Laboratory Technician

BA, Hamline University

MEd, University of Minnesota

Buhain, Joseph

Respiratory Therapy

AS, Valencia College

AA, University of Central Florida

BA, Baker College

MBA, Aspen University

Byrne, Garrett

Machine Tool

AS, Chippewa Valley Technical College, Eau Claire, WI

Chahal, Harsimranjit

Chemistry

BS, Guru Nanak Dev University, India

MS, Guru Nanak Dev University, India

PhD, University of South Carolina

Chitwood, Brandon

English

BA, St. John's University

MA, Minnesota State University

PhD, Marquette University

Cooley, Sarah

Mathematics

BA, St. Olaf College

MS, University of Minnesota

Cregan, Joanna

Biology

BS, Beloit College

MS, University of Minnesota

Crispin, Mary

English

BA, University of Minnesota

MA, University of St. Thomas

D'Meier, Kristinea

Sociology

BA, University of Minnesota

MS, Minnesota State University, Mankato

Dale, Kelly

Medical Office Careers

BA, College of St. Scholastica

De La Cruz, Angela

Spanish Language

BA, Universidad de Costa Rica

MA, University of Northern Iowa

Duthie, Kasandra

English

BA, University of Minnesota

MFA, Minnesota State University, Mankato

Evans, Julie

Esthetics

BA, Saint Catherine University

MA, Saint Catherine University

Faculty, continued

Fleischman, Natasha

English and Reading
BS, University of Wisconsin
MA, Monterey Institute of International Studies

Gabrawy, Mariann

Biology
BS, St. Cloud State University
MA, St. Cloud State University

Gage, Patti

Reading
BA, University of Northern Colorado
MAT, School for International Training

Gibbons, Nora

Psychology
BA, University of St. Thomas
MA, University of Missouri, St. Louis
PhD, University of Missouri, St. Louis

Gielissen, James

Biology
BS, University of Wisconsin, Madison
MS, University of Minnesota

Gill, Linda

Interpreter Training Program
Certificate, Saint Paul College—
A Community & Technical College
BS, University of Minnesota

Goftarsh, Sasha

Mathematics
BA, A. I. Herzen State Pedagogical University
MA, A. I. Herzen State Pedagogical University

Gonyea, Amy

Biology Instructor
BA, Northwestern University
MPT, Northwestern University

Haider, Julie

Philosophy
BA, Valparaiso University
MA, Marquette University
MA, University of St. Thomas

Hanes-Goodlander, Lisa

Counselor
BA, Wright State University
MS, Wright State University
PhD, University of Minnesota

Hankel, Todd

Welding
Diploma, Hennepin Technical College

Hazen, Stephanie

Psychology
BA, Amherst College
MA, Boston College

Hillstead, Thomas

Cabinetmaking
Diploma, Saint Paul College—
A Community & Technical College

Hoisington, Emily

Art
BA, Bethel College
MFA, Minneapolis College of Art and Design

Hudson, Rachel

Biology
BA, Gustavus Adolphus College
MS, Iowa State University

Hulander, Kelly

English
BA, University of Minnesota
MA, University of Minnesota
PhD, University of Minnesota

Ignatjeva, Anna

Communication
BA, University of Latvia
MS, Minnesota State University, Mankato

Jacobs, Aaron

Art
BA, Minnesota State University, Moorhead
MFA, New York Academy of Art

Johnson, Ben

Machine Tool Instructor
Diploma, Saint Paul College

Johnson, Carla Elaine

English
BA, Randolph College
BA, University of Maryland, College Park
MA, State University of New York, Albany
MA, University of Minnesota
PhD, Ohio State University

Johnson, Rania

American Sign Language
BA, Metropolitan University
MEd, University of Minnesota

Faculty, continued

Jones, Sean

Culinary Arts

AAS, Saint Paul College—

A Community & Technical College

Kennedy, Barbara

English as a Second Language

BA, Macalester College

MA, University of Minnesota Twin Cities

Kerestech, Tatiana

Practical Nursing

AAS, Century College

BS, Metropolitan State University

Kokesh, Hannah

Pharmacy Technician

BA, Augsburg College

Kortenhof, Kurt

History

BA, University of Wisconsin, Eau Claire

MA, University of Wisconsin, Eau Claire

Kpanaku, Zubah

Chemistry

BS, Cuttington Univ. College – Liberia

MS, General Chemistry, Ohio University

MS, Analytical Chemistry, Ohio University

MS, Chemical Technology/Technician, Purdue University

Lawson, Peter

Economics

BS, Accounting, University of Wisconsin, Superior

BS, Economics, University of Wisconsin, Superior

MS, Utah State University

Leggs, Michael

English

BA, Kansas State University

MA, Kansas State University

LeMay, Victoria

Welding

Diploma, Saint Paul College—

A Community and Technical College

Lund, Bill

English

BA, Westmar University

MA, Ball State University

Massa, Janet

Child Development Careers

BS, University of Wisconsin, Stout

MA, Concordia College

Maus, Craig

Hospitality Management

AA, North Hennepin Community College

BA, Minnesota State University, Mankato

MBA, University of St. Thomas

Mazur, Celeste

Reading

BS, Michigan Technical University

MA, Hamline University

McKown, Kelly

Child Development Careers

BS, California State University

MS, University of Wisconsin, Stout

Mehmood, Nasreen

Biology

BS, Osmania University

MS, Osmania University

PhD, Osmania University

Mills, Travis

Chemistry

BS, St. Cloud State University

PhD, University of Minnesota

Mohler, Jolianne

Surgical Technology

Diploma, Anoka-Hennepin Technical College

Diploma, Minneapolis Business College

Nguyen, Francois

Mathematics

BA, University of St. Thomas

MEd, University of LaVerne

EdD, Saint Mary's University

Nordahl, Scott

Machine Tool Processes

Diploma, Austin Technical College

O'Halloran, James

Accounting

BS, Minnesota State University, Mankato

MBA, University of Minnesota

MBT, University of Minnesota

Olivier, Llewellyn

Automotive Services Technology

Diploma, Century College

Olsen-Sartain, Jennie

Reading

BS, University of Minnesota

MA, College of St. Catherine

Faculty, continued

Paborriboon, Viangsavanh

Sheet Metal Technology/HVAC Ducts & Fittings
Diploma, Saint Paul College

Paulnock, Daniel

Communication
BS, Emerson College
MS, Emerson College

Paulson, Caleb

Welding
Diploma, Saint Paul College—
A Community and Technical College

Pearson, Darren

Digital Graphics
BSEE, University of North Dakota
MS, University of Minnesota

Pearson, Joel

Truck Technician
Diploma, Dakota County Technical College

Pueringer, Kristin

Mathematics
BS, St. Olaf College
MS, University of Minnesota

Purcell, John

Automotive Service Technician
Diploma, Dakota County Technical College
AA, Inver Hills Community College

Purcell, Kirstin

Biology
BA, University of Minnesota
ME, University of Minnesota
MCLS, University of Maryland

Rafferty, Patrick

Truck Technician
Diploma, Saint Paul College—
A Community & Technical College

Rawlings, Mark

Computer & Information System Security
BS, St. Cloud State University
MEd, St. Mary's University

Reigstad, Shelby

Communication
BS, St. Cloud State University
MA, Bethel College

Roethke, Leigh

Art
BFA, Savannah College of Art & Design
MA, University of Minnesota

Russell, Judy

Respiratory Care Practitioner
AAS, Saint Paul College—
A Community & Technical College

Sartain, Jeremy

Massage Therapy
BA, University of Minnesota, Duluth

Sartain, Nathan

Culinary Arts
Diploma, Western Culinary Institute

Schaus, George

Electrical Technology
Diploma, Saint Paul College—
A Community & Technical College

Schlueter, John

English
BA, Loras College
MA, Loyola University
PhD, Loyola University

Schmitz, Lisa

Mathematics Psychology
BS, University of Wisconsin, River Falls
MS, University of Minnesota
MA, University of St. Thomas

Schroeder, Nicole

Medical Laboratory Technology
BS, University of Wisconsin, LaCrosse

Schumacher, Pamela

Engineering
BS, Texas A & M University
MS, Texas A & M University

Selton, Julie

Electrical Technology
AA, Anoka Technical College

Senger, Susan

Business
BA, College of Saint Scholastica
MA, College of Saint Scholastica

Setley, Keith

Electrical Technology
AA, Saint Paul College—
A Community & Technical College
BS, University of Wisconsin, Stout

Faculty, continued

Seymour, Joy

Practical Nursing
AA, Saint Paul College—
A Community & Technical College
AS, Saint Paul College—
A Community & Technical College
BS, Metropolitan State University
MS, Western Governors University

Shah, Avani

Mathematics
BS, Gujarat University
BS, Gujarat University
BEEd, Gujarat University
MBA, University of Phoenix
MS, University of Minnesota

Shariff, Ayesha

History
BA, North Central College
MA, University of Wisconsin, Madison
PhD, University of Wisconsin, Madison

Sheaffer, Warren

Computer Careers
BS, University of Pittsburgh
MBA, University of Pittsburgh
MST, Massachusetts Institute of Technology

Smith-Fields, Marcie

Cosmetology
AA, Globe College of Business
BS, Rasmussen College

Stambaugh, Jon

Business
BBA, University of Wisconsin, Superior
MBA, Metropolitan State University
EdD, Saint Mary's University of Minnesota

Starkey, Penny

Chemistry
BS, University of St. Thomas
PhD, University of Minnesota

Stueve, Mary

Biology
BS, University of Minnesota
MS, University of Minnesota

Su, Ba

Mathematics
BS, University of Wisconsin, River Falls
BS, Metropolitan State University
MS, Iowa State University

Sundlie, Jolene

Sociology
BA, Minnesota State University, Moorhead
MS, North Dakota State University

Swartwood, Jason

Philosophy & Humanities
BA, College of William and Mary
MA, University of Minnesota
PhD, University of Minnesota

Tarrell-Florey, Amy

English for Speakers of Other Languages
BA, Washington University in St. Louis
MA, University of Minnesota

Taylor, Natalya

Mathematics
BA, Russian A.I. Herzen State Pedagogical University
MA, Russian A.I. Herzen State Pedagogical University

Taylor, Susan

English
BA, California State University, Los Angeles
MFA, University of Minnesota

Ten Eyck, Samantha

English
BFA, New York University
MFA, Mankato State University

Tiffany, Chelsea

Physics
BA, Wellesley College
MS, University of Minnesota

Travers, Mindy

Business
AAS, Saint Paul College—
A Community & Technical College
BS, Saint Mary's University of Minnesota
MA, Hamline University

Trego, Shannon

Geography
BA, University of Wisconsin, Madison
MA, University of North Carolina, Chapel Hill

Tri, Ben

Librarian
BA, University of St. Thomas
MS, University of Wisconsin, Milwaukee
MPNA, Metropolitan State University

Faculty, continued

Tsegaw, Yewondwossen

Practical Nursing

Diploma, Saint Paul College—

A Community & Technical College

BS, Metropolitan State University

MSN, Walden University

Vainshtein, Alli

Business Technology Careers

BS, University of Phoenix

MBA, University of Phoenix

VanderWaal Mills, Kristyn

Biology

BS, University of Minnesota

PhD, University of Minnesota

Viertel, Viki

Surgical Technician

BS, Saint Mary's University of Minnesota

MS, Kaplan University

Vorderbruggen, David

Automotive Service Technician

Diploma, Saint Paul College—

A Community & Technical College

Weikle, Dean

Electrical Technology

Diploma, Minneapolis Community & Technical College

Weldearegay, Biniam

Practical Nursing

AS, Century College

BS, Minnesota State University, Mankato

Wheeler, Jody

English

AA, Ridgewater Community College

BA, Bemidji State University

MA, St. Cloud State University

Yernberg, Jacob

Automotive Service Technician

Diploma, Wyoming Technical Institute

Zimmerman, Maggie

Earth Science

BA, University of St. Thomas

MS, University of Illinois, Chicago

- A**
- Academic Forgiveness 11
 - Academic Probation 11
 - Academic Support 292
 - Academic Suspension 11
 - Academic Warning 11
 - Accounting 32-33, 34, 225
 - Accreditation 2, 5
 - Administration 291
 - Admissions 6
 - Alumni 5
 - American Sign Language 219, 220, 225
 - American Sign Language Studies 212-213
 - Anthropology 221, 226
 - Appeals 12
 - Application 6
 - Art 218, 226
 - Associate of Applied Science (AAS) 19
 - Associate of Arts 207
 - Associate of Fine Arts (AFA) 19
 - Associate of Fine Arts Degree – Music 210-211
 - Associate of Science (AS) 19
 - AutoCAD 6
 - Automation 89, 91-92
 - Automotive Service 64-65, 66-67, 228
- B**
- Background Checks 9
 - Biochemistry 170, 229
 - Biology 170, 172-173, 229
 - Board of Trustees 289
 - Business 5, 6, 31, 37, 39-40, 231, 233
- C**
- Cabinetmaking 70, 233
 - Career & Technical Education 63
 - Career Planning 240
 - Carpentry 71, 234
 - Center for Manufacturing & Applied Engineering 235
 - Certificate Programs 20
 - Chemistry 171, 174, 237
 - Child Development 147-148, 149-150, 151-152, 154, 238
 - Chinese 220, 239
 - CIDESCO Readiness 105
 - Clinical Sports Massage 137-138, 139
 - CNC Toolmaking 86, 239
 - Coaching 6
 - Communication 6, 215, 217, 240
 - Completion Rate 11
 - Computer Animation 182
 - Computer Applications 6
 - Computer Graphics and Visualization 178
 - Computer Network Engineering 191-192
 - Computer Programming 193-194
 - Computer Science 187-188, 241
 - Cosmetology 155-156, 157-158, 244
 - Course Add 10
 - Course Descriptions 224
 - Course Drop 10
 - Course Withdraw 10
 - Credit 8
 - Criminology 208
 - Culinary Arts 160-161, 162-163, 246
 - Culinary Arts - Wine 248
 - Culinary Foundations 164
 - Customer Service 6, 38
 - CyberSecurity 184-185, 186
- D**
- Data Science 203
 - Deferment Options 12
 - Developmental Coursework 20
 - Digital Graphics 248
 - Diploma Programs 20
 - Directions 303
 - Drama & Theatre 218, 219
- E**
- Economics 221, 222, 250
 - Educational Programs 18
 - Electrical Technology 72-73, 250
 - Electromechanical Systems 74, 75, 251
 - Employers 5
 - Engineering 169
 - Engineering (Pre) 252
 - Engineering Broad Field 176-177
 - English 217, 253

English for Academic Purposes (EAP) 20, 214, 217, 218, 255
 Entrepreneurship 6, 45
 Esthetician 96-97, 100-101, 102, 244
 Esthetician Advanced Practice 98-99, 103
 Esthetics for Cosmetologist 104
 Esthetics Re-licensure & Training 6
 Event and Meeting Management 53

F

Faculty 294
 Fees 12
 Finance. 46-47
 Financial Aid 12, 14, 15, 16, 17
 Financial Assistance 15
 Fine Arts 206, 218
 Foundation Board of Directors. 290

G

General Information. 5
 General Transfer Table 2019-2020. 29
 Geographic Information Science. 204, 205
 Geography 221, 222, 256
 Global Languages. 220
 Global Studies 257
 Global Trade 48-49, 50, 257
 Grade Point Average (GPA) 11
 Grants 15

H

Health 6, 257
 Health Information Technology 106-107
 Health Science 95
 Health Sciences Broad Field 115-116
 Healthcare Documentation Specialist. 114
 Healthcare Informatics. 108-109
 High School Articulated. 6
 History. 221, 222, 259
 History Transfer Pathway 216
 Home Health Aide 125, 270
 Hospitality Management 51-52, 260
 Human Resources 54-55, 56, 260
 Humanities. 218, 219, 261
 HVAC Ducts & Fittings. 81, 82

I

Immunizations 6
 Individualized Studies. 88, 261
 Industry 5
 Intake 6
 Interactive Multimedia. 248
 Internships 21
 Interpreter/Transliterater Sign Language 261

J

Java Programming 197-198

L

Leadership/Management 6
 Liberal Arts 206
 Liberal Arts and Sciences Associate of Arts (AA) 18
 Loans 15

M

Machine Operator (Right Skills Now) 87
 Machine Technologist 90
 Machining 91-92
 Management Information Systems 189-190
 Marketing 57-58
 Massage Therapy 140, 262
 Mathematics 169, 171, 263
 Medical Coding 112
 Medical Laboratory Technician 117-118, 264
 Medical Office 113, 266
 Medical Office Professional 110-111
 Minnesota State Colleges and Universities 5
 Minnesota Transfer Curriculum. 21, 23
 Mission 2
 Motorcycle Training 6
 Music. 219, 268

N

Nail Care 159, 244
 Natural Sciences. 171, 269
 Network Administration 195-196
 Nonprofit. 41
 Nursing Assistant. 125, 270

- O**
- Office Management Professional 35-36
 - One Stop 6
- P**
- Parking. 303, 304
 - Pastry and Baking 165
 - Patient Care Technician 121-122
 - Pharmacy Technician 126-127, 128-129, 270
 - Philosophy 219, 220, 271
 - Phlebotomy 119-120, 272
 - Physics 171, 273
 - Pipefitting. 76-77, 78-79, 273
 - Plumbing 80, 275
 - Political Science 221, 222, 276
 - Post-Secondary Enrollment Options (PSEO) 6
 - Practical Nursing 123-124, 276
 - President’s Advisory Council 289
 - Probation. 12
 - Production Technologies 93
 - Project Management 42-43, 44
 - Psychology 222, 223, 278
 - Public Health 130-131, 278
- Q**
- Quality Assurance 6
- R**
- Reading 217, 279
 - Records 10
 - Registered Yoga Teacher 145
 - Registration 10
 - Respiratory Therapist. 132-133, 280
 - Robotic Welding 85
- S**
- Safety 6
 - Saint Paul Joint Apprenticeship 21
 - Satisfactory Academic Progress 10, 11
 - Science 169, 175
 - Service 146
 - ServSafe® Certification 6
 - Sheet Metal 81, 82, 281
 - Sign Language Interpreter/Transliterater 167-168
 - Social Media Marketing. 59
 - Social Science. 221
 - Social Science/Public Affairs. 209
 - Sociology 222, 223, 282
 - Software Training 6
 - Spanish. 220, 221, 283
 - Sport and Exercise Sciences 141-142, 144
 - STEM. 169
 - Sterile Processing 136
 - Strategic Goals. 3
 - Student Support 292
 - Students 5
 - Supervisory & Management Training 6
 - Supply Chain Logistics. 60-61, 62, 283
 - Surgical Technology 134-135, 283
- T**
- Technology. 169
 - Theatre and Drama 284
 - Transcripts 10
 - Transfer 6, 7, 8, 28
 - Truck Technician 68-69, 285
 - Tuition 12, 14
- V**
- Values 2
 - Vision. 2
 - Visualization Technology 179-180, 181
- W**
- Web Based 2D Game Development 199-200
 - Web Design 183
 - Web Development 201-202
 - Welcome 1
 - Welding 6, 83, 84, 94, 285, 279
 - Wine Professional. 166
 - Withdrawal Period 14
 - Women’s and Gender Studies 222, 223, 288
 - Work-Study 15
 - Workers Compensation 6
 - Workforce Training & Continuing Education (WTCE) 5

Directions & Parking

Easy to Find. Easy to Get To.

From the South (35E)

Take the Kellogg Boulevard Exit, turn left. Continue to John Ireland Boulevard, turn left at the traffic light. Continue to Marshall Avenue, turn right.

From the North (35E) or From the East (I-94W)

Take the Marion Street Exit, turn left passing over the freeway. Continue on Kellogg Boulevard to John Ireland Boulevard, turn right at the traffic light. Continue to Marshall Avenue, turn right.

From the West (I-94E)

Take the Marion Street Exit, at the top of the exit ramp take a right onto Kellogg Boulevard. Turn right at traffic light onto John Ireland Boulevard. Continue to Marshall Avenue, turn right.

Bus Information

Saint Paul College is also easy to reach by bus. Please visit www.metrotransit.org for route information.

Visitor Parking

Visitor parking is available in any open, undesignated space in the Parking Ramp or Lot B, C, D or E. Enter parking lot via Marshall Avenue.

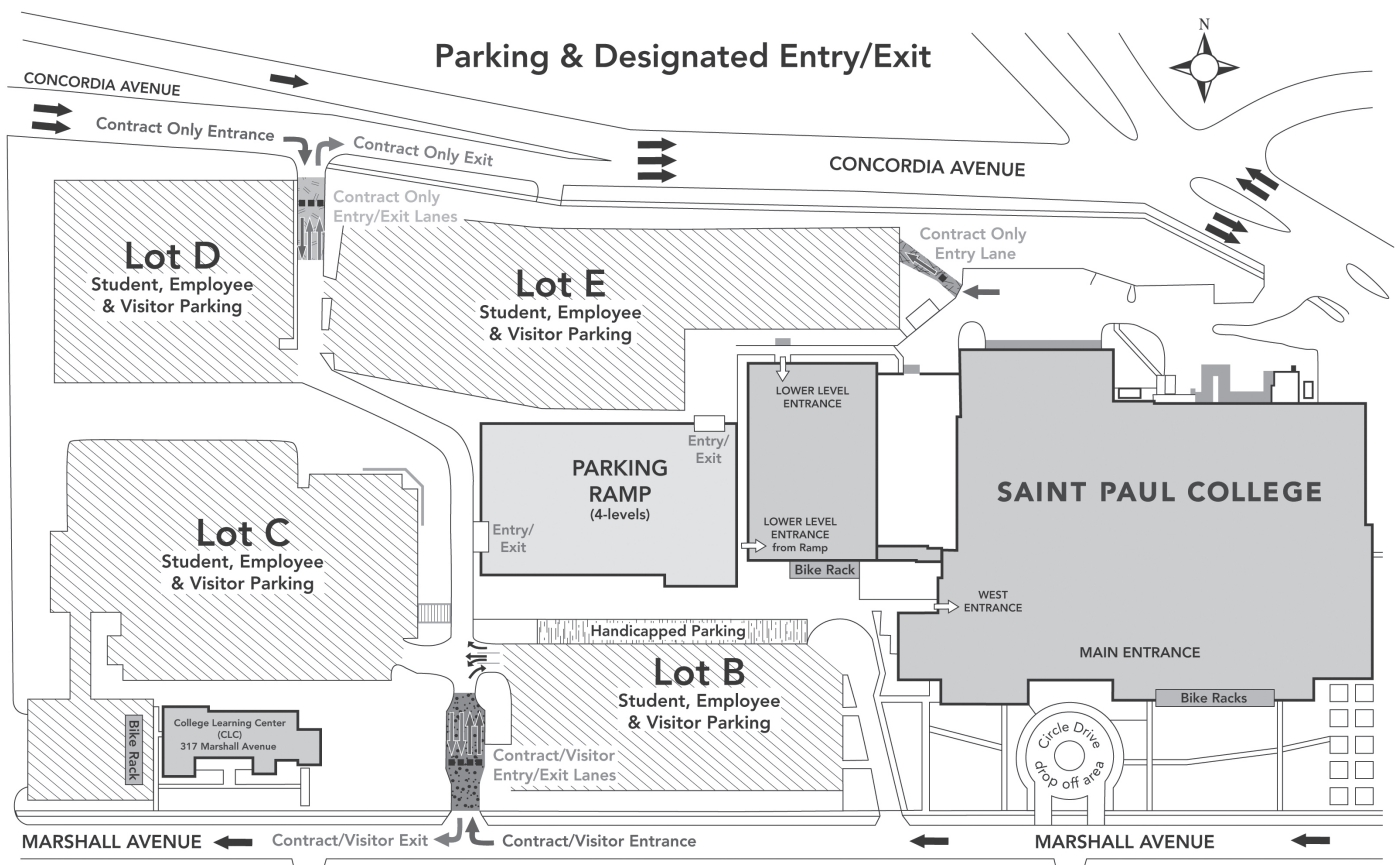

SAINT PAUL COLLEGE

A Community & Technical College

235 Marshall Avenue
Saint Paul, MN 55102

www.saintpaul.edu/parking

Map Legend

- Contract/Visitor Entry/Exit
- Contract Only Entry/Exit

Bike Racks

Visitors, students and employees may park in the Parking Ramp and Lots B, C, D & E.

11/2012

For the most up-to-date information about parking and fees, go to the College website: saintpaul.edu/parking

Parking Information

Parking Lots/Designated Parking Areas

Parking Policy

It is mandatory for all motor vehicles parked on the Saint Paul College campus to use the controlled parking access system. Visitors may park anywhere in the lots and ramp except for marked reserved spaces. Vehicles parked in handicapped parking spaces require a valid State-Issued Handicapped Permit. All violators will be ticketed.

Regulations

All persons operating a vehicle on campus are responsible for being familiar with, and complying with, all traffic and parking regulations. A complete list of parking violations and parking policy may be obtained from the Office of Public Safety on the first floor. Saint Paul College assumes no liability for care of, damage to, and/or protection of any vehicle or its contents at any time while it is operated on or parked on the campus property. Possession of a parking access card neither reserves nor guarantees a parking space.

Motorcycle Parking

Motorcycle parking is available in the designated parking areas by the Kellogg Boulevard and Marshall Avenue entrances. Visitors with motorcycles can park in either the upper or lower lot designated motorcycle parking area; however, visitors must use the Marshall Avenue entrance and then exit at Marshall Avenue by paying the hourly rate when leaving. The cement motorcycle parking areas are located to the left of the Kellogg Boulevard entrance in the lower lot and in the upper lots at the east end of Lot B.

No Parking Zones

- Any restricted parking space without a proper parking tag.
- Any handicapped space without a legally displayed sticker or license plate.
- Fire lanes. This includes leaving room for a minimum of two vehicles to pass at the end of each row.
- In front of any garage doors.
- Any Right-of-Way areas. This includes the area north of the Truck and Fabrication Shops to allow for oversized vehicle maneuvering.
- Any areas not paved or designated for parking. This includes sidewalks, curbs, and lawns.

If You Receive a Citation for a Parking Violation

Payment is to be directed to the Tuition Office and requires a copy of the citation. Payment is due fifteen (15) business days from the date the citation was issued. Checks are to be made payable to Saint Paul College. You may appeal your citation within fifteen (15) business days from the date the citation was issued. Appeal forms are available at the Public Safety Desk. The form must be filled out completely to be considered. If you fail to pay your parking citation(s), the fine(s) will be placed on your student record. If the ticket goes unpaid, a hold will be placed on your account and you will be unable to get a copy of your transcript or register until the fine is paid. Unpaid tickets will be processed through the college's normal collection process and the debt may be submitted to Minnesota Department of Revenue for collection.

It is mandatory that all motor vehicles parked on the Saint Paul College campus use the parking access system to go in and out of the parking lot.



SAINT PAUL COLLEGE

A Community & Technical College

start here. go anywhere.

235 Marshall Avenue
Saint Paul, MN 55102

651.846.1600
saintpaul.edu

©2019 Saint Paul College. All rights reserved.
Saint Paul College is an Equal Opportunity employer and educator.



MINNESOTA STATE

Saint Paul College,
A member of Minnesota State